

DANIEL
RUBINETTERIE
MILANO



COLLECTION

MADE IN ITALY



DANIEL
RUBINETTERIE

MILANO

COLLECTION
2 0 1 9



ANIMA E DESIGN
SOUL & DESIGN



FUSION P. 26 TOKYO P. 36 TOKYO STEEL P. 44 DIVA P. 50 SPEED P. 62 TIARA P. 70
SKYLINE P. 80 SUVI P. 96 OXY P. 118 JAX P. 128 KIR P. 134 TWIN P. 140

CONTEMPORANEO
CONTEMPORARY



OMEGA P. 148 SMART P. 162 OMEGA ECO P. 178 SMART ECO P. 182

CASCATA
E COLORE
WATERFALL
& COLOUR



SKYLINE AMBIENT P. 184 CUBE WATERFALL P. 188 OXY LIGHT P. 194 CEILING COLUMN P. 200

CLASSICA
CLASSIC



CRYSTAL P. 204 CRYSTAL RETRÓ P. 210 REVIVAL P. 216 RETRÓ P. 228
LIFE P. 236 MISS P. 242 TIME P. 248 TICINO P. 252

LIVING



VENUS P. 258 RIO P. 262 SERENA P. 266 CONTRACT P. 270
ECO P. 274 LEVA CLINICA LEVER HANDLESS P. 280 MINI P. 282 MINI 100 P. 286

INDICE INDEX

TERMOSTATICI
THERMOSTATICS



X-FACTOR P. 288



Q-FACTOR P. 296



SKYLINE THERMO P. 300



SUVI THERMO P. 308



OXYTHERMO P. 318



THERMO P. 324

LAVELLI
SINKS



LAVELLI - SINKS P. 328



ACQUA DEPURATA
PURIFIED WATER P. 336



TOUCH-ME P. 342



COLOUR &
AMBIENT P. 345



GOURMET P. 347

HI-TECH
SENSOR
TIMER



SENSOR P. 360



TEMPOR TOUCH P. 366



TEMPOR P. 370

IDROTERAPIA
WELLNESS
CROMOTERAPIA
WATERTHERAPY
WELLNESS
COLOURTHERAPY



BOX INCASSO
BUILT-IN BOX P. 376



WELLNESS KIT P. 382



CROMOTERAPIA
COLOURTHERAPY P. 408



SOFFIONI
SHOWER HEADS P. 422



PANNELLI DOCCIA
SHOWER PANELS P. 440



COLONNE DOCCIA
SHOWER COLUMN P. 444



SALISCENDI
SLIDING RAILS P. 468



DOCCETTE
HAND SHOWERS P. 476



OASIS SHUT-OFF P. 484



BOCCE - SPOUTS P. 496



ACCESSORI
COMPLEMENTS P.502

COMPLEMENTI
ED ACCESSORI
COMPLEMENTS
& ACCESSORIES



TOKYO STEEL P. 522



VOGUE P. 524



PARIS P. 526



WIRE P. 528



NEW YORK CITY P. 530



HILTON P. 532



REVIVAL P. 534



ACCESSORI BAGNO
BATH ACCESSORIES P. 536



IDROSCOPINI
HYDRO BRUSH P. 540

FINITURE FINISHINGS

CR



romo
chrome

CR

FIN 1



bianco lucido
shiny white

01



nero lucido
shiny black

07

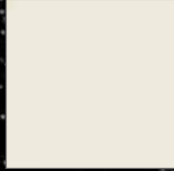

bianco raal
white raal

11

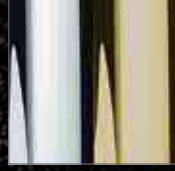

romo/oro
chrome/gold

CRDO



bianco raal/
romo
white raal/chrome

11CR



bianco raal/
oro
white raal/gold

11DO



nero lucido/
oro
shiny black/gold

07DO



nero lucido/
romo
shiny black/chrome

07CR



bianco raal/
ottone
white raal/brass

11OT

FIN 4

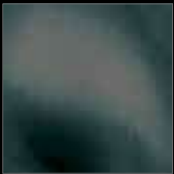

grafite
graphite

GO



romo nero lucido
shiny black chrome

CF



romo nero
spazzolato lucido
shiny brushed black
chrome

FZ



oro lucido
shiny gold

DO



oro anticato
old gold

88

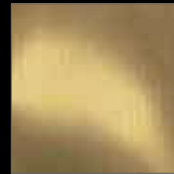

oro spazzolato
brushed gold

DP



oro inglese
english gold

EG



rame lucido
shiny copper

RL

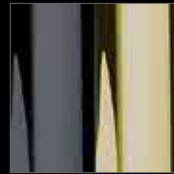

romo nero
lucido/
oro lucido
shiny black chrome/
shiny gold

CFDO

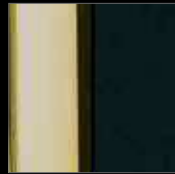

oro lucido/
bianco opaco
shiny gold/matt white

D015

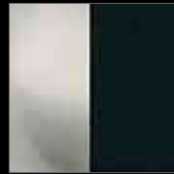

nicel
spazzolato
opaco/nero opaco
matt brushed nickel/
matt black

NP015



romo nero
lucido/
oro rosa spazzolato
shiny black chrome/
brushed pink gold

CFPP



bianco opaco/
oro lucido
matt white/shiny gold

14DO



nero lucido/
oro rosa lucido
shiny black/ shiny pink
gold

07PG

FIN 2



ottone lucido
shiny brass **OT**



ottone spazzolato
brushed brass **OP**



oil bronze
oil bronze **OIL**



vecchio ottone
old brass **63**

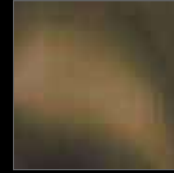

ottone s. marco
s. marco brass **SM**

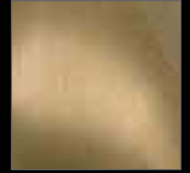

v. ottone opaco
matt old brass **OM**



nero opaco
matt black **15**



cromo spazzolato
brushed chrome **CP**



nicel spazzolato
brushed nickel **NP**



nicel spazzolato
opaco
matt brushed nickel **NPO**



vecchio rame
old copper **64**



bianco opaco
matt white **14**



nero opaco/
cromo
matt black/chrome **15CR**



nicel
spazzolato/
cromo
brushed nickel/chrome **NPCR**

FIN 5

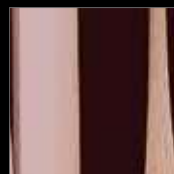

oro rosa lucido
shiny pink gold **PG**

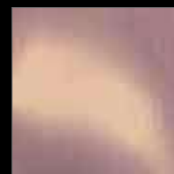

oro rosa spazzolato
brushed pink gold **PP**



rame anodizzato
anodised copper **RPO**

FIN 2

FINISHINGS



SKYLINE



FIN 4



FIN 5



SKYLINE



TOKYO



oro lucido
shiny gold 

TOKYO



rame lucido
shiny copper **RL**

FUSION



chrome nero spazzolato lucido
shiny brushed black chrome



FUSION



 rame anodizzato
anodised copper **RPO**



DEKORA DESIGN



MADE IN ITALY



I prodotti DANIEL hanno la caratteristica di poter essere personalizzati e ulteriormente impreziositi attraverso diverse finiture e decorazioni.

DANIEL RUBINETTERIE propone finiture galvaniche, antiche, spazzolate, oltre ai verniciati classici e molte altre tonalità possibili per rendere ogni prodotto assolutamente unico.

La tecnica brevettata DEKORA permette inoltre di personalizzare il prodotto abbinando la finitura di base a esclusivi temi decorativi.

Il Cliente può così scegliere tipologia e tonalità di preferenza per la finitura di base e combinarle con dedicati decori a contrasto.

I motivi decorativi suggeriti per ogni serie sono frutto di un continuo studio progettuale su forme, design e nuove tendenze.

DANIEL products have the peculiarity to be customized and further enriched through the various finishing and decorations. DANIEL RUBINETTERIE suggests galvanic finishing, antique, brushed, in addition to the painted classics and much more possible nuances to make each product a unique one.

The patented DEKORA technique also allows to customize faucet coordinating various finishes with exclusive decoration themes.

User can choose the preferred tone and type of the base finishing and combine them with delicate and innovative decoration motives.

The decoration styles suggested for every series are always the result from a keen study on shape, design and new tendencies.



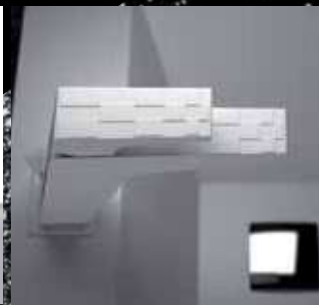

DEKORA SENSE DESIGN

Un nuovo stile decorativo proposto dalla fantasia creativa di Daniel Rubinetterie.

DEKORA SENSE è una finitura a rilievo per un risultato finale estremamente elegante, moderno e delicato: la decorazione acquista spessore e diventa parte viva del design del miscelatore, fondendosi in esso.

L'effetto a rilievo è plasmato nella forma e ben visibile; esso stupisce per innovazione e per la delicatezza con cui si presenta. Disponibile in diverse colorazioni, questa tecnica viene principalmente proposta nelle versioni bianco opaco e nero opaco. Dekora SENSE concretizza innovazione ed eleganza per donare carattere agli ambienti e affermare l'unicità dei progetti.

Un piccolo gioiello nel vostro bagno.

A new decorative style proposed by the creative fantasy of Daniel Rubinetterie.

DEKORA SENSE is a low-relief finish and its resulting effect is elegant, modern and soft: an embedded decoration that enhances the design of the tap accentuating the depth and melting into it.

The relief effect is shape moulded and well visible, surprising for its innovation and delicacy.

Customizable with different tones, this technique is mostly presented in matt white and matt black versions.

DEKORA SENSE materializes innovation and elegance to characterize the bathroom settings and to affirm the user uniqueness.

A small jewel in your bathroom.



MADE IN ITALY

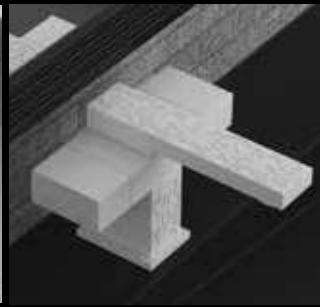

FINITURE FINISHING DEKORA

DECO 6	DECO 6	DECO 1	DECO 1	DECO 5	DECO 5	DECO 2	DECO 4	DECO 2	DECO 4	DECO 5	DECO 3
14	15	80	81	82	83	84	85	86	87	88	89
SENSE BIANCO OPACO	SENSE NERO OPACO	CROMO LUCIDO, NICHEL SPAZZOLATO	CROMO LUCIDO, ORO SPAZZOLATO	ORO LUCIDO, ORO SPAZZOLATO	ORO LUCIDO, NICHEL SPAZZOLATO	NICHEL SPAZZOLATO, CROMO LUCIDO	NICHEL SPAZZOLATO, ORO SPAZZOLATO	NICHEL SPAZZOLATO, CANNNA DI FUCILE SPAZZOLATO	NICHEL SPAZZOLATO, ORO LUCIDO	ORO ANTICO, CANNNA DI FUCILE SPAZZOLATO	OTTONE SCURITO, OTTONE LUCIDO
SENSE MATT WHITE	SENSE MATT BLACK	SHINY CHROME, BRUSHED NICKEL	SHINY CHROME, BRUSHED GOLD	SHINY GOLD, BRUSHED GOLD	SHINY GOLD, BRUSHED NICKEL	BRUSHED NICKEL, SHINY CHROME	BRUSHED NICKEL, BRUSHED GOLD	BRUSHED NICKEL, BRUSHED GUN BARREL	BRUSHED NICKEL, SHINY GOLD	ANTIQUÉ GOLD, BRUSHED GUN BARREL	DARK BRASS, SHINY BRASS

Serie OXY - OXY LIGH - OXY THERMO - CUBE WATERFALL

POP ART YL



DECO 1		DECO 2			DECO 4		DECO 5					DECO 6	
YL80	YL81	YL84	YL86	YL97	YL85	YL95	YL98	YL82	YL83	YL88	YL96	YL14	YL15

Serie TWIN

FANTASY YG



DECO 1	DECO 2			DECO 4			DECO 5				DECO 6	
YG81	YG84	YG86	YG97	YG87	YG95	YG98	YG82	YG83	YG88	YG96	YG14	YG15

Serie MISS - LIFE

DAMASCO YF



DECO 2		DECO 3	DECO 4			DECO 6			
YF86	YF97	YF89	YF87	YF95	YF98	YF83	YF88	YF94	YF96

Serie REVIVAL - SUVI - SUVI THERMO

SPIRAL YC



DECO 2		DECO 3				DECO 4			DECO 5		DECO 6	
YC86	YC97	YC90	YC91	YC92	YC93	YC85	YC95	YC98	YC88	YC96	YC14	YC15

DECO 3	DECO 3	DECO 3	DECO 3	DECO 5	DECO 4	DECO 5	DECO 2	DECO 4	DECO 5	DECO 5	DECO 4	DECO 2	DECO 5	DECO 4
90	91	92	93	94	95	96	97	98	99	1A	2A	3A	4A	5A
VECCHIO OTTONE, ORO LUCIDO	VECCHIO OTTONE, OTTONE SCURO	VECCHIO RAME, RAME LUCIDO	VECCHIO RAME, RAME SCURO	CANNA DI FUCILE, ORO SPAZZOLATO	CANNA DI FUCILE SPAZZOLATO, CROMO	ORO SPAZZOLATO, CROMO	NICHEL SPAZZOLATO, NICHEL LUCIDO	OTTONE SPAZZOLATO, OTTONE LUCIDO	ORO SPAZZOLATO, NICHEL SPAZZOLATO	CANNA DI FUCILE LUCIDO, ORO LUCIDO	CANNA DI FUCILE SPAZZOLATO, NICHEL SPAZZOLATO	NICHEL SPAZZOLATO, CANNA DI FUCILE LUCIDO	ORO SPAZZOLATO, CANNA DI FUCILE LUCIDO	CANNA DI FUCILE, CANNA DI FUCILE LUCIDO
OLD BRASS, SHINY GOLD	OLD BRASS, DARK BRASS	OLD COPPER, SHINY COPPER	OLD COPPER, DARK COPPER	GUN BARREL, BRUSHED GOLD	BRUSHED GUN BARREL, CHROME	BRUSHED GOLD, CHROME	BRUSHED NICKEL, SHINY NICKEL	BRUSHED BRASS, SHINY BRASS	BRUSHED GOLD, BRUSHED NICKEL	SHINY GUN BARREL, SHINY GOLD	BRUSHED GUN BARREL, BRUSHED NICKEL	BRUSHED NICKEL, SHINY GUN BARREL	BRUSHED GOLD, SHINY GUN BARREL	GUN BARREL, SHINY GUN BARREL

Serie SKYLINE - SKYLINE AMBIENT - SKYLINE THERMO



DECO 1	DECO 2			DECO 4			DECO 5				DECO 6	
YP81	YP84	YP86	YP97	YP85	YP95	YP98	YP82	YP83	YP88	YP96	YP14	YP15

Serie DIVA



DECO 1	DECO 2			DECO 4			DECO 5				DECO 6	
YM81	YM84	YM86	YM97	YM85	YM95	YM98	YM82	YM83	YM88	YM96	YM14	YM15

Serie SPEED



DECO 1	DECO 2				DECO 4				DECO 5			DECO 6	
YR80	YR84	YR86	YR97	YR3A	YR85	YR95	YR2A	YR5A	YR99	YR1A	YR4A	YR14	YR15
YE80	YE84	YE86	YE97	YE3A	YE85	YE95	YE2A	YE5A	YE99	YE1A	YE4A	YE14	YE15

RUBINETTERIA CREATIVA DAL 1985

CREATIVE TAPS SINCE 1985

Nata nel 1985, Daniel Rubinetterie è un'azienda produttrice di rubinetteria creativa.

Daniel Rubinetterie, sinonimo di ricercatezza e alta tecnologia produttiva, si impegna a diffondere e a confermare il valore della qualità "Made in Italy" in Italia e nel mondo.

Dai suoi stabilimenti in provincia di Milano, Daniel ha rivoluzionato l'approccio classico alla rubinetteria, ideando tecniche decorative brevettate e puntando sull'originalità delle creazioni.

L'obiettivo di Daniel è offrire un prodotto estremamente personalizzabile, che possa adattarsi alle specifiche esigenze del Cliente e farsi pura espressione del gusto personale.

La rubinetteria assume così un incarico esclusivo nel progetto di arredo, certa di soddisfare pienamente i gusti e le richieste di una Clientela sempre attenta alla qualità del prodotto e con un forte desiderio di differenziarsi.

Chi sceglie Daniel Rubinetterie è un consumatore esigente che cerca soluzioni innovative e richiede elevati standard qualitativi per un duraturo funzionamento nel tempo.

Da oltre 30 anni Daniel Rubinetterie soddisfa questo mercato fornendo un attento servizio di consulenza, scegliendo con grande cura i migliori materiali, utilizzando le tecniche di produzione e montaggio più moderne ed eseguendo dei minuziosi collaudi sui prodotti.

Born in 1985, Daniel Rubinetterie is a manufacturer of creative faucets. Daniel Rubinetterie, synonymous with elegance and high technology production, commits itself to develop and confirm the value of 'Made in Italy' quality in Italy and worldwide.

From its factories in Milan province, Daniel has revolutionized the classic approach to faucets, designing patented and decorative techniques and focusing on original creations.

Daniel's goal is to offer a highly customizable product, adaptable to Customers specific requirements and pure expression of personal taste.

The faucets thus take an exclusive assignment in the furniture project, sure to fully satisfy the tastes and demands of Clients increasingly attentive to the quality of the product and with a strong desire to stand out.

Who chooses Daniel Rubinetterie are demanding Customers looking for innovative solutions and requiring high quality standards for a durable operation over time.

Since more than 30 years Daniel Rubinetterie meets this market by providing an accurate consulting service, carefully choosing the best materials, using the most modern production and assembly processes and carrying out meticulous tests on the products.

L'AZIENDA THE COMPANY

REALIZZARE CREATE

IDEARE DESIGNING

Pulitura, Controllo qualità, Pre-assemblaggio,
Stampaggio plastico, Logistica.
*Polishing department, Test department,
Pre-assembly department, Injection plastic pressing
department, Logistic department.*

Sede operativa e uffici
amministrativi
Head office and factory.

ENGINEERING 2
produzione high-tech
high-tech production.

ENGINEERING 1
produzione high-tech
high-tech production.

produzione flessibili
flexible hoses production.



Cassano d'Adda (MI) - Italy
Lat: 45° 31' 37" N Long: 9° 30' 11" E

DANIEL
RUBINETTERIE
MILANO



PERSONALIZZARE
CUSTOMAZING

INNOVARE
INNOVATE

RISPETTARE
RESPECTING

REALIZZARE CREATE

Gli stabilimenti produttivi di Daniel Rubinetterie si trovano a Cassano D'Adda in provincia di Milano (Italia).
Un parco macchine di ultima generazione permette di eseguire con estrema precisione tutte le fasi di lavorazione che portano dalla creazione del prototipo alla realizzazione del prodotto finito, testato e confezionato.
Grazie alla meticolosità dei singoli passaggi possiamo dedicare grande attenzione anche ai più piccoli dettagli, arrivando ad un prodotto finito di alta qualità.

*Daniel Rubinetterie production plants are located in Cassano d'Adda, Milan province (Italy).
A fleet of the latest generation machinery allows to execute with extreme precision all the processing phases that lead from the creation of prototypes to the finished product, tested and packaged.
Thanks to the precision and internalization of the individual steps, we can pay great attention even to the smallest details, resulting in a high quality finished product.*



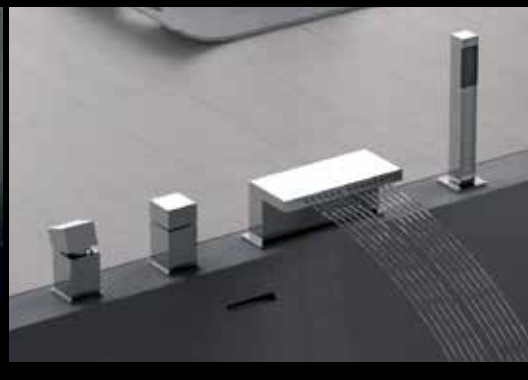
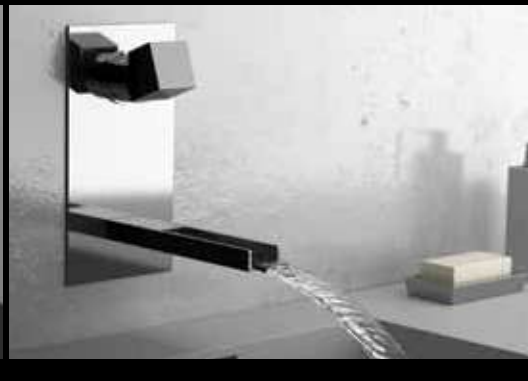

L'AZIENDA
THE COMPANY

REALIZZARE
CREATE

IDEARE
DESIGNING



IDEARE DESIGNING

Nell'intera offerta di Daniel, la rubinetteria viene concepita come un importante oggetto di arredo capace di assumere carattere e di sottolineare l'unicità di ogni ambiente.

I prodotti nascono all'interno del nostro Dipartimento di Design che progetta le collezioni seguendo ispirazioni creative in continua evoluzione e curando i dettagli estetici con la massima precisione.

Il Dipartimento interno di Ricerca e Sviluppo si occupa di completare il progetto, valutando le combinazioni di materiali e tecnologie più affini, definendo la soluzione migliore in termini di estetica e funzionalità.

Il risultato è una ricca gamma prodotti, caratterizzata da un design esclusivo e capace di accontentare le differenti esigenze di stile delle ambientazioni sia moderne che tradizionali.

Un intero catalogo di soluzioni studiate per dare forma ai desideri e renderli duraturi nel tempo.

Within the whole Daniel offer, faucets are conceived as an important furniture element, able to get character and emphasize the uniqueness of each environment.

The products have birth within our Design Department that conceives the collections following ever evolving creative inspirations and taking care of the aesthetic details with the maximum accuracy.

The internal Research and Development Department is responsible for completing the project, evaluating the combinations of materials and related technologies, defining the best solution in terms of aesthetics and functionality.

The result is a wide range of products, characterised by an exclusive design and able to satisfy the different environmental styles needs, both modern and traditional.

A whole catalogue of solutions designed to give shape to desires and make them lasting.



PERSONALIZZARE
CUSTOMAZING

INNOVARE
INNOVATE

RISPETTARE
RESPECTING

PERSONALIZZARE CUSTOMIZING

Permettere ai propri di Clienti di personalizzare con stile e creatività gli ambienti di bagno e cucina è la principale missione di Daniel Rubinetterie. Ogni Collezione viene corredata a catalogo da un'ampia scelta di finiture e decori che offrono innumerevoli possibilità di combinazione.

Le tecniche decorative brevettate **DEKORA** e **DEKORA SENSE** aprono inoltre un nuovo mondo di possibilità esclusive e aggiungono un prezioso potenziale creativo agli articoli Daniel.

Tutte le finiture sono eseguite su specifica richiesta e possono essere commissionate anche su un solo articolo.

In questo modo il Cliente è pienamente libero di esprimere la propria individualità, rendendo unico e prestigioso ogni progetto di arredo.

Give to its customers the chance to customize the bathroom and kitchen environments with style and creativity is the main mission of Daniel Rubinetterie. Each collection in catalog is accompanied by a wide choice of finishes and decors that offer numerous combination possibilities.

*Decorative patented techniques **DEKORA** and **DEKORA SENSE** open up a whole new world of further possibilities and add a valuable creative potential to Daniel items.*

All finishes are carried out on specific request and can even be commissioned on a single article.

In this way Customers are fully free to express their individuality, making each furnishing project unique and prestigious

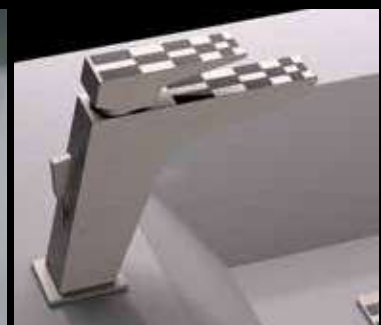

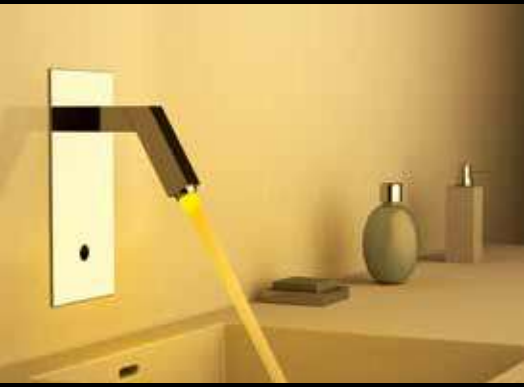

L'AZIENDA
THE COMPANY

REALIZZARE
CREATE

IDEARE
DESIGNING

INNOVARE INNOVATE

Daniel Rubinetterie è un'azienda dinamica, alla continua ricerca di soluzioni innovative e all'avanguardia. Grazie alla collaborazione con l'azienda italiana S.T.S.R., Daniel ha inserito nella sua offerta numerose proposte di rubinetteria con tecnologia integrata: luce LED, luce ambientale, sensori e temporizzatori ad alta precisione, tecnologia TOUCH-ME. Collezioni in continua evoluzione per arricchire la rubinetteria di nuove funzioni, combinando un design impeccabile con le comodità più moderne.

Daniel Rubinetterie is a dynamic company, always looking for innovative, avant-garde solutions. Thanks to the collaboration with the Italian company S.T.S.R., Daniel has included in its offer a wide range of taps with integrated LED light technology, ambient light, high precision sensors temporized faucets and TOUCH-ME technology. Ever evolving collections in order to enrich faucets with new functions by combining impeccable design with modern comforts.





PERSONALIZZARE
CUSTOMAZING

INNOVARE
INNOVATE

RISPETTARE
RESPECTING

RISPETTARE RESPECTING

Daniel Rubinetterie produce dove vive e lo fa nel pieno rispetto dell'ambiente.

L'azienda è certificata sia a livello nazionale (UNI) che europeo dall'ente tedesco TÜV Thüringen secondo gli standard ISO 9001, sistema di qualità aziendale, e ISO 14001, sistema di qualità ambientale.

La produzione interna agli stabilimenti del Gruppo permette inoltre di pianificare e seguire con attenzione ogni passaggio del ciclo produttivo, ottimizzando le risorse, limitando gli sprechi e garantendo la massima efficienza.

Sempre seguendo la direzione di un ridotto impatto ambientale, nel catalogo Daniel sono presenti molteplici soluzioni per facilitare il risparmio idrico negli ambienti pubblici e privati.

Ne sono d'esempio le collezioni di rubinetteria TOUCH-ME a sensore e temporizzata che riducono l'utilizzo dell'acqua alla sola effettiva necessità e le proposte di miscelazione termostatica che limitano il consumo energetico e le dispersioni di acqua non utilizzata.

Daniel Rubinetterie produces where it lives, fully respecting the environment.

The company is certified at both national (UNI) and European level by the German body TÜV Thüringen according to standards ISO 9001, quality management system, and ISO 14001, environmental quality system.

Domestic production within the Group factories also allows to schedule and carefully follow each step of the production cycle, optimizing resources, reducing waste and ensuring maximum efficiency.

Always aiming a reduced environmental impact, in Daniel catalog there are many solutions to help water saving both in public and private environments.

TOUCH-ME temporized and sensor faucets collections are examples of this, reducing water usage only to the effective need, as well as the thermostatic mixing proposals limiting energy consumption and not used water losses.



ANIMA E DESIGN
SOUL & DESIGN

CONTEMPORANEO
CONTEMPORARY

CASCATA E COLORE
WATERFALL & COLOUR



DANIEL
RUBINETTERIE
MILANO

COLLECTION 2019

CLASSICA
CLASSIC

LIVING

TERMOSTATICI
THERMOSTATICS



FUSION

Le linee di FUSION appaiono come plasmate dagli elementi della natura e tutta la serie sprigiona sensazioni di armonia sia alla vista che al tatto. La basetta diventa parte stessa del corpo miscelatore creando una figura unica e scultorea. L'aeratore a scomparsa esalta la linea del prodotto donandogli ulteriore eleganza.

FUSION lines appear as shaped by the elements of nature and the whole series emanates feelings of harmony both to the eye and to the touch. The base becomes part of the mixer body creating a unique and sculptural shape. The hidden aerator enhances the product lines by giving it further elegance.

FINISHINGS

 CP cromo spazzolato brushed chrome	 NP nichel spazzolato brushed nickel	 NPO nichel spazzolato opaco matt brushed nickel	 63 vecchio ottone old brass	 OIL oil bronze oil bronze
 64 vecchio rame old copper	 14 bianco opaco matt white	 15 nero opaco matt black		
FIN 2				
 DO oro lucido shiny gold	 DP oro spazzolato brushed gold	 FZ cromo nero spazzolato lucido shiny brushed black chrome	 CF cromo nero lucido shiny black chrome	 RL rame lucido shiny copper
 GO grafite graphite				
FIN 4				
 PG oro rosa lucido shiny pink gold	 PP oro rosa spazzolato brushed pink gold	 RPO rame anodizzato anodised copper		

BICOLOUR

 D015 oro lucido/nero opaco shiny gold/matt black	 NP015 nichel spazzolato opaco/nero opaco matt brushed nickel/matt black	 CFPP cromo nero lucido/oro rosa spazzolato shiny black chrome/brushed pink gold
 14DO bianco opaco/ oro lucido matt white/shiny gold	 07PG nero lucido/oro rosa lucido shiny black/ shiny pink gold	

Finiture consigliate per questa collezione.
Per l'elenco completo fare riferimento alla tabella delle finiture (pag.04)

*Suggested finishes for this collection.
For a complete list of available colors, please refer to the finishing table (page 04)*



FUSION

TOKYO

TOKYO
STEEL

DIVA
DEKORA
SENSE

SPEED
DEKORA
SENSE

TIARA

SKYLINE

DEKORA
SENSE

SUVI
DEKORA
SENSE

OXY
DEKORA
SENSE

JAX

KIR

TWIN
DEKORA
SENSE



FUSION

CARATTERISTICHE TECNICHE:

La serie è dotata di cartuccia a dischi ceramici, Ø 35 mm, prodotta da S.T.S.R. – Studio Tecnico Sviluppo e Ricerche - www.stsr.it

TECHNICAL CHARACTERISTICS:

The series is equipped with ceramic cartridge, Ø 35 mm, produced by S.T.S.R. - Research Development Technical Office - www.stsr.it

LAVABI - WASHBASIN MIXERS



Monocomando lavabo
Altezza: 19,8 cm - Interasse: 12 cm
Single-lever basin mixer.
Height: 19,8 cm - Interaxis: 12 cm.

FU605

Con scarico.
With pop-up waste.

FU606

Senza scarico.
Without waste.

FU606N

Senza scarico e senza foro sul corpo.
Without waste and without body hole.



Monocomando lavabo alto.
Altezza: 33,7 cm - Interasse: 18,5 cm.
High single-lever basin mixer.
Height: 33,7 cm - Interaxis: 18,5 cm.

FU607

Con scarico click-clack.
With click-clack waste.

FU607B

Senza scarico.
Without waste.



FU632

Miscelatore monocomando a incasso per lavabo, con piastra orizzontale in ottone cromato. Lunghezza bocca: 19 cm.
Single-lever built-in basin mixer, with horizontal wall flange in chrome plated brass.
Length spout: 19 cm.



FU655

Miscelatore monocomando lavabo due fori.
Altezza: 23,2 cm - Interasse: 17,2 cm
Two holes single-lever washbasin mixer.
Height: 23,2 cm - Interaxis: 17,2 cm.

LAVABO BOX INCASSO - BUILT-IN BOX WASHBASIN MIXER



+



FU632KB

Miscelatore monocomando a incasso per lavabo, con piastra in ottone cromato, bocca lunghezza 19 cm, da abbinare al box incasso.

Single-lever built-in basin mixer, with wall flange in chrome plated brass, spout length 19 cm, to match with the built-in box.

DAN BOX632

Box da incasso per miscelatore monocomando a incasso per lavabo.
Built-in box for single-lever built-in basin mixer.

FUSION

TOKYO

TOKYO
STEEL

DIVA
DEKORA
SENSE

BIDET

SPEED
DEKORA
SENSE

TIARA

SKYLINE
DEKORA
SENSE

SUVI
DEKORA
SENSE

OXY
DEKORA
SENSE

JAX

KIR

TWIN
DEKORA
SENSE



Monocomando bidet.
Altezza: 17,4 cm - Interasse: 12,1 cm.
*Single-lever bidet mixer.
Height: 17,4 cm - Interaxis: 12,1 cm.*

FU604

Con scarico.
With pop-up waste.

FU604B

Senza scarico.
Without waste.



FU6424DC

Miscelatore incasso per shut-off con doccetta shut-off, supporto doccia e presa acqua.
Built-in shut-off mixer set, with handshower shut-off, shower holder and water punch.



Miscelatore incasso per shut-off.
Built-in shut-off mixer set.

FU6454DC

Con doccetta shut-off, supporto doccia e presa acqua.
With shut-off, shower holder and water punch.

FU645H

Senza kit doccia.
Without shower set.

INCASSI DOCCIA E BOCCHE - BUILT-IN MIXERS & SPOUTS



FU602
Miscelatore doccia incasso.
Built-in shower mixer.



FU612
Miscelatore doccia incasso con deviatore.
Built-in bath/shower mixer with diverter.

IN602C35 Parte interna miscelatore monocomando incasso doccia.
Single-lever shower mixer (built-in components).

IN612C35 Parte interna miscelatore monocomando incasso vasca/doccia con deviatore.
Single-lever bath/shower mixer with diverter (built-in components).

FU602EKIT Parte esterna miscelatore monocomando incasso doccia.
Single-lever shower mixer (external components).

FU612EKIT Parte esterna miscelatore monocomando incasso vasca/doccia con deviatore.
Single-lever bath/shower mixer with diverter (external components).



FU612D2
Miscelatore monocomando per doccia con deviatore a 2 posizioni su piastra unica.
Single-lever shower mixer, with 2 positions diverter on single flange.



FU612D3
Miscelatore monocomando per doccia con deviatore a 3 vie e 3 posizioni (una entrata e tre uscite) su unica piastra.
Single lever built-in shower mixer with 3 ways diverter and 3 positions (1 inlet and 3 outlets) on single flange.



FU612D7
Miscelatore monocomando per doccia con deviatore a tre 3 e 7 posizioni su unica piastra.
Single lever built-in shower mixer with 3 ways diverter and 7 positions on single flange.



FU4704
Bocca incasso.
Lunghezza bocca: 19 cm.
*Built-in spout.
Spout Length: 19 cm.*

BOX INCASSO - BUILT-IN BOX

FU602KB

Set miscelatore doccia da abbinare al box incasso.
Shower mixer set to match with the built-in box.



DAN BOX

Box da incasso per miscelatore doccia con deviatore.
Built-in box for shower mixer with diverter.

FU612KB

Set miscelatore doccia con deviatore da abbinare al box incasso.
Shower mixer set with diverter to match with the built-in box.



DAN BOX

Box da incasso per miscelatore doccia con deviatore.
Built-in box for shower mixer with diverter.

FU612D2KB

Set miscelatore doccia due vie da abbinare al box incasso.
Two ways shower mixer set to match with the built-in box.



DAN BOXD2

Box da incasso per miscelatore doccia due vie.
Built-in box for two ways shower mixer.

FU612D3KB

Set miscelatore doccia tre vie da abbinare al box incasso.
Three ways shower mixer set to match with the built-in box.



DAN BOXD3

Box da incasso per miscelatore doccia tre vie.
Built-in box for three ways shower mixer.

FU612D7KB

Set miscelatore doccia tre vie e sette posizioni da abbinare al box incasso.
Three ways and seven positions shower mixer set to match with the built-in box.



DAN BOXD3

Box da incasso per miscelatore doccia tre vie.
Built-in box for three ways shower mixer.

FUSION

TOKYO

TOKYO
STEEL

DIVA
DEKORA
SENSE

SPEED
DEKORA
SENSE

TIARA

SKYLINE
DEKORA
SENSE

SUVI
DEKORA
SENSE

OXY
DEKORA
SENSE

JAX

KIR

TWIN
DEKORA
SENSE

MISCELATORI VASCA E DOCCIA - SHOWER AND BATH MIXERS



Miscelatore vasca esterno.
Exposed bath mixer.

FU610

Con kit doccia e flessibile da 150 cm.
With shower kit and 150 cm flexible.

FU600H

Senza kit doccia
Without shower kit.



Miscelatore doccia esterno.
Exposed shower mixer.

FU631A

Con kit doccia e flessibile da 150 cm.
With shower kit and 150 cm flexible.

FU631

Senza kit doccia
Without shower kit.



Miscelatore vasca/doccia.
Bath/shower mixer.

FU600DH

Con attacco superiore da 1/2" ed attacco inferiore da 1/2".
With upper 1/2" connection and lower connection 1/2".

FU600DH34

Con attacco superiore da 3/4" ed attacco inferiore da 1/2".
With upper 3/4" connection and lower connection 1/2".



FU631Z

Miscelatore doccia esterno con attacco superiore da 3/4".
Exposed shower mixer with 3/4" upper connection.



A388 477

Saliscendi cromato con asta minimale ovale dritta, doccetta cromata a 4 funzioni, pulsante per cambio getti, anticalcare e flessibile conico in ottone cromato cm 150 Art. A505X150.
Altezza: 65 cm.
C.p. sliding rail set with c.p. handshower 4 functions, with button to change the jets, anti-limestone and conical shower flexible in c.p. brass cm 150 Art. A505X150.
Height: 65 cm.

COLONNE DOCCIA - SHOWER COLUMNS

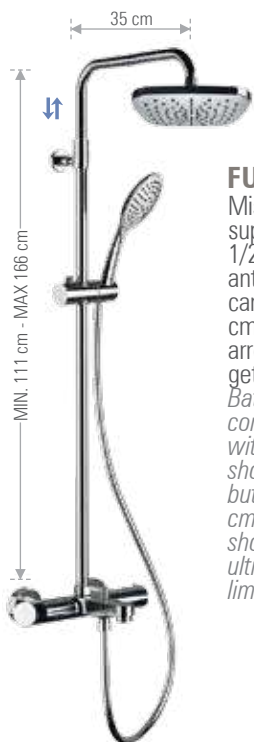

FU636DAAD20

Miscelatore vasca/doccia con attacco superiore da 3/4" ed attacco inferiore da 1/2", colonna doccia telescopica con deviatore, doccetta anticalcare a 4 funzioni e pulsante per il cambio dei getti, con flessibile A505X 150 cm e soffione a pioggia, quadrato con angoli arrotondati in ABS cromato, 20x20 cm, con getti in silicone anticalcare.

Bath/shower mixer with upper 3/4" connection and lower connection 1/2", with telescopic shower column, c.p. hand shower 4 functions antilimestone with button to change jets, with A505X 150 cm flexible hose and chrome plated ABS showerhead, squared with rounded edges, ultraflat, rain jet, 20x20 cm, with antilimestone silicon jets.

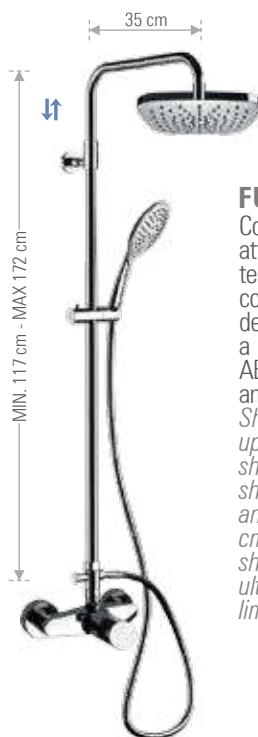

FU636AAD20

Colonna doccia con miscelatore doccia e attacco superiore da 3/4", colonna doccia telescopica con deviatore, doccetta a 4 funzioni con getti anticalcare e pulsante per il cambio dei getti, con flessibile A505 150 cm e soffione a pioggia, quadrato con angoli arrotondati in ABS cromato, 20x20 cm, con getti in silicone anticalcare.

Shower column with shower mixer and upper connection 3/4", with telescopic shower column with diverter, c.p. hand shower 4 functions with antilimestone jets and button to change jets, with A505 150 cm flexible hose and chrome plated ABS showerhead, squared with rounded edges, ultraflat, rain jet, 20x20 cm, with antilimestone silicon jets.

FUSION

TOKYO

TOKYO
STEEL

DIVA
DEKORA
SENSE

SPEED
DEKORA
SENSE

TIARA

KIT WELLNESS - WELLNESS KIT

SKYLINE

DEKORA
SENSE

SUVI

DEKORA
SENSE

OXY

DEKORA
SENSE

JAX

KIR

TWIN

DEKORA
SENSE

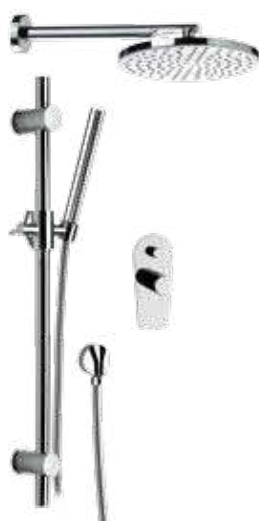

FU614Z0

Set doccia composto da:
Art. A552CM30 A594: soffione doccia Ø20 cm con getti anticalcare e braccio minimale 30 cm tutto in ottone cromato.

Art. FU612: Monocomando vasca/doccia incasso con deviatore.

Art. A340 A435 A505 150: saliscendi con asta minimale, doccetta ad 1 funzione con flessibile conico 150 cm, tutto in ottone cromato.

Art. A525: presa acqua rotonda in ottone cromato.

*Shower set composed of:
Art. A552CM30 A594: chrome plated brass showerhead Ø20 cm, silicon selfcleaning antilimestone jets, with minimal arm in brass cm 30.*

Art. FU612: Built-in bath/shower mixer with diverter.

Art. A340 A435 A505 150: sliding rail set with 1 function handshower, conical shower flexiblehose 150 cm, all in c.p. brass.

Art. A525: luxury water punch round type in c.p. brass.



FU615Z0

Set doccia composto da:
Art. A552CM30 A594: soffione doccia Ø20 cm con getti anticalcare e braccio minimale 30 cm, tutto in ottone cromato.

Art. FU612: Monocomando vasca/doccia incasso con deviatore.

Art. A546 A435 A505 150: doccetta ad 1 funzione, presa acqua/supporto e flessibile conico 150 cm, tutto in ottone cromato.

*Shower set composed of:
Art. A552CM30 A594: showerhead Ø20 cm with silicon selfcleaning antilimestone jets, and minimal arm 30 cm, all in c.p. brass.*

Art. FU612: Built-in bath/shower mixer with diverter.

Art. A546 A435 A505 150: 1 function handshower, water punch/shower holder with shower flexible hose 150 cm, all in c.p. brass.

FUSION

FU614Z

Set doccia composto da:
 Art. A552CM30 A584AD20: soffione doccia cm 20x20 quadrato con angoli arrotondati ultrapiatto in ABS cromato, e getti anticalcare con braccio minimale in ottone cromato 30 cm.

Art. FU612: Monocomando vasca/doccia incasso con deviatore.

Art. A388 A477 A505X150: saliscendi cromato con asta minimale ovale dritta, doccetta cromata a 4 funzioni anticalcare con pulsante per cambio getti, flessibile conico in ottone cromato 150 cm.

Art. A525: presa acqua rotonda in ottone cromato.

Shower set composed of:

Art. A552CM30 A584AD20: Chrome plated ABS squared ultraflat showerhead with rounded edges, silicon selfcleaning antilimestone jets, with minimal arm in brass 30 cm.

Art. FU612: Built-in bath/shower mixer with diverter.

Art. A388 A477 A505X150: sliding rail set with c.p. ABS antilimestone handshower 4 functions with button to change the jets, conical shower flexible hose in c.p. brass 150 cm.

Art. A525: luxury water punch round type.



FU615Z

Set doccia composto da:
 Art. A552CM30 A584AD20: soffione doccia cm 20x20 quadrato con angoli arrotondati ultrapiatto in ABS cromato, e getti anticalcare con braccio minimale in ottone cromato 30 cm.

Art. FU612: Monocomando vasca/doccia incasso con deviatore.

Art. A546 A477 A505X150: doccetta in ABS cromato anticalcare a 4 funzioni con pulsante per cambio getti, presa acqua supporto in ottone cromato con flessibile conico in ottone cromato 150 cm.

Art. A552CM30 A584AD20: Chrome plated ABS squared ultraflat showerhead with rounded edges, silicon selfcleaning antilimestone jets, with minimal arm in brass 30 cm.

Art. FU612: Built-in bath/shower mixer with diverter.

Art. A546 A477 A505X150: c.p. ABS antilimestone handshower 4 functions with button to change the jets, water punch/shower holder in brass and flexible hose in brass 150 cm.



CUCINA - KITCHEN



FU618

Miscelatore monocomando monoforo 90°, con canna alta a "U".

Altezza: 33,5 cm - Interasse: 17,5 cm.

Single-lever sink mixer 90°, high "U" spout.

Height: 33,5 cm - Interaxis 17,5 cm.



FU618C

Miscelatore monocomando per lavello, con canna corta a "U", tipo lusso.

Altezza: 30 cm - Interasse: 12 cm.

Single-lever one-hole sink mixer, with short "U" spout, luxury type.

Height: 30 cm - Interaxis 12 cm.



FU614B

Miscelatore monocomando per lavello, con bocca alta girevole.

Altezza: 30 cm - Interasse: 17 cm.

Single-lever one-hole sink mixer, with high movable spout.

Height: 30 cm - Interaxis 17 cm.



FU614BC

Miscelatore monocomando per lavello, con canna corta girevole.

Altezza: 26 cm - Interasse: 12,5 cm.

Single-lever one-hole sink mixer, with short movable spout.

Height: 26 cm - Interaxis 12,5 cm.

ACQUA DEPURATA - PURIFIED WATER



FU679DW

Miscelatore lavello a tre vie di ingresso con bocca girevole e due vie d'uscita completamente indipendenti, con selezione acqua potabile tramite la leva.

Altezza: 35,7 cm - Interasse: 17,2 cm.

Three ways inlet single lever sink mixer, with movable spout and two fully independent outlets, with selection for drinking water directly from the lever.

Height: 35,7 cm - Interaxis 17,2 cm.



GOURMET

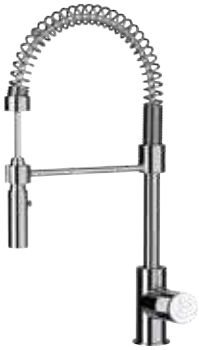

FUT689

Miscelatore monocomando lavello a molla con doccetta estraibile dal supporto ed orientabile a due funzioni e cartuccia Ø 35.
Altezza: 48 cm - Interasse: 21,5 cm.
Spring single-lever sink mixer with detachable and adjustable 2-functions hand shower and Ø 35 mm cartridge.
Height: 48 cm - Interaxis 21,5 cm.



FU233

Miscelatore lavello monocomando con flessibile nero rivestito con molla "fine design" girevole 360°, con doccetta estraibile dal supporto ed orientabile a due funzioni e cartuccia Ø 35.
Altezza: 40,7 cm - Interasse: 21 cm.
Single-lever mixer with black flexible hose coated with "fine design" spring, 360° movable, with detachable and adjustable 2-functions hand shower and Ø 35 mm cartridge.
Height: 40,7 cm - Interaxis 21 cm.



FUSION

TOKYO

TOKYO
STEEL

DIVA
DEKORA
SENSE

SPEED
DEKORA
SENSE

TIARA

SKYLINE
DEKORA
SENSE

SUVI
DEKORA
SENSE

OXY
DEKORA
SENSE

JAX

KIR

TWIN
DEKORA
SENSE

TOUCH-ME



FUT618

Miscelatore monocomando lavello, monoforo 90° con canna alta ad "U" dotata di tecnologia Touch-Me con leva laterale e bocca girevole. Dotato di cartuccia Ø35.
Altezza: 34 cm - Interasse: 17,5 cm.
Single-lever sink mixer 90°, high "U" spout equipped with Touch-Me system with side lever and movable spout. Equipped with Ø35 cartridge.
Height: 34 cm - Interaxis 17,5 cm.



FUT618C

Miscelatore monocomando lavello, monoforo 90° con canna corta ad "U" dotata di tecnologia Touch-Me con leva laterale e bocca girevole. Dotato di cartuccia Ø35.
Altezza: 31 cm - Interasse: 12 cm.
Single-lever sink mixer 90°, short "U" spout equipped with Touch-Me system with side lever and movable spout. Equipped with Ø35 cartridge.
Height: 31 cm - Interaxis 12 cm.



TOKYO CHROME

La serie TOKYO è la sintesi perfetta di un design che basa la sua natura sull'essenza del minimalismo. L'utilizzo della cartuccia Ø 25 mm rende i corpi miscelatore estremamente eleganti e slanciati. Le bocche di erogazione dalla morbida curvatura esaltano la linea accompagnando dolcemente l'acqua nel suo fluire. TOKYO è un miscelatore di classe dal design intramontabile.

The TOKYO Series is the perfect synthesis of a design that bases its nature on the essence of minimalism. The use of the Ø 25 mm cartridge makes the mixer bodies extremely elegant and willowy. The soft-bending spouts enhance the line by gently following the water in its flow. TOKYO is a timeless design classy mixer.

FINISHINGS

CP cromo spazzolato
brushed chrome

64 vecchio rame
old copper

DO oro lucido
shiny gold

GO grafite
graphite

PG oro rosa lucido
shiny pink gold

NP nichel spazzolato
brushed nickel

14 bianco opaco
matt white

DP oro spazzolato
brushed gold

PP oro rosa spazzolato
brushed pink gold

FIN 2

NPO nichel spazzolato opaco
matt brushed nickel

15 nero opaco
matt black

FZ cromo nero spazzolato lucido
shiny brushed black chrome

63 vecchio ottone
old brass

OIL oil bronze
oil bronze

FIN 4

CF cromo nero lucido
shiny black chrome

RL rame lucido
shiny copper

FIN 5

RPO rame anodizzato
anodised copper

Finiture consigliate per questa collezione.
Per l'elenco completo fare riferimento alla tabella delle finiture (pag.04)

*Suggested finishes for this collection.
For a complete list of available colors, please refer to the finishing table (page 04)*



ANIMA & DESIGN
SOUL & DESIGN

FUSION

TOKYO

TOKYO
STEEL

DIVA
DEKORA
SENSE

SPEED
DEKORA
SENSE

TIARA

SKYLINE
DEKORA
SENSE

SUVI
DEKORA
SENSE

OXY
DEKORA
SENSE

JAX

KIR

TWIN
DEKORA
SENSE



CARATTERISTICHE TECNICHE:

La serie è dotata di cartuccia a dischi ceramici Ø25 mm, vasca ed incassi doccia Ø35 mm prodotte da S.T.S.R. – Studio Tecnico Sviluppo e Ricerche - www.stsr.it

TECHNICAL CHARACTERISTICS:

The series is equipped with ceramic cartridge Ø25 mm, bath and shower mixers Ø35 mm, produced by S.T.S.R. - Research Development Technical Office - www.stsr.it



Disponibile con leva lunga sostituendo TX a TK.

Es. **TX605**

Also available with long lever replacing "TK" with "TX".

Ex. **TX605**

LAVABI - WASHBASIN MIXERS



Monocomando lavabo
Altezza: 17,9 cm - Interasse: 11 cm
Single-lever basin mixer.
Height: 17,9 cm - Interaxis: 11 cm.

TK605

Con scarico.
With pop-up waste.

TK606

Senza scarico.
Without waste.

TK606N

Senza scarico e senza foro sul corpo.
Without waste and without body hole.



Monocomando lavabo alto.
Altezza: 31,4 cm - Interasse: 16,5 cm
High basin mixer.
Height: 31,4 cm - Interaxis: 16,5 cm.

TK607

Con scarico click-clack.
With click-clack waste.

TK607B

Senza scarico.
Without waste.



TK655

Miscelatore monocomando lavabo due fori.
Altezza: 23,2 cm - Interasse: 17,2 cm
Two holes single-lever washbasin mixer.
Height: 23,2 cm - Interaxis: 17,2 cm.



TK632

Miscelatore monocomando a incasso per lavabo, con piastra orizzontale in ottone cromato.
Lunghezza bocca: 17 cm.
Single-lever built-it basin mixer, with horizontal wall flange in chrome plated brass.
Length spout: 17 cm.



TK632P

Miscelatore monocomando a incasso per lavabo, in ottone cromato.
Lunghezza bocca: 16 cm max.
Single-lever built-it basin mixer, in chrome plated brass.
Length spout: 16 cm max.



TK688

Miscelatore monocomando lavabo da pavimento con scarico click-clack e troppo pieno.
Altezza bocca: 92 cm - Interasse: 18 cm
Single-lever mixer floor mounting with click-clack waste and overflow.
Height spout: 92 cm - Interaxis: 18 cm.



LEVA TK
TK LEVER



LEVA TX
TX LEVER

FUSION

TOKYO

TOKYO
STEEL

DIVA
DEKORA
SENSE

SPEED
DEKORA
SENSE

TIARA

SKYLINE
DEKORA
SENSE

SUVI
DEKORA
SENSE

OXY
DEKORA
SENSE

JAX

KIR

TWIN
DEKORA
SENSE

LAVABO BOX INCASSO - BUILT-IN BOX WASHBASIN MIXER



TK632KB

Miscelatore monocomando a incasso per lavabo, con piastra in ottone cromato, bocca lunghezza 17 cm, da abbinare al box incasso.

Single-lever built-in basin mixer, with wall flange in chrome plated brass, spout length 17 cm, to match with the built-in box.

DAN BOX632

Box da incasso per miscelatore monocomando a incasso per lavabo.
Built-in box for single-lever built-in basin mixer.

BIDET



Monocomando bidet.
Altezza: 12,9 cm - Interasse: 9,5 cm
*Single-lever bidet mixer.
Height: 12,9 cm - Interaxis: 9,5 cm.*

TK604

Con scarico.
With pop-up waste.

TK604B

Senza scarico.
Without waste.





TK6424DC

Miscelatore incasso per shut-off con doccetta shut-off, supporto doccia e presa acqua.
Built-in shut-off mixer set with shut-off, shower holder and water punch.



Miscelatore incasso per shut-off.
Built-in shut-off mixer set.

TK6454DC Con doccetta shut-off, supporto doccia e presa acqua.
With shut-off, shower holder and water punch.

TK645H Senza kit doccia.
Without shower set.

MISCELATORI VASCA E DOCCIA - SHOWER AND BATH MIXERS



Miscelatore doccia esterno.
Exposed shower mixer.

TK611A Con kit doccia e flessibile da 150 cm.
With shower kit and 150 cm flexible.

TK611 Senza kit doccia
Without shower kit.



Miscelatore vasca esterno.
Exposed bath mixer.

TK610 Con kit doccia e flessibile da 150 cm.
With shower kit and 150 cm flexible.

TK600H Senza kit doccia
Without shower kit



TK678

Miscelatore vasca da pavimento con deviatore e kit doccia.
 Altezza bocca: 76 cm - Interasse: 18 cm
*Free standing bath mixer floor mounting with diverter and shower kit.
 Height spout: 76 cm - Interaxis: 18 cm.*



INCASSI DOCCIA E BOCCHE - BUILT-IN MIXERS & SPOUTS



TK612
Miscelatore doccia incasso con deviatore.
Built-in bath/shower mixer with diverter.



TK602
Miscelatore doccia incasso.
Built-in shower mixer.

IN612C35

Parte interna miscelatore monocomando incasso vasca/doccia con deviatore.
Single-lever bath/shower mixer with diverter (built-in components).

IN602C35

Parte interna miscelatore monocomando incasso doccia.
Single-lever shower mixer (built-in components).

TK612EKIT

Parte esterna miscelatore monocomando incasso vasca/doccia con deviatore.
Single-lever bath/shower mixer with diverter (external components).

TK602EKIT

Parte esterna miscelatore monocomando incasso doccia.
Single-lever shower mixer (external components).

FUSION

TOKYO

TOKYO
STEEL

DIVA
DEKORA
SENSE

SPEED
DEKORA
SENSE

TIARA

SKYLINE
DEKORA
SENSE

SUVI
DEKORA
SENSE

OXY
DEKORA
SENSE

JAX

KIR

TWIN
DEKORA
SENSE



TK612D2
Miscelatore monocomando per doccia con deviatore a 2 posizioni su piastra unica.
Single-lever shower mixer, with 2 positions diverter on single flange.



TK612D3
Miscelatore monocomando per doccia con deviatore a 3 vie e 3 posizioni (una entrata e tre uscite) su unica piastra.
Single lever built-in shower mixer with 3 ways diverter and 3 positions (1 inlet and 3 outlets) on single flange.



TK612D7
Miscelatore monocomando per doccia con deviatore a 3 vie e 7 posizioni su unica piastra.
Single lever built-in shower mixer with 3 ways diverter with 7 positions on single flange.



TK4704
Bocca incasso.
Lunghezza bocca: 16,5 cm.
*Built-in spout.
Lenght spout: 16,5 cm.*

BOX INCASSO - BUILT-IN BOX

TK602KB

Set miscelatore doccia da abbinare al box incasso.
Shower mixer set to match with the built-in box.



+



DAN BOX

Box da incasso per miscelatore doccia con deviatore.
Built-in box for shower mixer with diverter.

TK612KB

Set miscelatore doccia con deviatore da abbinare al box incasso.
Shower mixer set with diverter to match with the built-in box.



+



DAN BOX

Box da incasso per miscelatore doccia con deviatore.
Built-in box for shower mixer with diverter.

TK612D2KB

Set miscelatore doccia due vie da abbinare al box incasso.
Two ways shower mixer set to match with the built-in box.



+



DAN BOXD2

Box da incasso per miscelatore doccia due vie.
Built-in box for two ways shower mixer.

TK612D3KB

Set miscelatore doccia tre vie da abbinare al box incasso.
Three ways shower mixer set to match with the built-in box.



+



DAN BOXD3

Box da incasso per miscelatore doccia tre vie.
Built-in box for three ways shower mixer.

TK612D7KB

Set miscelatore doccia tre vie e sette posizioni da abbinare al box incasso.
Three ways and seven positions shower mixer set to match with the built-in box.



+



DAN BOXD3

Box da incasso per miscelatore doccia tre vie.
Built-in box for three ways shower mixer.

KIT WELLNESS - WELLNESS KIT

TK614Z0

Set doccia composto da:
 Art. A594 A552CM30: Soffione doccia Ø20 cm con getti anticalcare e braccio 30 cm tutto in ottone cromato.
 Art. A340 A435 con A505 150: saliscendi minimale con doccetta minimale e flessibile conico 150 cm, tutto in ottone cromato.
 Art. A525: presa acqua tipo rotondo pesante in ottone cromato.
 Art. TK612: Miscelatore incasso con deviatore e piastra lusso.
*Shower set composed by:
 Art A594 A552CM30: shower head Ø20 cm with antilimestone silicon jets, and arm 30 cm, all in c.p. brass.
 Art A340 A435 with A505X150: minimal sliding rail with minimal handshower and shower flexible hose 150 cm, all in c.p. brass.
 Art. A525: C.p. brass wall connector, round heavy type
 Art. TK612: Built-in mixer with diverter and deluxe flange.*



TK615Z0

Set doccia composto da:
 Art. A594 A552CM30: Soffione doccia in ottone cromato Ø20 cm con braccio in ottone 30 cm.
 Art. A546 A435 con A505 150: Doccia duplex Minimal completamente in ottone cromato con supporto presa acqua e flessibile conico in ottone cromato cm 150.
 Art. TK612: Miscelatore incasso con deviatore e piastra lusso.
*Shower set composed by:
 Art A594 A552CM30: c.p. brass shower head Ø20 cm with arm in c.p. brass 30 cm.
 Art. A546 A335 with A505 150: water punch/shower holder with Minimal handshower completely in c.p. brass and shower flexible hose in brass 150 cm.
 Art. TK612: Built-in mixer with diverter and deluxe flange.*



FUSION

TOKYO

TOKYO
STEEL

DIVA
DEKORA
SENSE

SPEED
DEKORA
SENSE

TIARA

SKYLINE
DEKORA
SENSE

SUVI
DEKORA
SENSE

OXY
DEKORA
SENSE

JAX

KIR

TWIN
DEKORA
SENSE



TK614Z

Set doccia composto da:
 Art. A578CM20 A552CM30: soffione doccia ultra piatto Ø20 cm in acciaio INOX lucidato a specchio con getti anticalcare e braccio in ottone cromato 30 cm.
 Art. A335 A435 con A505X150: saliscendi minimale con doccetta ad 1 funzione e flessibile conico 150 cm, tutto in ottone cromato.
 Art. A525: presa acqua tipo rotondo pesante in ottone cromato.
 Art. TK612: miscelatore incasso con deviatore e piastra lusso.
*Shower set composed by:
 Art A578CM20 A552CM30: ultra slim stainless steel mirror polished shower head Ø20 cm with antilimestone silicon jets, and arm in c.p. brass 30 cm.
 Art A335 A435 with A505X150: Minimal sliding bar with 1 function handshower, and shower flexible hose 150 cm, all in c.p. brass.
 Art. A525: C.p. brass wall connector, round heavy type
 Art. TK612: Built-in mixer with diverter and deluxe flange.*

TK615Z

Set doccia composto da:
 Art. A578CM20 A552CM30: soffione doccia ultra piatto Ø20 cm in acciaio INOX lucidato a specchio con getti anticalcare e braccio in ottone cromato 30 cm.
 Art. A546 A435 con A505X150: doccetta ad 1 funzione con supporto presa acqua e flessibile conico 150 cm, tutto in ottone cromato.
 Art. TK612: Miscelatore incasso con deviatore e piastra lusso.
*Shower set composed by:
 Art A578CM20 A552CM30: ultra slim stainless steel mirror polished shower head Ø20 cm with antilimestone silicon jets, and arm in c.p. brass 30 cm.
 Art. A546 A435 with A505X 150: water punch/shower holder with 1 function handshower and shower flexible hose 150 cm, all in c.p. brass.
 Art. TK612: Built-in mixer with diverter and deluxe flange.*

TK625Z

Set doccia composto da:
 Art. A578CM20 A552CM30: soffione doccia ultra piatto Ø20 cm in acciaio INOX lucidato a specchio con getti anticalcare e braccio in ottone cromato 30 cm.
 Art. TK625: miscelatore e deviatore su piastre separate.
 Art. A546 A435 con A505 150: doccetta ad 1 funzione con supporto presa acqua e flessibile conico 150 cm, tutto in ottone cromato.
*Shower set composed by:
 Art A578CM20 A552CM30: ultra slim stainless steel mirror polished shower head Ø20 cm with antilimestone silicon jets, and arm in c.p. brass 30 cm.
 Art. TK625: built-in shower mixer with diverter on double flange.
 Art. A546 A435 with A505 150: water punch/shower holder with 1 function handshower and shower flexible hose 150 cm, all in c.p. brass.*



STAINLESS
STEEL

TOKYO S T E E L

La collezione TOKYO STEEL viene interamente prodotta in acciaio INOX, racchiudendo in un design essenziale tutto il fascino estetico e pratico di questo materiale.

Le forme della rubinetteria sono slanciate, semplici e morbide, come la curvatura della sua bocca di erogazione che accompagna dolcemente il fluire dell'acqua.

Oltre alla bellezza e alla modernità del suo impatto visivo, TOKYO STEEL offre sul piano funzionale l'alta resistenza dell'acciaio inossidabile al tempo e all'usura.

La rubinetteria della serie TOKYO STEEL è disponibile in diverse altezze e composizioni per integrarsi al meglio in ogni soluzione di arredo.

TOKYO STEEL collection is entirely produced in stainless steel, enclosing in an essential design all the aesthetic and practical appeal of this material.

The shapes of faucets are slender, simple and smooth, like the curvature of the mouths that gently accompanies the water flow.

In addition to the beauty and modernity of its visual impact, TOKYO STEEL offers on the functional level the high strength of stainless steel at the time and usage.

The TOKYO STEEL faucets are available in different heights and compositions to best fit into every furnishing solution.



ANIMA & DESIGN
SOUL & DESIGN

FUSION

TOKYO

TOKYO
STEEL

DIVA
DEKORA
SENSE

SPEED
DEKORA
SENSE

TIARA

SKYLINE
DEKORA
SENSE

SUVI
DEKORA
SENSE

OXY
DEKORA
SENSE

JAX

KIR

TWIN
DEKORA
SENSE



CARATTERISTICHE TECNICHE:

La serie è dotata di cartuccia a dischi ceramici, Ø 25 mm, vasca ed incassi doccia Ø 35 mm prodotte da S.T.S.R. – Studio Tecnico Sviluppo e Ricerche - www.stsr.it

TECHNICAL CHARACTERISTICS:

The series is equipped with ceramic cartridge, Ø 25 mm, bath and shower mixers Ø 35 mm, produced by S.T.S.R. - Research Development Technical Office - www.stsr.it

LAVABI E BIDET - WASHBASIN MIXERS & BIDET MIXERS

SSTX605CC

Monocomando lavabo con scarico click-clack e senza foro sul corpo.
Altezza: 17,9 cm - Interasse: 11 cm
Single-lever basin mixer with click-clack waste and without body hole.
Height: 17,9 cm - Interaxis: 11 cm.



SSTX606N

Monocomando lavabo senza scarico e senza foro sul corpo.
Altezza: 17,9 cm - Interasse: 11 cm
Single-lever basin mixer without waste and without body hole.
Height: 17,9 cm - Interaxis: 11 cm.

SSTX607CC

Monocomando lavabo alto con scarico click-clack e senza foro sul corpo.
Altezza: 31,4 cm - Interasse: 16,5 cm
High basin mixer with click-clack waste and without body hole.
Height: 31,4 cm - Interaxis: 16,5 cm.



SSTX607BN

Monocomando lavabo alto senza scarico e senza foro sul corpo.
Altezza: 31,4 cm - Interasse: 16,5 cm
High basin mixer without waste and without body hole.
Height: 31,4 cm - Interaxis: 16,5 cm.

SSTX688

Miscelatore monocomando lavabo da pavimento con scarico click-clack e troppo pieno.
Altezza bocca: 92 cm - Interasse: 18 cm
Single-lever mixer floor mounting with click-clack waste and overflow.
Height spout: 92 cm - Interaxis: 18 cm.

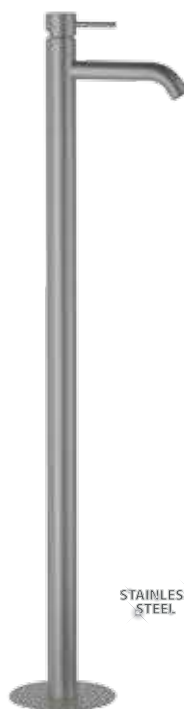

SSTX632P

Miscelatore monocomando a incasso per lavabo.
Lunghezza bocca: 16 cm.
Single-lever built-in basin mixer.
Length spout: 16 cm.



SSTX604CC

Monocomando bidet con scarico click-clack e senza foro sul corpo.
Altezza: 12,9 cm - Interasse: 9,5 cm
Single-lever bidet mixer with click-clack waste and without body hole.
Height: 12,9 cm - Interaxis: 9,5 cm.

SSTX604BN

Monocomando bidet senza scarico e senza foro sul corpo.
Altezza: 12,9 cm - Interasse: 9,5 cm
Single-lever bidet mixer without waste and without body hole.
Height: 12,9 cm - Interaxis: 9,5 cm.





MISCELATORI VASCA E DOCCIA - SHOWER AND BATH MIXERS



SSTX678

Miscelatore vasca da pavimento con deviatore e kit doccia.
Altezza bocca: 76 cm - Interasse: 18 cm
Free standing bath mixer floor mounting with diverter and shower kit.
Height spout: 76 cm - Interaxis: 18 cm.

STAINLESS
STEEL



SSA335 435

Saliscendi minimale con doccetta ad 1 funzione tutto in acciaio INOX spazzolato.
Altezza 96 cm.
Minimal sliding rail set with 1 function handshower all in brushed stainless steel.
Height 96 cm.

STAINLESS
STEEL



SSTX602

Miscelatore doccia incasso.
Built-in shower mixer.

STAINLESS
STEEL



SSTX4704 € 172,00

Bocca incasso.
Lunghezza bocca: 16,5 cm.
Built-in spout.
Length spout: 16,5 cm.

STAINLESS
STEEL



SSTX612D2P

Miscelatore monocomando per doccia con deviatore a 2 posizioni con doppia piastra.
Single-lever shower mixer, with 2 positions diverter with double flange.

STAINLESS
STEEL



SSTX612D3P

Miscelatore monocomando per doccia con deviatore a 3 vie e 3 posizioni (una entrata e tre uscite) con doppia piastra.
Single lever built-in shower mixer with 3 ways diverter and 3 positions (1 inlet and 3 outlets) with double flange.

STAINLESS
STEEL



Set doccia composto da:
 Art. SSA578 SSA555L: Soffione doccia ultra piatto e braccio tutto in acciaio INOX spazzolato.
 Art. SSA335 SSA435 con SSA516150: Saliscendi minimale con doccetta tutto in acciaio INOX spazzolato e flessibile conico in pvc color grigio acciaio.
 Art. SSA520: presa acqua tipo rotondo in acciaio INOX spazzolato.
 Art. SSTX612D2P: Miscelatore per doccia con deviatore a 2 posizioni in acciaio INOX spazzolato.
 Shower set composed by:
 Art. SSA578CM20 SSA555LCM30: ultra slim shower head with arm all in brushed stainless steel.
 Art. SSA335 SSA435 with SSA516150: Minimal sliding bar with minimal handshower, completely in brushed stainless steel with shower flexible hose in pvc steel grey colour cm 150.
 Art. SSA520: wall connector, round in brushed stainless steel.
 Art. SSTX612D2P: brushed stainless steel shower mixer, with 2 positions diverter.



Set doccia composto da:
 Art. SSA578 SSA555L: Soffione doccia ultra piatto e braccio tutto in acciaio INOX spazzolato.
 Art. SSA546 SSA435 con SSA516150: supporto lusso con presa acqua e doccetta tutto in acciaio INOX spazzolato e flessibile conico in pvc color grigio acciaio.
 Art. SSTX612D2P: Miscelatore per doccia con deviatore a 2 posizioni in acciaio INOX spazzolato.
 Shower set composed by:
 Art. SSA578CM20 SSA555LCM30: ultra slim shower head with arm all in brushed stainless steel.
 Art. SSA546 SSA435 with SSA516150: minimal shower holder with water punch with minimal handshower completely in brushed stainless steel with shower flexible hose in pvc steel grey colour cm 150.
 Art. SSTX612D2P: brushed stainless steel shower mixer, with 2 positions diverter.

SSTX614ZD2P7820

Disponibile con soffione da cm Ø20 cm e braccio a parete 30 cm.
 Available with head shower cm Ø20 cm and wall arm 30 cm.

SSTX614ZD2P7825

Disponibile con soffione da cm Ø25 cm e braccio a parete da 30 cm.
 Available with head shower cm Ø25 cm and wall arm 30 cm.

SSTX614ZD2P7830

Disponibile con soffione da cm Ø30 cm e braccio a parete da 30 cm.
 Available with head shower cm Ø30 cm and wall arm 30 cm.

SSTX614SD2P7820

Disponibile con soffione da cm Ø20 cm e braccio a soffitto da 30 cm.
 Available with head shower cm Ø20 cm and ceiling arm 30 cm.

SSTX615ZD2P7820

Disponibile con soffione da cm Ø20 cm e braccio a parete 30 cm.
 Available with head shower cm Ø20 cm and wall arm 30 cm.

SSTX615ZD2P7825

Disponibile con soffione da cm Ø25 cm e braccio a parete da 30 cm.
 Available with head shower cm Ø25 cm and wall arm 30 cm.

SSTX615ZD2P7830

Disponibile con soffione da cm Ø30 cm e braccio a parete da 30 cm.
 Available with head shower cm Ø30 cm and wall arm 30 cm.

SSTX615SD2P7820

Disponibile con soffione da cm Ø20 cm e braccio a soffitto da 30 cm.
 Available with head shower cm Ø20 cm and ceiling arm 30 cm.



Set doccia composto da:
 Art. SSA578 SSA555L: Soffione doccia ultra piatto e braccio tutto in acciaio INOX spazzolato.
 Art. SSA335 SSA435 con SSA516150: Saliscendi minimale con doccetta tutto in acciaio INOX spazzolato e flessibile conico in pvc color grigio acciaio.
 Art. SSA520: presa acqua tipo rotondo in acciaio INOX spazzolato.
 Art. SSTX612D3P: Miscelatore per doccia con deviatore a 3 posizioni in acciaio INOX spazzolato.
 Art. SSSJETX: 6 getti anticalcare in acciaio INOX spazzolato.
 Shower set composed by:
 Art. SSA578CM20 SSA555LCM30: ultra slim shower head with arm all in brushed stainless steel.
 Art. SSA335 SSA435 with SSA516150: Minimal sliding bar with minimal handshower, completely in brushed stainless steel with shower flexible hose in pvc steel grey colour cm 150.
 Art. SSA520: wall connector, round in brushed stainless steel.
 Art. SSTX612D3P: brushed stainless steel shower mixer, with 3 positions diverter.
 Art. SSSJETX: 6 antilimestone body jets in brushed stainless steel.

SSTX613ZP7820

Disponibile con soffione da cm Ø20 cm e braccio a parete 30 cm.
 Available with head shower cm Ø20 cm and wall arm 30 cm.

SSTX613ZP7825

Disponibile con soffione da cm Ø25 cm e braccio a parete da 30 cm.
 Available with head shower cm Ø25 cm and wall arm 30 cm.

SSTX613ZP7830

Disponibile con soffione da cm Ø30 cm e braccio a parete da 30 cm.
 Available with head shower cm Ø30 cm and wall arm 30 cm.

SSTX613SP7820

Disponibile con soffione da cm Ø20 cm e braccio a soffitto da 30 cm.
 Available with head shower cm Ø20 cm and ceiling arm 30 cm.

SSTX614ZPSSCA

Set doccia composto da:
 Art. SSA566CA: Soffione doccia a parete in acciaio INOX spazzolato 2 funzioni: pioggia e cascata.
 Art. SSA335 SSA435 con SSA516150: Saliscendi minimale con doccetta tutto in acciaio INOX spazzolato e flessibile conico in pvc color grigio acciaio.
 Art. SSA520: presa acqua tipo rotondo in acciaio INOX spazzolato.
 Art. SSTX612D3P: Miscelatore per doccia con deviatore a 3 posizioni in acciaio INOX spazzolato.
 Shower set composed by:
 Art. SSA566CA: brushed stainless steel wall shower head, 2 functions: rain and waterfall.
 Art. SSA335 SSA435 with SSA516150: Minimal sliding bar with minimal handshower, completely in brushed stainless steel with shower flexible hose in pvc steel grey colour cm 150.
 Art. SSA520: wall connector, round in brushed stainless steel.
 Art. SSTX612D3P: brushed stainless steel shower mixer, with 3 positions diverter.



Set doccia composto da:
 Art. SSA578 SSA555L: Soffione doccia ultra piatto e braccio tutto in acciaio INOX spazzolato.
 Art. SSA546 SSA435 con SSA516150: supporto lusso con presa acqua e doccetta tutto in acciaio INOX spazzolato e flessibile conico in pvc color grigio acciaio.
 Art. SSTX612D3P: Miscelatore per doccia con deviatore a 3 posizioni in acciaio INOX spazzolato.
 Art. SSSJETX: 6 getti anticalcare in acciaio INOX spazzolato.
 Shower set composed by:
 Art. SSA578CM20 SSA555LCM30: ultra slim shower head with arm all in brushed stainless steel.
 Art. SSA546 SSA435 with SSA516150: minimal shower holder with water punch with minimal handshower completely in brushed stainless steel with shower flexible hose in pvc steel grey colour cm 150.
 Art. SSTX612D3P: brushed stainless steel shower mixer, with 3 positions diverter.
 Art. SSSJETX: 6 antilimestone body jets in brushed stainless steel.

SSTX616ZP7820

Disponibile con soffione da cm Ø20 cm e braccio a parete 30 cm.
 Available with head shower cm Ø20 cm and wall arm 30 cm.

SSTX616ZP7825

Disponibile con soffione da cm Ø25 cm e braccio a parete da 30 cm.
 Available with head shower cm Ø25 cm and wall arm 30 cm.

SSTX616ZP7830

Disponibile con soffione da cm Ø30 cm e braccio a parete da 30 cm.
 Available with head shower cm Ø30 cm and wall arm 30 cm.

SSTX616SP7820

Disponibile con soffione da cm Ø20 cm e braccio a soffitto da 30 cm.
 Available with head shower cm Ø20 cm and ceiling arm 30 cm.

SSTX615ZPSSCA

Set doccia composto da:
 Art. SSA566CA: Soffione doccia a parete in acciaio INOX spazzolato 2 funzioni: pioggia e cascata.
 Art. SSA546 SSA435 con SSA516150: supporto lusso con presa acqua e doccetta tutto in acciaio INOX spazzolato e flessibile conico in pvc color grigio acciaio.
 Art. SSTX612D3P: Miscelatore per doccia con deviatore a 3 posizioni in acciaio INOX spazzolato.
 Shower set composed by:
 Art. SSA566CA: brushed stainless steel wall shower head, 2 functions: rain and waterfall.
 Art. SSA546 SSA435 with SSA516150: minimal shower holder with water punch with minimal handshower completely in brushed stainless steel with shower flexible hose in pvc steel grey colour cm 150.
 Art. SSTX612D3P: brushed stainless steel shower mixer, with 3 positions diverter.

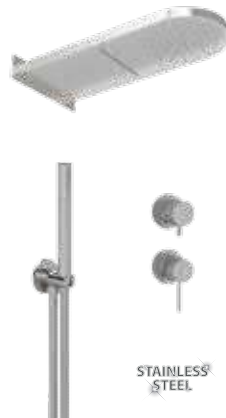



DIVA

DIVA è una collezione leggera e delicata, specchio di una raffinata cultura dell'abitare. Nata dal desiderio di massima proporzione, si fa portavoce di un'elegante modernità. Lo studio delle forme segue l'idea di una semplice linea che, curvandosi dolcemente, accentua e gioca con la propria femminilità.
Design di Cristian Mapelli.

*Diva is a light and delicate collection, mirror of a refined living culture. Born from the desire of highest proportion, it echoes of an elegant modernity. The study of shapes follows the idea of a simple line that, bending gently, accentuates and plays with her femininity.
Design By Cristian Mapelli.*





FINISHINGS

FIN 2

- CP cromo spazzolato brushed chrome
- NP nichel spazzolato brushed nickel
- NPO nichel spazzolato opaco matt brushed nickel
- 63 vecchio ottone old brass
- OIL oil bronze oil bronze
- 64 vecchio rame old copper
- 14 bianco opaco matt white
- 15 nero opaco matt black

FIN 4

- DO oro lucido shiny gold
- DP oro spazzolato brushed gold
- RL rame lucido shiny copper
- FZ cromo nero spazzolato lucido shiny brushed black chrome
- CF cromo nero lucido shiny black chrome
- GO grafite graphite

FIN 5

- PG oro rosa lucido shiny pink gold
- PP oro rosa spazzolato brushed pink gold
- RPO rame anodizzato anodised copper

Finiture consigliate per questa collezione.
Per l'elenco completo fare riferimento alla tabella delle finiture (pag.04)

*Suggested finishes for this collection.
For a complete list of available colors, please refer to the finishing table (page 04)*

DECORI DISPONIBILI:
AVAILABLE DECORATIONS:

MELODY YM



DECO 1

- YM81 cromo lucido, decoro oro spazzolato. shiny chrome, brushed gold decoration.

DECO 2

- YM84 nichel spazzolato, decoro cromo lucido. brushed nickel, shiny chrome decoration.
- YM86 nichel spazzolato, decoro canna di fucile spazzolato. brushed nickel, brushed gun barrel decoration..
- YM97 nichel spazzolato, decoro nichel lucido. brushed nickel, shiny nickel decoration,

DECO 4

- YM85 nichel spazzolato, decoro oro spazzolato. brushed nickel, brushed gold decoration.
- YM95 canna di fucile spazzolato, decoro cromo. brushed gun barrel, chrome decoration.
- YM98 ottone spazzolato decoro ottone lucido. brushed brass shiny brass decoration.

DECO 5

- YM82 oro lucido, decoro oro spazzolato. shiny gold, brushed gold decoration.
- YM83 oro lucido, decoro nichel spazzolato. shiny gold, brushed nickel decoration.
- YM88 oro antico, decoro canna di fucile spazzolato. antique gold, brushed gun barrel decoration.
- YM96 oro spazzolato, decoro cromo. brushed gold, chrome decoration.

DECO 6

- YM14 Bianco Opaco Matt White
- YM15 Nero Opaco Matt Black

DEKORA

SENSE

CARATTERISTICHE TECNICHE:

La serie è dotata di cartuccia a dischi ceramici Ø 25 mm, tranne gli incassi che utilizzano la cartuccia a dischi ceramici Ø 35 mm. Cartucce prodotte da S.T.S.R. – Studio Tecnico Sviluppo e Ricerche, www.stsr.it

TECHNICAL CHARACTERISTICS:

The series is equipped with ceramic cartridge Ø25 mm, except built-in items that use ceramic cartridge Ø35 mm,, Cartridges are produced by S.T.S.R. - Research Development Technical Office, www.stsr.it

LAVABI - WASHBASIN MIXERS



Monocomando lavabo
Altezza: 16 cm - Interasse: 10,6 cm
*Single-lever basin mixer.
Height: 16 cm - Interaxis: 10,6 cm.*

DV605

Con scarico.
With pop-up waste.

DV606

Senza scarico e senza foro nel corpo.
Without waste and without body hole.

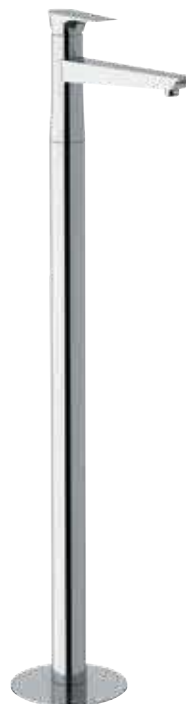

DV688

Miscelatore monocomando lavabo da pavimento con scarico click-clack con troppo pieno.
Altezza bocca: 94 cm - Interasse: 19 cm
*Single-lever mixer floor mounting with click clack with overflow waste.
Height spout: 94 cm - Interaxis: 19 cm.*



Monocomando lavabo alto.
Altezza: 22,5 cm - Interasse: 18 cm
*High basin mixer.
Height: 22,5 cm - Interaxis: 18 cm.*

DV607

Con scarico click-clack.
With click-clack waste.

DV607B

Senza scarico.
Without waste.



DV5022

Batteria lavabo da incasso.
Concealed basin mixer.



DV5003

Batteria lavabo con scarico.
Washbasin set with pop-up waste.



DV634

Miscelatore monocomando a incasso per lavabo.
Lunghezza bocca: 20,4 cm.
Single-lever built-in basin mixer.
Spout Length: 20,4 cm.



DV632

Miscelatore monocomando a incasso per lavabo.
Lunghezza bocca: 20,4 cm.
Single-lever built-in basin mixer.
Spout Length: 20,4 cm.



FUSION

TOKYO

TOKYO
STEEL

DIVA
DEKORA
SENSE

SPEED
DEKORA
SENSE

TIARA

SKYLINE
DEKORA
SENSE

SUVI
DEKORA
SENSE

LAVABO BOX INCASSO - BUILT-IN BOX WASHBASIN MIXER



DV632KB

Miscelatore monocomando a incasso per lavabo, con piastra in ottone cromato, bocca lunghezza 20,4 cm, da abbinare al box incasso.
Single-lever built-in basin mixer, with wall flange in chrome plated brass, spout length 20,4 cm, to match with the built-in box.

DAN BOX632

Box da incasso per miscelatore monocomando a incasso per lavabo.
Built-in box for single-lever built-in basin mixer.

OXY
DEKORA
SENSE

JAX

KIR

TWIN
DEKORA
SENSE

BIDET



Monocomando bidet.
Altezza: 13,5 cm - Interasse: 10,3 cm
Single-lever bidet mixer.
Height: 13,5 cm - Interaxis: 10,3 cm.

DV604 Con scarico.
With pop-up waste.

DV604B Senza scarico e senza foro nel corpo.
Without waste and without body hole.



DV646 Miscelatore incasso per shut-off.
Built-in shut-off mixer.



DV642 Miscelatore incasso per shut-off con doccetta shut-off, supporto doccia, presa acqua.
Built-in shut-off mixer set shut-off, shower holder, water punch.



DV6302 Batteria bidet con scarico.
Three holes bidet set with pop-up waste.



A758 Sifone in ottone cromato 1"1/4.
C.P. brass P trap 1"1/4.

MISCELATORI VASCA E DOCCIA - SHOWER AND BATH MIXERS



DV678 Miscelatore vasca da pavimento con deviatore e kit doccia.
Altezza bocca: 85 cm - Interasse: 19 cm.
Free standing bath mixer floor mounting with diverter and shower kit.
Height spout: 85 cm - Interaxis 19 cm.



Miscelatore vasca esterno.
Exposed bath mixer.

DV610 Con kit doccia, flessibile 150 cm.
With shower kit, flexible 150 cm.

DV600 Con kit doccia, flessibile 120 cm.
With shower kit, flexible 120 cm.

DV600H Senza kit doccia.
Without shower kit.



DV691
Miscelatore monocomando bordo vasca.
Single lever deck bath/shower mixer.



DV652
Miscelatore monocomando per vasca da
incasso, su piastra in ottone cromato.
*Single-lever bath mixer, with wall
flange in chrome plated.*



DV699
Miscelatore monocomando
bordo vasca con bocca
multigetto.
*Single lever deck bath/
shower mixer with multijet
spout.*



DV4491
Batteria bordo vasca con
doccetta estraibile.
*Bathtub set with pull-out
handshower.*



DV4192
Miscelatore bordo vasca quattro fori
con canna con deviatore e doccetta
estraibile.
*Deck bath set with diverter, casted
spout and pull-out handshower.*



DV611A
Miscelatore doccia esterno con
kit doccia.
*Exposed shower mixer with
shower kit.*



DV611
Miscelatore doccia esterno
senza kit doccia.
*Exposed shower mixer without
shower kit.*

FUSION

TOKYO

TOKYO
STEEL

DIVA
DEKORA
SENSE

SPEED
DEKORA
SENSE

TIARA

SKYLINE
DEKORA
SENSE

SUVI
DEKORA
SENSE

OXY
DEKORA
SENSE

JAX

KIR

TWIN
DEKORA
SENSE



A352 452
Kit saliscendi con doccetta ad 1 funzione.
Altezza: 87 cm.
Sliding rail set with 1 function handshower.
Height: 87 cm.



DV636B
Miscelatore doccia esterno con colonna doccia saliscendi, soffione in ottone cromato e doccetta ad 1 funzione.
Exposed shower mixer with sliding column, shower head in c.p. brass and 1 function handshower.





DV611Z
Monocomando doccia esterno
con attacco 3/4 M per colonna.
*Exposed shower mixer with
connection 3/4 M for columns.*



DV4454
Rubinetto doccia incasso 1/2".
Built-in right valve 1/2".

FUSION

TOKYO

TOKYO
STEEL

DIVA
DEKORA
SENSE

INCASSI DOCCIA - BUILT-IN MIXERS



DV602
Miscelatore doccia incasso.
Built-in shower mixer.



DV612
Miscelatore doccia incasso con deviatore.
Built-in bath/shower mixer with diverter.

IN602C35 Parte interna miscelatore monocomando incasso doccia.
Single-lever shower mixer (built-in components).

IN612C35 Parte interna miscelatore monocomando incasso vasca/doccia con deviatore.
Single-lever bath/shower mixer with diverter (built-in components).

DV602EKIT Parte esterna miscelatore monocomando incasso doccia.
Single-lever shower mixer (external components).

DV612EKIT Parte esterna miscelatore monocomando incasso vasca/doccia con deviatore.
Single-lever bath/shower mixer with diverter (external components).

SPEED
DEKORA
SENSE

TIARA

SKYLINE
DEKORA
SENSE



DV602B
Monocomando doccia incasso con piastra
Diva Dance On.
*Single-lever built-in shower mixer with Diva
Dance On Plate.*



DV612B
Monocomando vasca incasso con piastra Diva
Dance On e deviatore.
*Single lever built-in bath mixer with Diva Dance
On Plate and diverter.*

SUVI
DEKORA
SENSE

OXY
DEKORA
SENSE

JAX



DV602C
Monocomando doccia incasso
con piastra Celebrativa Diva
Edizione Limitata.
*single-lever built-in shower
mixer with Celebrative Diva plate
Limited Edition.*



DV612C
Monocomando vasca incasso
con piastra Celebrativa Diva
Edizione Limitata e deviatore.
*Built-in bath/shower mixer with
Celebrative Diva plate Limited
Edition and diverter.*

KIR

TWIN
DEKORA
SENSE

BOX INCASSO - BUILT-IN BOX

DV602KB

Set miscelatore doccia da abbinare al box incasso.
Shower mixer set to match with the built-in box.



DAN BOX

Box da incasso per miscelatore doccia con deviatore.
Built-in box for shower mixer with diverter.

DV612KB

Set miscelatore doccia con deviatore da abbinare al box incasso.
Shower mixer set with diverter to match with the built-in box.



DAN BOX

Box da incasso per miscelatore doccia con deviatore.
Built-in box for shower mixer with diverter.

DV612D2KB

Set miscelatore doccia due vie da abbinare al box incasso.
Two ways shower mixer set to match with the built-in box.



DAN BOXD2

Box da incasso per miscelatore doccia due vie.
Built-in box for two ways shower mixer.

DV612D3KB

Set miscelatore doccia tre vie da abbinare al box incasso.
Three ways shower mixer set to match with the built-in box.



DAN BOXD3

Box da incasso per miscelatore doccia tre vie.
Built-in box for three ways shower mixer.

DV612D7KB

Set miscelatore doccia tre vie e sette posizioni da abbinare al box incasso.
Three ways and seven positions shower mixer set to match with the built-in box.



DAN BOXD3

Box da incasso per miscelatore doccia tre vie.
Built-in box for three ways shower mixer.

DEVIATORI - DIVERTERS



DV612Z DEV7

Deviatore a 3 vie e 7 posizioni.
Diverter 3 ways and 7 positions.



DV612Z DEV3

Deviatore a 3 vie e 3 posizioni.
Diverter 3 ways and 3 positions.

FUSION

TOKYO

BOCCE E SOFFIONI - SPOUTS & SHOWER HEAD

TOKYO

STEEL



DC4704

Bocca incasso a cascata.
Built-in spout with waterfall.



DV4704

Bocca incasso 20 cm.
Built-in spout 20 cm.

DIVA

DEKORA
SENSE



SPEED

DEKORA
SENSE

TIARA

SKYLINE

DEKORA
SENSE

SUVI

DEKORA
SENSE

OXY

DEKORA
SENSE

JAX



F4705

Bocca bordo vasca con effetto multigetto.
*Spout with multijet effect for deck bath/
shower mixer.*



A594DC

Soffione doccia con getto a cascata.
Shower head with waterfall jet.

KIR

TWIN

DEKORA
SENSE



DV614ZC

Set doccia con soffione doccia a cascata, miscelatore vasca incasso con deviatore Diva, saliscendi con doccetta Diva ad 1 funzione e flessibile 150 cm, attacco presa acqua da 1/2 tipo rotondo pesante; tutto in ottone cromato.

Shower set with waterfall shower head, built in bath mixer with diverter, Diva sliding rail with 1 function Diva handshower and 150 cm flexible hose, water punch connector round heavy type; all in c.p. brass



DV4440

Batteria incasso vasca con deviatore, doccetta Diva ad 1 funzione, supporto presa acqua e flessibile conico 150 cm, bocca a parete Diva, tutto in ottone cromato.

Built-in bathtub mixer with diverter, water punch/shower holder, Diva 1 function handshower and shower flexible hose 150 cm, built-in spout; all in c.p. brass.



DV4441

Batteria incasso doccia con deviatore, doccetta Diva ad 1 funzione, supporto presa acqua e flessibile conico 150 cm, braccio 30 cm e soffione Ø 35 cm; tutto in ottone cromato.

Built-in shower mixer with diverter, water punch/shower holder, Diva 1 function handshower and shower flexible hose 150 cm, showerhead Ø 30 cm and arm 35 cm; all in c.p. brass.





DV4441CA

Batteria incasso doccia con deviatore, soffione doccia a cascata, doccietta Diva ad 1 funzione, supporto presa acqua e flessibile conico 150 cm.; tutto in ottone cromato.
Built-in shower mixer with diverter, waterfall shower head, built in bath mixer with diverter, water punch/shower holder, Diva 1 function handshower and shower flexible hose 150 cm; all in c.p. brass.



DV4442CA

Batteria incasso doccia con deviatore, soffione doccia a cascata, saliscendi con doccetta Diva ad 1 funzione e flessibile 150 cm, attacco presa acqua da 1/2 tipo rotondo pesante; tutto in ottone cromato.
Built-in shower mixer with diverter, waterfall shower head, built in bath mixer with diverter, Diva sliding rail with 1 function Diva handshower and 150 cm flexible hose, water punch connector round heavy type; all in c.p. brass

FUSION

TOKYO

TOKYO
STEEL

DIVA
DEKORA
SENSE

SPEED
DEKORA
SENSE

CUCINA - KITCHEN

TIARA

SKYLINE
DEKORA
SENSE

SUVI
DEKORA
SENSE

OXY
DEKORA
SENSE

JAX

KIR

TWIN
DEKORA
SENSE



DV608

Monocomando lavello girevole.
Altezza: 22,7 cm - Interasse: 18 cm.
*Swivelling single-lever Sink mixer.
Height: 22,7 cm - Interaxis: 18 cm.*





SPEED

Le linee della serie Speed sono ispirate alle modernissime forme del mondo dell'aeronautica. Aerodinamicità e leggerezza sono le caratteristiche che contraddistinguono tutte le parti della collezione.
Design di Cristian Mapelli.

*The lines of Speed serie are inspired by the modern shapes of the aeronautics world. Aerodynamic and lightness are the characteristics that distinguish all the parts of this collection.
Design By Cristian Mapelli*

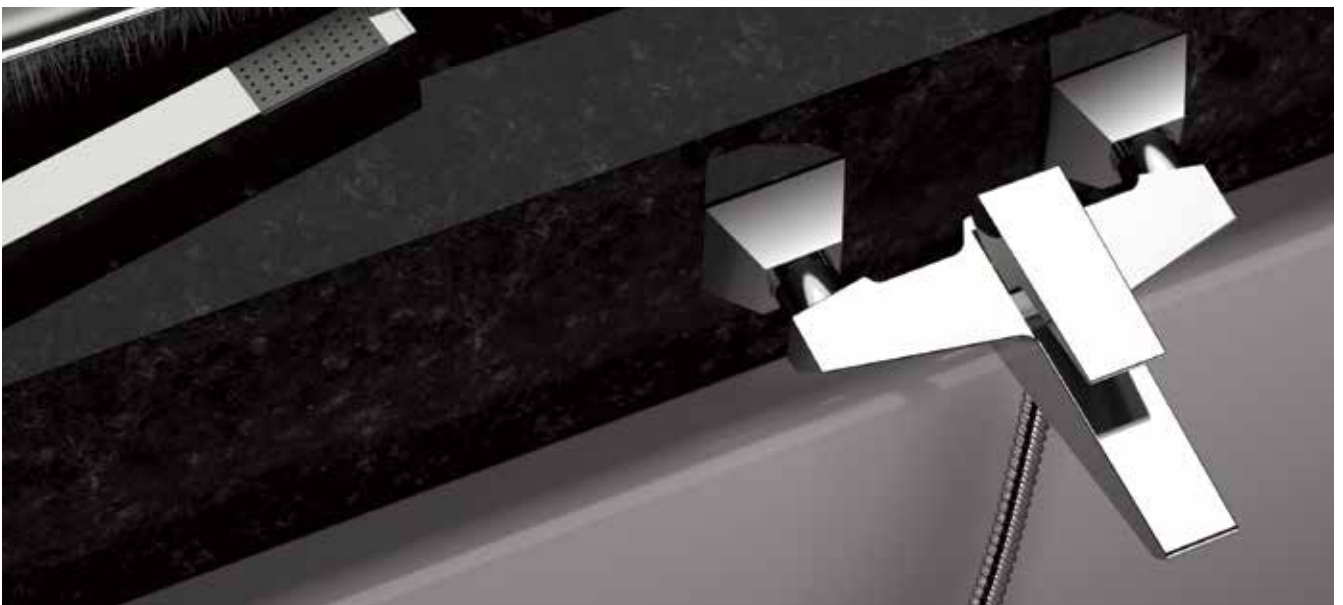

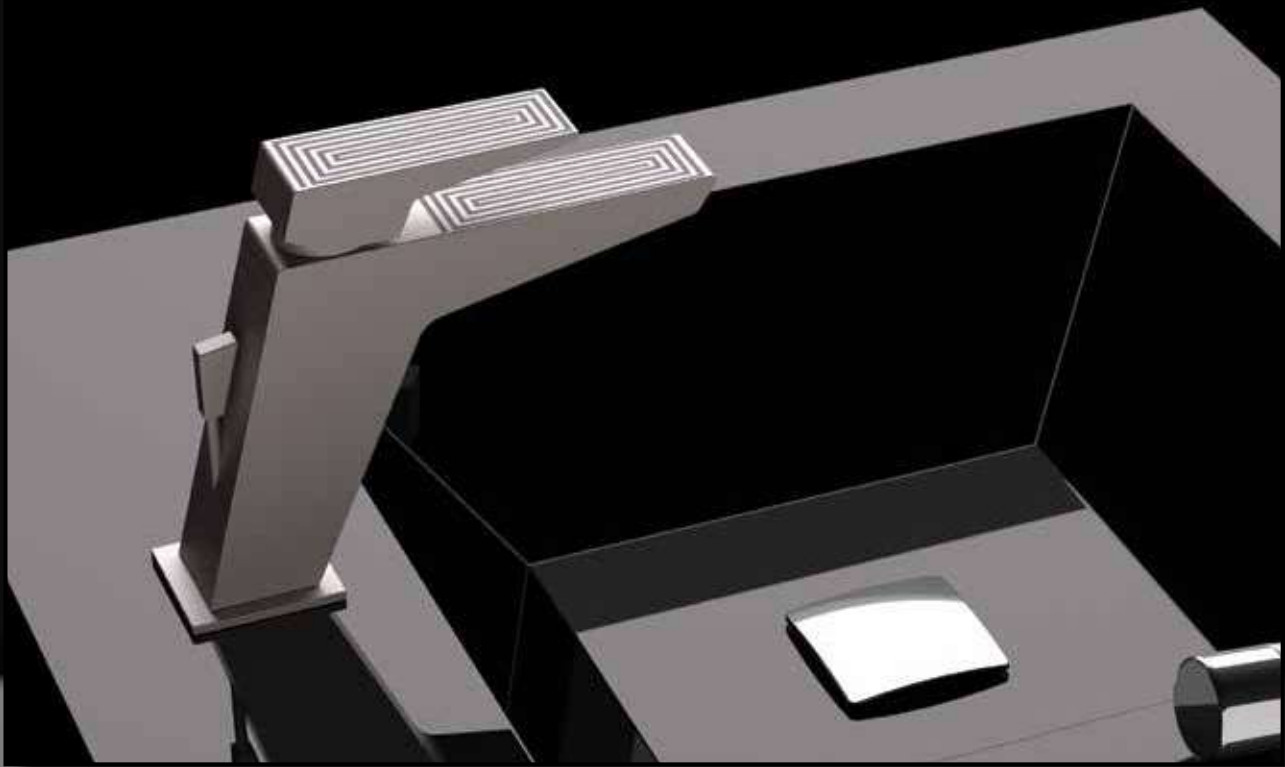

FINISHINGS

FIN 2			
CP cromo spazzolato brushed chrome	NP nichel spazzolato brushed nickel	NPO nichel spazzolato opaco matt brushed nickel	63 vecchio ottone old brass
64 vecchio rame old copper	14 bianco opaco matt white	15 nero opaco matt black	OIL oil bronze oil bronze
FIN 4			
DO oro lucido shiny gold	DP oro spazzolato brushed gold	RL rame lucido shiny copper	FZ cromo nero spazzolato lucido shiny brushed black chrome
FIN 5		CF cromo nero lucido shiny black chrome	GO grafite graphite
PG oro rosa lucido shiny pink gold	PP oro rosa spazzolato brushed pink gold	RPO rame anodizzato anodised copper	

Finiture consigliate per questa collezione.
Per l'elenco completo fare riferimento alla tabella delle finiture (pag.04)

*Suggested finishes for this collection.
For a complete list of available colors, please refer to the finishing table (page 04)*

DECORI DISPONIBILI:
AVAILABLE DECORATIONS:

RACING **YR**

ELEGANCE **YE**

DECO 1		DECO 2			
YE80 cromo lucido, decoro nichel spazzolato. shiny chrome, brushed nickel decoration.	YR80	YE84 nichel spazzolato, decoro cromo lucido. brushed nickel, shiny chrome decoration.	YR84	YE86 nichel spazzolato, decoro canna di fucile spazzolato. brushed nickel, brushed gun barrel decoration.	YR86
		YE97 nichel spazzolato, decoro nichel lucido. brushed nickel, shiny nickel decoration.	YR97	YE3A nichel spazzolato, decoro canna di fucile lucido. brushed nickel, shiny gun barrel decoration.	YR4A
DECO 4					
YR85 nichel spazzolato, decoro oro spazzolato. brushed nickel, brushed gold decoration.	YE95 canna di fucile spazzolato, decoro cromo. brushed gun barrel, chrome decoration.	YR95	YE5A canna di fucile, decoro canna di fucile lucido. gun barrel, shiny gun barrel decoration.	YR5A	YE2A canna di fucile spazzolato, decoro nichel spazzolato. brushed gun barrel, brushed nickel decoration.
YE85			YR2A		
DECO 5					
YE1A canna di fucile lucido, decoro oro lucido. shiny gun barrel, shiny gold decoration.	YR1A	YE4A oro spazzolato, decoro canna di fucile lucido. brushed gold, shiny gun barrel decoration.	YR4A	YE99 oro spazzolato, decoro nichel spazzolato. brushed gold, brushed nickel decoration.	YR99
DECO 6					
YE14 Bianco Opaco Matt White	YR14	YE15 Nero Opaco Matt Black	YR15		
YR14					

DEKORA

SENSE

CARATTERISTICHE TECNICHE:

La serie è dotata di cartuccia a dischi ceramici Ø 25 mm, tranne gli incassi che utilizzano la cartuccia a dischi ceramici Ø 35 mm. Cartucce prodotte da S.T.S.R. - Studio Tecnico Sviluppo e Ricerche, www.stsr.it

TECHNICAL CHARACTERISTICS:

The series is equipped with ceramic cartridge Ø25 mm, except built-in items that use ceramic cartridge Ø35 mm. Cartridges are produced by S.T.S.R. - Research Development Technical Office, www.stsr.it

LAVABI - WASHBASIN MIXERS



Monocomando lavabo
Altezza: 14,3 cm - Interasse: 13,4 cm
Single-lever basin mixer.
Height: 14,3 cm - Interaxis: 13,4 cm.

SP605

Con scarico.
With pop-up waste.

SP606

Senza scarico.
Without waste.



Monocomando lavabo alto.
Altezza: 28,7 cm - Interasse: 18 cm
High basin mixer.
Height: 28,7 cm - Interaxis: 18 cm.

SP607

Con scarico click-clack.
With click-clack waste.

SP607B

Senza scarico.
Without waste.

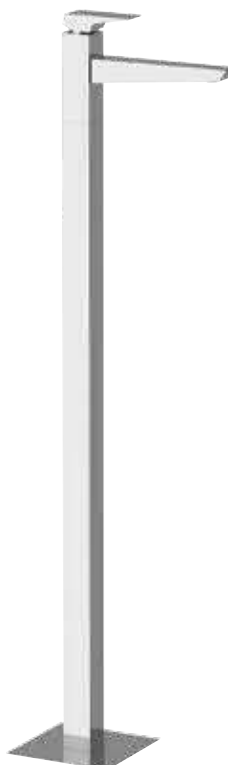

SP688

Miscelatore monocomando lavabo da pavimento con click-clack e troppo pieno.

Altezza bocca: 94 cm - Interasse: 20 cm
Single-lever mixer floor mounting with click-clack and overflow
Height spout: 94 cm - Interaxis: 20 cm.



SP632

Miscelatore monocomando a incasso per lavabo, con piastra verticale.
Lunghezza bocca: 20 cm.
Single-lever built-in basin mixer, with wall flange.
Spout length: 20 cm.



SP634

Miscelatore monocomando a incasso per lavabo, con piastra verticale.

Lunghezza bocca: 20 cm.
Single-lever built-in basin mixer, with vertical wall flange.
Spout length: 20 cm.

FUSION

TOKYO

TOKYO
STEEL

DIVA
DEKORA
SENSE

SPEED
DEKORA
SENSE

TIARA

SKYLINE
DEKORA
SENSE

SUVI
DEKORA
SENSE

OXY
DEKORA
SENSE

JAX

KIR

TWIN
DEKORA
SENSE



LAVABO BOX INCASSO - BUILT-IN BOX WASHBASIN MIXER



SP632KB

Miscelatore monocomando a incasso per lavabo, con piastra in ottone cromato, bocca lunghezza 20 cm, da abbinare al box incasso.

Single-lever built-in basin mixer, with wall flange in chrome plated brass, spout length 20 cm, to match with the built-in box.

+

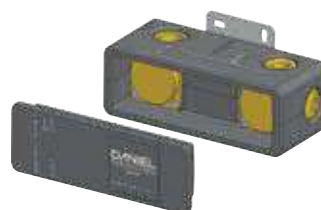

DAN BOX632

Box da incasso per miscelatore monocomando a incasso per lavabo.
Built-in box for single-lever built-in basin mixer.



Monocomando bidet.
Altezza: 12,4 cm - Interasse: 12,4 cm
Single-lever bidet mixer.
Height: 12,4 cm - Interaxis: 12,4 cm.

SP604

Con scarico.
With pop-up waste.

SP604B

Senza scarico.
Without waste.



SP642

Miscelatore incasso per shut-off con
doccetta shut-off, supporto doccia,
presa acqua.
*Built-in shut-off mixer set with shut-off,
shower holder, water punch.*



INCASSI DOCCIA E BOCCHE - BUILT-IN MIXERS & SPOUTS



SP602

Miscelatore doccia incasso.
Built-in shower mixer.



SP612

Miscelatore vasca doccia incasso con
deviatore.
Built-in bath/shower mixer with diverter.

IN602C35

Parte interna miscelatore monocomando incasso doccia.
Single-lever shower mixer (built-in components).

IN612C35

Parte interna miscelatore monocomando incasso
vasca/doccia con deviatore.
*Single-lever bath/shower mixer with diverter (built-in
components).*

SP602EKIT

Parte esterna miscelatore monocomando incasso doccia.
Single-lever shower mixer (external components).

SP612EKIT

Parte esterna miscelatore monocomando incasso
vasca/doccia con deviatore.
*Single-lever bath/shower mixer with diverter (external
components).*



SP4704

Bocca incasso.
Lunghezza: 19 cm.
Built-in spout.
Length: 19 cm.

BOX INCASSO - BUILT-IN BOX

SP602KB

Set miscelatore doccia da abbinare al box incasso.
Shower mixer set to match with the built-in box.

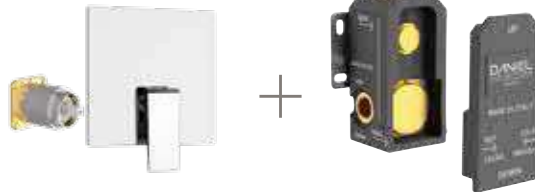

DAN BOX

Box da incasso per miscelatore doccia con deviatore.
Built-in box for shower mixer with diverter.

FUSION

TOKYO

SP612KB

Set miscelatore doccia con deviatore da abbinare al box incasso.
Shower mixer set with diverter to match with the built-in box.



DAN BOX

Box da incasso per miscelatore doccia con deviatore.
Built-in box for shower mixer with diverter.

TOKYO
STEEL

DIVA

DEKORA
SENSE

SP612D2KB

Set miscelatore doccia due vie da abbinare al box incasso.
Two ways shower mixer set to match with the built-in box.



DAN BOXD2

Box da incasso per miscelatore doccia due vie.
Built-in box for two ways shower mixer.

SPEED
DEKORA
SENSE

TIARA

SP612D3KB

Set miscelatore doccia tre vie da abbinare al box incasso.
Three ways shower mixer set to match with the built-in box.



DAN BOXD3

Box da incasso per miscelatore doccia tre vie.
Built-in box for three ways shower mixer.

SKYLINE
DEKORA
SENSE

SUVI

DEKORA
SENSE

OXY

DEKORA
SENSE

SP612D7KB

Set miscelatore doccia tre vie e sette posizioni da abbinare al box incasso.
Three ways and seven positions shower mixer set to match with the built-in box.

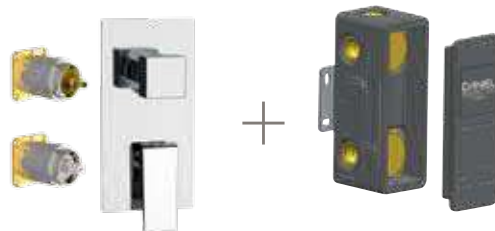

DAN BOXD3

Box da incasso per miscelatore doccia tre vie.
Built-in box for three ways shower mixer.

JAX

KIR

TWIN
DEKORA
SENSE

MISCELATORI VASCA E DOCCIA - SHOWER AND BATH MIXERS



Miscelatore vasca esterno.
Exposed bath mixer.

SP610 Con kit doccia, flessibile 150 cm.
With shower kit, flexible 150 cm.

SP600 Con kit doccia, flessibile 120 cm.
With shower kit, flexible 120 cm.

SP600H Senza kit doccia.
Without shower kit.



Monocomando doccia esterno.
Exposed shower mixer.

SP631A Con kit doccia.
With shower kit.

SP631 Senza kit doccia.
Without shower kit.



SP678
Miscelatore vasca da pavimento con deviatore e kit doccia.
Altezza bocca: 78 cm - Interasse: 20 cm.
Free standing bath mixer floor mounting with diverter and shower kit.
Height spout: 78 cm - Interaxis: 20 cm.



A355 495
Saliscendi rettangolare ultraflat con doccetta quadrata ad 1 funzione, tutto in ottone cromato.
Altezza: 70 cm.
Ultraflat rectangular sliding rail and 1 function squared handshower, all in c.p. brass.
Height: 70 cm.



FUSION

TOKYO

TOKYO
STEEL

DIVA
DEKORA
SENSE

SPEED
DEKORA
SENSE

TIARA

KIT WELLNESS - WELLNESS KIT



SP614ZSS

Set doccia con soffione doccia a parete in acciaio INOX lucidato a specchio getto pioggia, saliscendi con doccetta ad 1 funzione in ottone cromato, flessibile conico in ottone cromato cm 150, presa acqua lusso quadrata, miscelatore vasca doccia incasso con deviatore.
Shower set with stainless steel mirror polished wall shower head with rain jet, deluxe sliding rail with c.p. brass hand shower 1 function, shower flexible hose in brass cm 150, luxury water punch, built-in bath/shower mixer with diverter.



SP615ZSS

Set doccia con soffione doccia a parete in acciaio INOX lucidato a specchio con getto pioggia, supporto doccia deluxe duplex con presa acqua, doccetta ad 1 funzione in ottone cromato e flessibile conico in ottone cromato 150 cm, miscelatore vasca doccia incasso con deviatore.
Shower set with stainless steel mirror polished wall shower head with rain jet, duplex deluxe shower holder with water punch in c.p. brass, with 1 function c.p. brass handshower, flexible hose in c.p. brass 150 cm, built-in bath/shower mixer with diverter.

SKYLINE
DEKORA
SENSE

SUVI
DEKORA
SENSE

OXY
DEKORA
SENSE

JAX

KIR

TWIN
DEKORA
SENSE



TIARA

Tiara è la combinazione ideale tra linee curve e facce rigide. La presenza frontale di superfici sfaccettate come diamanti caratterizza il design di tutti gli elementi. Il risultato è una perfetta armonia estetica, esaltata dalle molteplici riflessioni di luce dell'ambiente circostante, che diversificano la serie da ogni altro prodotto in commercio.
Design di Cristian Mapelli

TIARA is the ideal combination of curved lines and stiff facets. The presence of frontal faceted surfaces like diamonds characterizes the design of all elements. The result is a perfect aesthetic harmony, enhanced by multiple ambient light reflections differentiating the series from any other product on the market.
Design By Cristian Mapelli

FINISHINGS

CP cromo spazzolato
brushed chrome

64 vecchio rame
old copper

NP nichel spazzolato
brushed nickel

14 bianco opaco
matt white

FIN 2

NPO nichel spazzolato opaco
matt brushed nickel

15 nero opaco
matt black

63 vecchio ottone
old brass

OIL oil bronze
oil bronze

DO oro lucido
shiny gold

GO grafite
graphite

DP oro spazzolato
brushed gold

FZ cromo nero spazzolato lucido
shiny brushed black chrome

CF cromo nero lucido
shiny black chrome

RL rame lucido
shiny copper

FIN 5

PG oro rosa lucido
shiny pink gold

PP oro rosa spazzolato
brushed pink gold

RPO rame anodizzato
anodised copper

Finiture consigliate per questa collezione.
Per l'elenco completo fare riferimento alla tabella delle finiture (pag.04)

*Suggested finishes for this collection.
For a complete list of available colors, please refer to the finishing table (page 04)*



ANIMA & DESIGN
SOUL & DESIGN

FUSION

TOKYO

TOKYO
STEEL

DIVA
DEKORA
SENSE

SPEED
DEKORA
SENSE

TIARA

SKYLINE
DEKORA
SENSE

SUVI
DEKORA
SENSE

OXY
DEKORA
SENSE

JAX

KIR

TWIN
DEKORA
SENSE



TIARA

CARATTERISTICHE TECNICHE:

La serie è dotata di cartuccia a dischi ceramici Ø 35 mm, prodotta da S.T.S.R. - Studio Tecnico Sviluppo e Ricerche - www.stsr.it

TECHNICAL CHARACTERISTICS:

The series is equipped with ceramic cartridge Ø 35 mm, produced by S.T.S.R. - Research Development Technical Office - www.stsr.it



Doccetta cromata a 4 funzioni con pulsante per il cambio dell'intensità del getto, con getti anticalcare in silicone.

C.p. handshower 4 functions with button to change the intensity of the jet, anti-limestone with silicone jets.

LAVABI - WASHBASIN MIXERS



Monocomando lavabo
Altezza: 16,7 cm - Interasse: 12 cm
Single-lever basin mixer.
Height: 16,7 cm - Interaxis: 12 cm.

TA605

Con scarico.
With pop-up waste.

TA606

Senza scarico.
Without waste.

TA606N

Senza scarico e senza foro sul corpo.
Without waste and without body hole.



Monocomando lavabo XL.
Altezza: 29,8 cm - Interasse: 18,5 cm
XL basin mixer.
Height: 29,8 cm - Interaxis: 18,5 cm.

TA607

Con scarico click-clack.
With pop-up waste.

TA607B

Senza scarico.
Without waste.

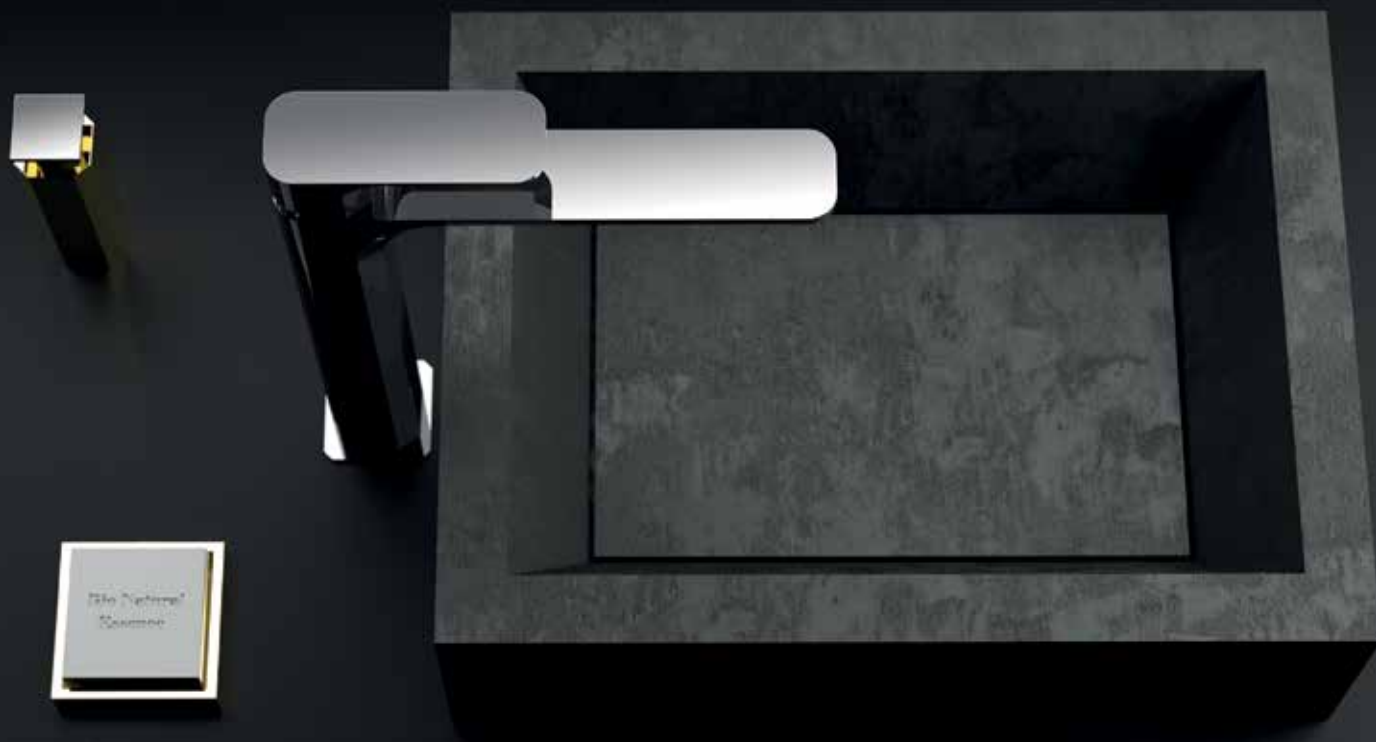

TA634

Miscelatore monocomando a incasso per lavabo, con piastra rettangolare verticale.
Lunghezza bocca: 19 cm.
Single-lever built-in basin mixer, with vertical rectangular wall flange.
Spout length: 19 cm.



TA632

Miscelatore monocomando a incasso per lavabo, con piastra rettangolare.
Lunghezza bocca: 19 cm.
Single-lever built-in basin mixer, with rectangular wall flange.
Spout length: 19 cm.



TA632P
Miscelatore lavabo da incasso.
Lunghezza bocca: 19 cm.
Concealed washbasin mixer.
Spout length: 19 cm.



TA655
Miscelatore monocomando lavabo due fori.
Altezza: 23,2 cm - Interasse: 17,2 cm
Two holes single-lever washbasin mixer.
Height: 23,2 cm - Interaxis: 17,2 cm.

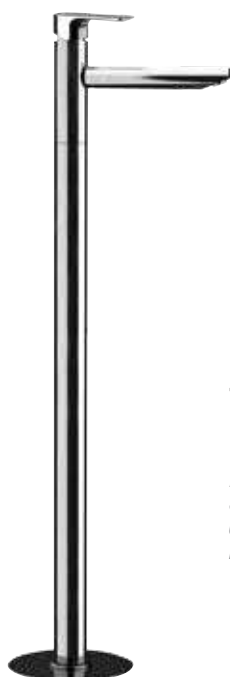

TA688
Miscelatore monocomando lavabo da pavimento con click-clack e troppo pieno.
Altezza bocca: 92,5 cm - Interasse: 22 cm
Single-lever mixer floor mounting with click-clack and overflow.
Height spout: 92,5 cm - Interaxis: 22 cm.

FUSION

TOKYO

TOKYO
STEEL

DIVA
DEKORA
SENSE

LAVABO BOX INCASSO - BUILT-IN BOX WASHBASIN MIXER



TA632KB

Miscelatore monocomando a incasso per lavabo, con piastra in ottone cromato, bocca lunghezza 19 cm, da abbinare al box incasso.
Single-lever built-in basin mixer, with wall flange in chrome plated brass, spout length 19 cm, to match with the built-in box.

DAN BOX632

Box da incasso per miscelatore monocomando a incasso per lavabo.
Built-in box for single-lever built-in basin mixer.

SPEED
DEKORA
SENSE

TIARA

SKYLINE
DEKORA
SENSE

SUVI
DEKORA
SENSE

BIDET



TA604

Miscelatore bidet.
Altezza: 14,2 cm - Interasse: 11,4 cm
Bidet mixer.
Height: 14,2 cm - Interaxis: 11,4 cm.

Con scarico.
With pop-up waste.

TA604B

Senza scarico.
Without waste.



Miscelatore incasso per shut-off .
Built-in shower mixer.

TA645

comprensivo di doccetta shut-off art. 1000DC, supporto doccia-presa acqua, tutto in ottone cromato e flessibile doccia cm 120.
including: shut-off art. 1000DC, shower holder-water punch on flange, all in c.p. brass and shower flexible cm 120.

TA645H

Miscelatore incasso per shut-off su piastra in ottone cromato.
Built-in shower mixer all in c.p. brass.

OXY
DEKORA
SENSE

JAX

KIR

TWIN
DEKORA
SENSE

INCASSI DOCCIA E BOCCHIE - BUILT-IN MIXERS & SPOUTS



TA602
Miscelatore doccia incasso.
Built-in shower mixer.



TA612
Miscelatore vasca/doccia incasso con deviatore.
Built-in bath/shower mixer with diverter.

IN602C35 Parte interna miscelatore monocomando incasso doccia.
Single-lever shower mixer (built-in components).

TA602EKIT Parte esterna miscelatore monocomando incasso doccia.
Single-lever shower mixer (external components).

IN612C35 Parte interna miscelatore monocomando incasso vasca/doccia con deviatore.
Single-lever bath/shower mixer with diverter (built-in components).

TA612EKIT Parte esterna miscelatore monocomando incasso vasca/doccia con deviatore.
Single-lever bath/shower mixer with diverter (external components).



TA612D2
Miscelatore monocomando per doccia con deviatore a 2 posizioni su piastra unica.
Single-lever shower mixer, with 2 positions diverter on single flange.



TA612D3
Miscelatore monocomando per doccia con deviatore a 3 vie e 3 posizioni (una entrata e tre uscite) su unica piastra.
Single lever built-in shower mixer with 3 ways diverter and 3 positions (1 inlet and 3 outlets) on single flange.



TA612D7
Miscelatore monocomando per doccia con deviatore a tre vie e sette posizioni su unica piastra.
Single lever built-in shower mixer with three ways diverter with seven positions on single flange.



TA4704
Bocca incasso. Altezza: 19,4 cm.
Built-in spout. Height: 19,4 cm.

BOX INCASSO - BUILT-IN BOX

TA602KB

Set miscelatore doccia da abbinare al box incasso.
Shower mixer set to match with the built-in box.



+



DAN BOX

Box da incasso per miscelatore doccia con deviatore.
Built-in box for shower mixer with diverter.

FUSION

TOKYO

TOKYO
STEEL

TA612KB

Set miscelatore doccia con deviatore da abbinare al box incasso.
Shower mixer set with diverter to match with the built-in box.



+



DAN BOX

Box da incasso per miscelatore doccia con deviatore.
Built-in box for shower mixer with diverter.

DIVA

DEKORA
SENSE

SPEED

DEKORA
SENSE

TA612D2KB

Set miscelatore doccia due vie da abbinare al box incasso.
Two ways shower mixer set to match with the built-in box.



+



DAN BOXD2

Box da incasso per miscelatore doccia due vie.
Built-in box for two ways shower mixer.

TIARA

SKYLINE

DEKORA
SENSE

TA612D3KB

Set miscelatore doccia tre vie da abbinare al box incasso.
Three ways shower mixer set to match with the built-in box.



+



DAN BOXD3

Box da incasso per miscelatore doccia tre vie.
Built-in box for three ways shower mixer.

SUVI

DEKORA
SENSE

OXY

DEKORA
SENSE

JAX

TA612D7KB

Set miscelatore doccia tre vie e sette posizioni da abbinare al box incasso.
Three ways and seven positions shower mixer set to match with the built-in box.



+



DAN BOXD3

Box da incasso per miscelatore doccia tre vie.
Built-in box for three ways shower mixer.

KIR

TWIN

DEKORA
SENSE

MISCELATORI VASCA E DOCCIA - SHOWER AND BATH MIXERS



Miscelatore vasca esterno.
Exposed bath mixer.

TA610 Con kit doccia, flessibile 150 cm.
With shower kit, flexible 150 cm.

TA600H Senza kit doccia.
Without shower kit.



Monocomando doccia esterno.
Exposed shower mixer.

TA631A Con kit doccia, flessibile 150 cm.
With shower kit, flexible 150 cm.

TA631 Senza kit doccia.
Without shower kit.



Miscelatore vasca/doccia.
Bath/shower mixer..

TA600DH con attacco alto da 1/2" ed attacco inferiore da 1/2".
with upper 1/2" connection and lower connection 1/2".

TA600DH34 con attacco alto da 3/4" ed attacco inferiore da 1/2".
with upper 3/4" connection and lower connection 1/2".



TA678 Miscelatore vasca da pavimento con deviatore e kit doccia.
Altezza bocca: 78 cm - Interasse: 18 cm.
Free standing bath mixer floor mounting with diverter and shower kit.
Height spout: 78 cm - Interaxis: 18 cm.



A388 3CP Saliscendi cromato con asta minimale ovale dritta e doccetta cromata a 4 funzioni con pulsante per il cambio dell'intensità del getto, con getti anticalcare in silicone.
Altezza: 65 cm.
C.p. sliding rail set with minimal oval rod and c.p. handshower 4 functions with button to change the intensity of the jet, anti-limestone with silicone jets.
Height: 65 cm.

COLONNE DOCCIA - SHOWER COLUMN



TA636DA7720

Miscelatore vasca/doccia serie Tiara con attacco alto da 3-4" ed attacco inferiore da 1/2", con colonna doccia telescopica, doccetta anticalcare a 4 funzioni, con flessibile A505X 150 cm e soffione doccia quadrato con angoli arrotondati ultrapiatto in acciaio INOX 20x20 cm lucidato a specchio con getti in silicone anticalcare.

Bath/shower mixer Tiara series with upper 3/4" connection and lower connection 1/2", with telescopic shower column, c.p. handshower 4 functions antilimestone, with A505X 150 cm flexible hose and squared with rounded corners ultra slim stainless steel mirror polished shower head 20x20 cm, with anti-limestone silicon jets.



TA636DAAD20

Miscelatore vasca/doccia serie Tiara con attacco alto da 3-4" ed attacco inferiore da 1/2", con colonna doccia telescopica, doccetta anticalcare a 4 funzioni, con flessibile A505X 150 cm e soffione a pioggia squadrato con angoli arrotondati, in ABS cromato, 20x20 cm, con getti in silicone anticalcare.

Bath/shower mixer Tiara series with upper 3/4" connection and lower connection 1/2", with telescopic shower column, c.p. handshower 4 functions antilimestone, with A505X 150 cm flexible hose and c.p. ABS squared with rounded corners shower head, rain jet, 20x20 cm, with anti-limestone silicon jets.

FUSION

TOKYO

TOKYO
STEEL

DIVA
DEKORA
SENSE

SPEED
DEKORA
SENSE

TIARA

KIT WELLNESS - WELLNESS KIT



TA61420

Set doccia con:

Art. A552CM30 A590 soffione doccia in ottone cromato 20x20 cm, con getti in silicone autopulenti e anticalcare e braccio in ottone cromato cm 30; Art. TA612 miscelatore vasca incasso con deviatore con piastra Tiara; Art. A340 A495 A505 150 saliscendi in ottone cromato con asta minimale e doccetta minimale in ottone cromata ad 1 funzione e flessibile in ottone cromato;

Art. A525 attacco presa acqua da 1/2 tipo rotondo pesante.

Shower set with:

Art. A552CM30 A590 chrome plated brass showerhead Ø20 cm, with silicon selfcleaning antilimestone jets and arm cm 30; Art. TA612 built-in bath/shower mixer with diverter with Tiara Plate; Art. A340 A495 A505 150 c.p. brass minimal sliding rail set with c.p. brass handshower 1 function, and c.p. brass flexible hose; Art. A525 c.p. brass wall connector, round heavy type.



TA61520

Set doccia con:

Art. A552CM30 A590 soffione doccia in ottone cromato 20x20 cm, con getti in silicone autopulenti e anticalcare e braccio in ottone cromato cm 30; Art. TA612 miscelatore vasca incasso con deviatore con piastra Tiara; Art. A495 A546 A505 150 doccetta ad 1 funzione con supporto presa acqua e flessibile in ottone cromato 150 cm.

Shower set with:

Art. A552CM30 A590 chrome plated brass showerhead Ø20 cm, with silicon selfcleaning antilimestone jets and arm cm 30; Art. TA612 built-in bath/shower mixer with diverter with Tiara Plate; Art. A495 A546 A505 150 c.p. brass handshower 1 function with shower holder/water punch and c.p. brass flexible hose 150 cm.

SKYLINE

DEKORA
SENSE

SUVI

DEKORA
SENSE

OXY

DEKORA
SENSE

JAX

KIR

TWIN

DEKORA
SENSE

TIARA



TA614ZB

Set doccia composto da: soffione doccia ultra piatto 33x22 cm in acciaio INOX lucidato a specchio con braccio cm 30, miscelatore vasca/doccia incasso con deviatore con piastra Tiara, saliscendi con asta ovale e doccetta cromata a 4 funzioni con pulsante per il cambio dell'intensità del getto, con getti anticalcare in silicone, attacco presa acqua da 1/2 tipo rotondo pesante.

Shower set composed of: ultra slim stainless steel mirror polished shower head 33x22 cm with arm cm 30, built-in bath/shower mixer with diverter with Tiara Plate, sliding rail set with oval rod and c.p. handshower 4 functions with button to change the intensity of the jet, anti-limestone with silicone jets, brass wall connector, round heavy type.



TA615ZB

Set doccia composto da: soffione doccia ultra piatto 33x22 cm in acciaio INOX lucidato a specchio con braccio in ottone cromato 30 cm, miscelatore vasca/doccia incasso con deviatore con piastra Tiara, doccia a 4 funzioni con pulsante per il cambio dell'intensità del getto, con getti anticalcare in silicone, supporto presa acqua lusso in ottone cromato e flessibile 150 cm.

Shower set composed of: ultra slim stainless steel mirror polished shower head 33x22 cm with c.p. brass arm 30 cm, built-in shower mixer with diverter with Tiara Plate, handshower 4 functions with button to change the intensity of the jet, anti-limestone with silicone jets, c.p. brass shower holder/water punch for built-in, with c.p. brass flexible hose 150 cm.



TA614Z

Set doccia composto da: soffione doccia quadrato con angoli arrotondati ultra piatto cm 20x20, in ABS cromato, con getti in silicone autopulenti e anticalcare e braccio in ottone cromato 30 cm, miscelatore doccia incasso con deviatore con piastra Tiara, saliscendi con asta ovale e doccetta cromata a 4 funzioni con pulsante per il cambio del getto, anticalcare in silicone, attacco presa acqua da 1/2 tipo rotondo pesante.

Shower set composed of: c.p. ABS ultra slim squared shower head with rounded edges cm 20x20, with silicon selfcleaning antilimestone jets and c.p. brass arm 30 cm, built-in shower mixer with diverter with Tiara Plate, sliding rail set with oval rod and c.p. handshower 4 functions with button to change the jets, anti-limestone with silicone jets, brass wall connector, round heavy type.



TA615Z

Set doccia composto da: soffione doccia ultrapiatto in ABS cromato, quadrato con angoli arrotondati cm 20x20, con getti in silicone autopulenti anticalcare e braccio in ottone cromato 30 cm, miscelatore doccia incasso con deviatore con piastra Tiara, doccia a 4 funzioni con pulsante per il cambio dei getti, anticalcare, supporto presa acqua lusso in ottone cromato e flessibile 150 cm.

Shower set composed of: c.p. ABS shower head, squared with rounded edges, ultrathin, 20x20 cm, with silicon selfcleaning antilimestone jets and c.p. brass arm 30 cm, built-in shower mixer with diverter with Tiara Plate, handshower 4 functions with button to change the jets, anti-limestone with silicone jets, c.p. brass shower holder/water punch for built-in, with c.p. brass flexible hose 150 cm.

CUCINA - KITCHEN



TA618

Miscelatore monocomando monoforo 90°, con canna alta a "U".
Altezza: 33,5 cm - Interasse 17,5 cm.
*Single-lever sink mixer 90°, high "U" spout.
Height 33,5 cm - Interaxis 17,5 cm.*



TA618C

Miscelatore monocomando per lavello, con canna corta a "U", tipo lusso.
Altezza: 30 cm - Interasse 12 cm.
*Single-lever one-hole sink mixer, with short "U" spout, luxury type.
Height 30 cm - Interaxis 12 cm.*



TA614B

Miscelatore monocomando per lavello, con bocca alta girevole.
Altezza: 30 cm - Interasse 17 cm.
*Single-lever one-hole sink mixer, with high movable spout.
Height 30 cm - Interaxis 17 cm.*



TA614BC

Miscelatore monocomando per lavello, con canna corta girevole.
Altezza: 26 cm - Interasse 12,5 cm.
*Single-lever one-hole sink mixer, with short "U" spout, luxury type.
Height 26 cm - Interaxis 12,5 cm.*



TA689

Miscelatore monocomando lavello a molla con doccetta estraibile dal supporto ed orientabile a due funzioni e cartuccia Ø 35.
Altezza: 48 cm - Interasse 21,5 cm.
Spring single-lever sink mixer with detachable and adjustable 2-functions hand shower and Ø 35 mm cartridge.
Height 48 cm - Interaxis 21,5 cm.



TA233

Miscelatore lavello monocomando con flessibile nero rivestito con molla "fine design" girevole 360°, con doccetta estraibile di supporto ed orientabile a due funzioni e cartuccia Ø 35.
Altezza: 40,7 cm - Interasse 21 cm.
Single-lever mixer with black flexible hose coated with "fine design" spring, 360° movable, with detachable and adjustable 2-functions hand shower and Ø 35 mm cartridge.
Height 40,7 cm - Interaxis 21 cm.



FUSION

TOKYO

TOKYO
STEEL

DIVA
DEKORA
SENSE

SPEED
DEKORA
SENSE

TIARA

SKYLINE
DEKORA
SENSE

SUVI
DEKORA
SENSE

OXY
DEKORA
SENSE

JAX

KIR

TWIN
DEKORA
SENSE

ACQUA DEPURATA - PURIFIED WATER



TA679DW

Miscelatore lavello a tre vie di ingresso con bocca girevole e due vie d'uscita completamente indipendenti, con selezione acqua potabile tramite la leva.
Altezza: 35,7 cm - Interasse: 17,2 cm.
Three ways inlet single lever sink mixer, with movable spout and two fully independent outlets, with selection for drinking water directly from the lever.
Height: 35,7 cm - Interaxis 17,2 cm.

TOUCH-ME



TAT618

Miscelatore monocomando lavello, monoforo 90° con canna alta ad "U" dotata di tecnologia Touch-Me con leva laterale e bocca girevole. Dotato di cartuccia Ø35.
Altezza: 34 cm - Interasse: 17,5cm.
Single-lever sink mixer 90°, high "U" spout equipped with Touch-Me system with side lever and movable spout. Equipped with Ø35 cartridge.
Height: 34 cm - Interaxis 17,5 cm.



SKYLINE

La Collezione SKYLINE sviluppa un tema di essenzialità nelle linee e di geometrica precisione nelle forme. Una totale robotizzazione del ciclo produttivo assicura inoltre un altissimo livello di qualità ed attenzione al dettaglio.

Design di Cristian Mapelli.

The SKYLINE Collection develops a theme of simplicity in lines and geometric precision of shapes. A full robotization of the production cycle also ensures a high level of quality and attention to detail.

Design By Cristian Mapelli.



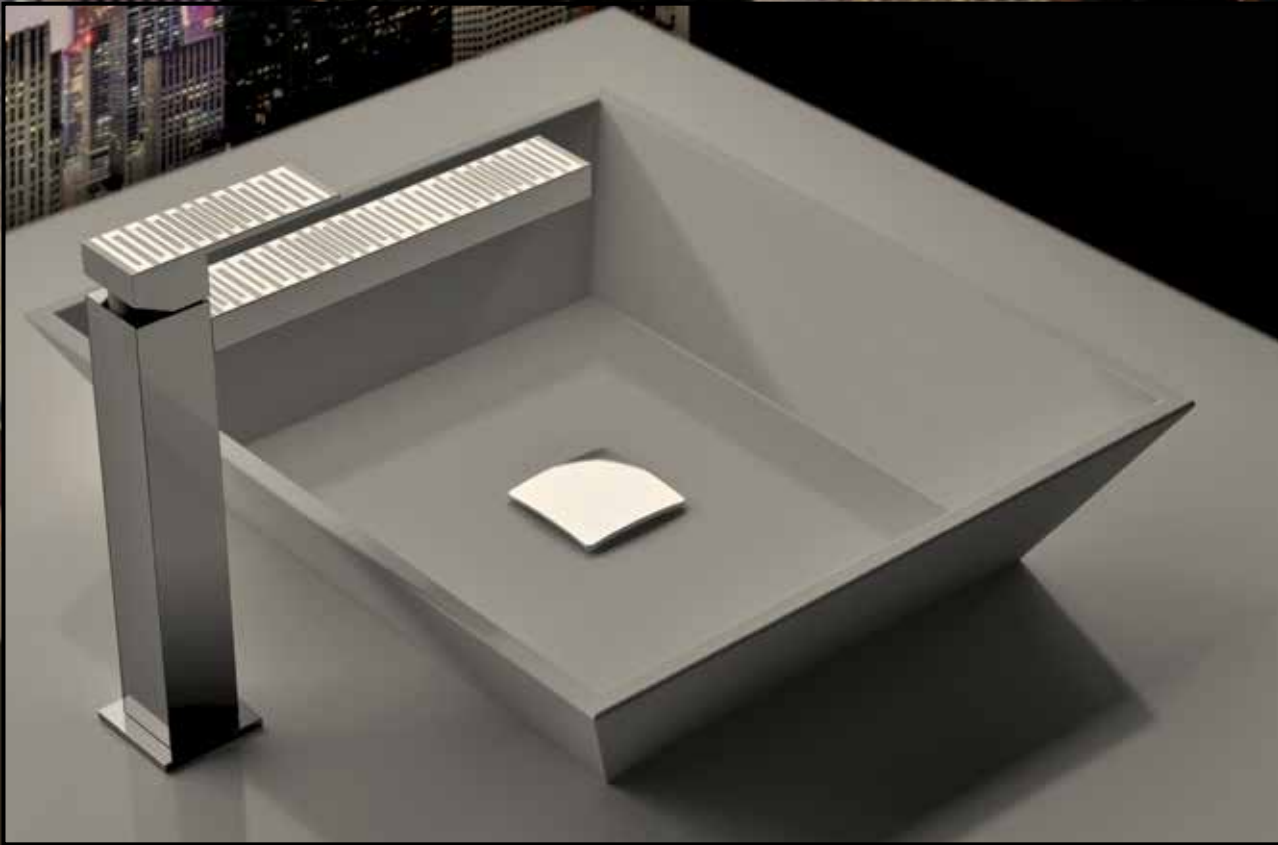

FUSION

TOKYO

TOKYO
STEEL

DIVA
DEKORA
SENSE

SPEED
DEKORA
SENSE

TIARA

SKYLINE

DEKORA
SENSE

SUVI

DEKORA
SENSE

OXY

DEKORA
SENSE

JAX

KIR

TWIN

DEKORA
SENSE

FINISHINGS

FIN 2							
CP cromo spazzolato brushed chrome	NP nichel spazzolato brushed nickel	NPO nichel spazzolato opaco matt brushed nickel	63 vecchio ottone old brass	OIL oil bronze oil bronze			
64 vecchio rame old copper	14 bianco opaco matt white	15 nero opaco matt black					
FIN 4							
DO oro lucido shiny gold	DP oro spazzolato brushed gold	RL rame lucido shiny copper	FZ cromo nero spazzolato lucido shiny brushed black chrome	CF cromo nero lucido shiny black chrome	GO grafite graphite		
FIN 5							
PG oro rosa lucido shiny pink gold	PP oro rosa spazzolato brushed pink gold	RPO rame anodizzato anodised copper					

Finiture consigliate per questa collezione.
Per l'elenco completo fare riferimento alla tabella delle finiture (pag.04)

*Suggested finishes for this collection.
For a complete list of available colors, please refer to the finishing table (page 04)*

DECORI DISPONIBILI:
AVAILABLE DECORATIONS:

OPTICAL **YP**



DECO 1

YP81 cromo lucido, decoro oro spazzolato.
shiny chrome, brushed gold decoration.

DECO 2

YP84 nichel spazzolato, decoro cromo lucido.
brushed nickel, shiny chrome decoration.

YP86 nichel spazzolato, decoro canna di fucile spazzolato.
brushed nickel, brushed gun barrel decoration..

YP97 nichel spazzolato, decoro nichel lucido.
brushed nickel, shiny nickel decoration.

DECO 4

YP85 nichel spazzolato, decoro oro spazzolato.
brushed nickel, brushed gold decoration.

YP95 canna di fucile spazzolato, decoro cromo.
brushed gun barrel, chrome decoration.

YP98 ottone spazzolato decoro ottone lucido.
brushed brass shiny brass decoration.

DECO 5

YP82 oro lucido, decoro oro spazzolato.
shiny gold, brushed gold decoration.

YP83 oro lucido, decoro nichel spazzolato.
shiny gold, brushed nickel decoration.

YP88 oro antico, decoro canna di fucile spazzolato.
antique gold, brushed gun barrel decoration.

YP96 oro spazzolato, decoro cromo.
brushed gold, chrome decoration.

DECO 6

YP14 Bianco Opaco
Matt White

YP15 Nero Opaco
Matt Black

DEKORA

SENSE

SKYLINE

CARATTERISTICHE TECNICHE:

La serie è dotata di cartuccia a dischi ceramici Ø 25 mm, tranne gli incassi che utilizzano la cartuccia a dischi ceramici Ø 35 mm.
 Cartucce prodotte da S.T.S.R. – Studio Tecnico Sviluppo e Ricerche,
 www.stsr.it

TECHNICAL CHARACTERISTICS:

The series is equipped with ceramic cartridge Ø25 mm, except built-in items that use ceramic cartridge Ø35 mm.
 Cartridges are produced by S.T.S.R. - Research Development
 Technical Office, www.stsr.it

LAVABI E BIDET - WASHBASIN AND BIDET MIXERS



Monocomando lavabo
 Altezza: 13,8 cm - Interasse: 15,5 cm
Single-lever basin mixer.
Height: 13,8 cm - Interaxis: 15,5 cm.

SK605

Con scarico.
With pop-up waste.



Monocomando lavabo alto.
 Altezza: 23 cm - Interasse: 18,4 cm
High single-lever basin mixer.
Height: 23 cm - Interaxis: 18,4 cm.

SK607

Con scarico click-clack.
With click-clack waste.

SK606

Senza scarico.
Without waste.

SK607B

Senza scarico.
Without waste.

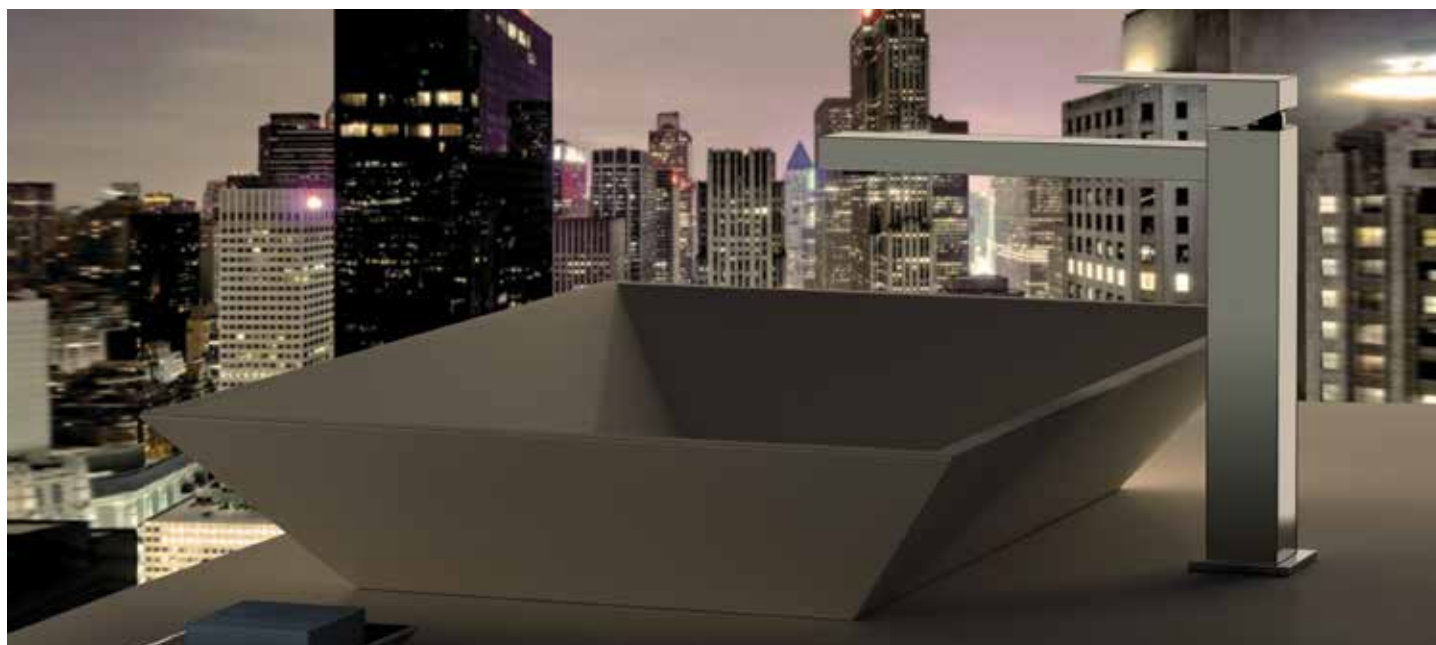

SK607X

Monocomando lavabo alto XL con scarico
 click-clack.
 Altezza: 27,5 cm - Interasse: 18,4 cm
High XL basin mixer with click-clack
waste.
Height: 27,5 cm - Interaxis: 18,4 cm.



SK607XL

Monocomando lavabo alto XXL con
 scarico click-clack.
 Altezza: 32,8 cm - Interasse: 18,4 cm
High XXL basin mixer with click-clack
waste.
Height: 32,8 cm - Interaxis: 18,4 cm.



SK655

Miscelatore monocomando lavabo due fori.
Altezza: 16,5 cm - Interasse: 15,1 cm
Two holes single-lever washbasin mixer.
Height: 16,5 cm - Interaxis: 15,1 cm.



SK605R

Miscelatore monocomando per lavabo con
canna corta a "U" girevole e scarico click-clack.
Altezza: 28 cm - Interasse: 15,5 cm
Single-lever one-hole sink mixer with short
"U" movable spout and click-clack waste.
Height: 28 cm - Interaxis: 15,5 cm.



SK688

Miscelatore monocomando lavabo da
pavimento con click-clack e troppo pieno.
Altezza bocca: 94 cm - Interasse: 17 cm
Single-lever mixer floor mounting with
click-clack and overflow.
Height spout: 94 cm - Interaxis: 17 cm.



SK605RL

Miscelatore monocomando alto per lavabo con
canna corta a "U" girevole e scarico click-clack.
Altezza: 33 cm - Interasse: 15,5 cm
High single-lever one-hole sink mixer with short
"U" movable spout and click-clack waste.
Height: 33 cm - Interaxis: 15,5 cm.



SK605RXL

Miscelatore monocomando alto per lavabo con
canna lunga "U" girevole e scarico click-clack.
Altezza: 41 cm - Interasse: 22 cm
High single-lever one-hole sink mixer with long
"U" movable spout and click-clack waste.
Height: 41 cm - Interaxis: 22 cm.



SK622

Miscelatore lavabo da incasso.
Lunghezza bocca: 20 cm.
Concealed Washbasin mixer.
Length spout: 20 cm.



SK632P

Miscelatore lavabo da incasso.
Lunghezza bocca: 20 cm.
Concealed Washbasin mixer.
Length spout: 20 cm.

FUSION

TOKYO

TOKYO
STEEL

DIVA
DEKORA
SENSE

SPEED
DEKORA
SENSE

TIARA

SKYLINE
DEKORA
SENSE

SUVI
DEKORA
SENSE

OXY
DEKORA
SENSE

JAX

KIR

TWIN
DEKORA
SENSE



SK632

Miscelatore monocomando a incasso per lavabo, con piastra rettangolare. Lunghezza bocca 20 cm.
Single-lever built-in basin mixer, with rectangular wall flange. Length spout 20 cm.



SK634

Miscelatore monocomando a incasso per lavabo, con piastra verticale rettangolare. Lunghezza bocca 20 cm.
Single lever built-in basin mixer, with vertical rectangular wall flange. Length spout 20 cm.

LAVABO BOX INCASSO - BUILT-IN BOX WASHBASIN MIXER



SK632KB

Miscelatore monocomando a incasso per lavabo, con piastra in ottone cromato, bocca lunghezza 20 cm, da abbinare al box incasso.
Single-lever built-in basin mixer, with wall flange in chrome plated brass, spout length 20 cm, to match with the built-in box.

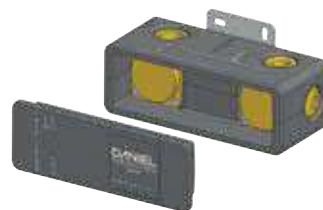

DAN BOX632

Box da incasso per miscelatore monocomando a incasso per lavabo.
Built-in box for single-lever built-in basin mixer.

BIDET



SK604

Miscelatore bidet.
 Altezza: 11,6 cm - Interasse: 12,6 cm
Bidet mixer. Height: 11,6 cm - Interaxis: 12,6 cm.

Con scarico.
With pop-up waste.

SK604B

Senza scarico.
Without waste.



SK605SH

Miscelatore monocomando lavabo con doccia shut-off e scarico click-clack con troppo pieno.
Single-lever basin mixer with shut-off handshower and click-clack pop-up waste with overflow.



SK642

Miscelatore incasso per shut-off con doccia shut-off, supporto doccia, presa acqua.
Built-in shut-off mixer set with shut-off, shower holder, water punch.



SK646

Miscelatore incasso per shut-off.
Built-in shut-off mixer.

MISCELATORI VASCA E DOCCIA - SHOWER AND BATH MIXERS



Miscelatore vasca esterno.
Exposed bath mixer.

SK610 con kit doccia, flessibile 150 cm.
with shower kit, flexible 150 cm.

SK600 con kit doccia, flessibile 120 cm.
with shower kit, flexible 120 cm.

SK600H senza kit doccia.
without shower kit.

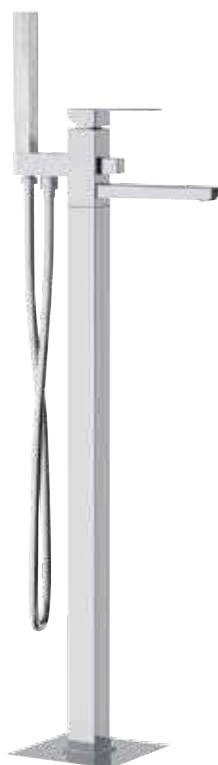

SK678

Miscelatore vasca da pavimento con deviatore e kit doccia.

Altezza bocca: 78 cm - Interasse: 22,3 cm.
Free standing bath mixer floor mounting with diverter and shower kit
Height spout: 78 cm - Interaxis: 22,3 cm.



SK652

Miscelatore monocomando per vasca da incasso, su piastra in ottone cromato.
Single-lever bath mixer, with wall flange in chrome plated.



SK691

Miscelatore monocomando bordo vasca.
Single lever deck bath/shower mixer.

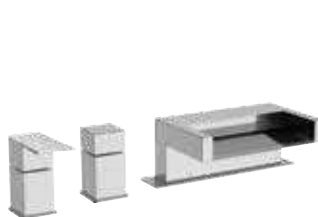

SK697

Miscelatore monocomando bordo vasca.
Single lever deck bath/shower mixer.

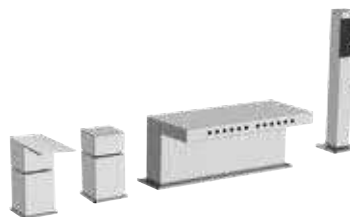

SK699

Miscelatore monocomando bordo vasca.
Single lever deck bath/shower mixer.

FUSION

TOKYO

TOKYO
STEEL

DIVA
DEKORA
SENSE

SPEED
DEKORA
SENSE

TIARA

SKYLINE

DEKORA
SENSE

SUVI

DEKORA
SENSE

OXY

DEKORA
SENSE

JAX

KIR

TWIN

DEKORA
SENSE

SKYLINE



SK606D

Miscelatore monoforo lavabo/vasca, con deviatore e kit doccia.
Single lever one-hole sink/bath mixer with diverter and shower set.



Monocomando doccia esterno.
Exposed shower mixer.

SK611A

con kit doccia.
with shower kit.

SK611

senza kit doccia.
without shower kit.



A345 495

Saliscendi completamente in ottone cromato quadro con doccetta ad 1 funzione.
 Altezza: 70 cm.
C.p. brass square sliding rail set with 1 function handshower.
 Height: 70 cm,



SK611Z

Monocomando doccia esterno con attacco 3/4 M per colonna.
Exposed shower mixer with connection 3/4 M for columns.



BOCCHIE - SPOUTS



SK4704
Bocca incasso 18 cm.
Built-in spout 18 cm.



SK4702
Bocca incasso con deviatore integrato
18 cm.
Built-in spout with diverter 18 cm.



C4705Q
Bocca bordo vasca a cascata.
Waterfall built-in spout.



F4705Q
Bocca bordo vasca con effetto
multigetto.
*Spout with multijet effect for deck bath/
shower mixer.*



CA4704
Bocca incasso a cascata.
Built-in spout with waterfall jet.



A740
Sifone squadrato in ottone
cromato 1"1/4.
*C.P. brass "Square" P trap
1"1/4.*

A590CA
Soffione doccia con getto a cascata.
C.p. Brass shower head with waterfall jet.

FUSION

TOKYO

TOKYO
STEEL

DIVA
DEKORA
SENSE

SPEED
DEKORA
SENSE

TIARA

SKYLINE
DEKORA
SENSE

SUVI
DEKORA
SENSE

OXY
DEKORA
SENSE

JAX

KIR

TWIN
DEKORA
SENSE

INCASSI DOCCIA - BUILT-IN MIXERS



SK602
Miscelatore doccia incasso.
Single-lever built-in shower mixer.



SK602B
Miscelatore doccia incasso.
Built-in shower mixer.

IN602C35 Parte interna miscelatore monocomando incasso doccia.
Single-lever shower mixer (built-in components).

IN602C35 Parte interna miscelatore monocomando incasso doccia.
Single-lever shower mixer (built-in components).

SK602EKIT Parte esterna miscelatore monocomando incasso doccia.
Single-lever shower mixer (external components).

SK602BEKIT Parte esterna miscelatore monocomando incasso doccia.
Single-lever shower mixer (external components).

INCASSI DOCCIA - BUILT-IN MIXERS



SK612

Miscelatore vasca incasso con deviatore.
Built-in bath/shower mixer with diverter.



SK612B

Miscelatore vasca incasso con deviatore.
Built-in bath/shower mixer with diverter.

IN612C35

Parte interna miscelatore monocomando incasso vasca/doccia con deviatore.
Single-lever bath/shower mixer with diverter (built-in components).

IN612C35

Parte interna miscelatore monocomando incasso vasca/doccia con deviatore.
Single-lever bath/shower mixer with diverter (built-in components).

SK612EKIT

Parte esterna miscelatore monocomando incasso vasca/doccia con deviatore.
Single-lever bath/shower mixer with diverter (external components).

SK612BEKIT

Parte esterna miscelatore monocomando incasso vasca/doccia con deviatore.
Single-lever bath/shower mixer with diverter (external components).



SK612D2

Miscelatore monocomando per doccia con deviatore a 2 posizioni su piastra unica.
Single-lever shower mixer, with 2 positions diverter on single flange.



SK612D3

Miscelatore monocomando per doccia con deviatore a 3 vie e 3 posizioni (una entrata e tre uscite) su unica piastra.
Single lever built-in shower mixer with 3 ways diverter and 3 positions (1 inlet and 3 outlets) on single flange.



SK612D7

Miscelatore monocomando per doccia con deviatore a tre vie e sette posizioni su unica piastra.
Single lever built-in shower mixer with three ways diverter with seven positions on single flange.



SK612D5

Miscelatore monocomando per doccia, con deviatore a 5 vie (5 uscite ed una entrata) su piastra singola.
Single-lever shower mixer with 5 ways diverter (5 outlets and 1 inlet) on single flange.



SK612D4

Miscelatore monocomando per doccia con deviatore a quattro vie (4 uscite ed 1 entrata) su piastra unica.
Single lever built-in shower mixer with four ways diverter (4 outlets and 1 inlet) on single flange.

BOX INCASSO - BUILT-IN BOX

SK602KB

Set miscelatore doccia da abbinare al box incasso.
Shower mixer set to match with the built-in box.



+



DAN BOX

Box da incasso per miscelatore doccia con deviatore.
Built-in box for shower mixer with diverter.

FUSION

TOKYO

SK612KB

Set miscelatore doccia con deviatore da abbinare al box incasso.
Shower mixer set with diverter to match with the built-in box.



+



DAN BOX

Box da incasso per miscelatore doccia con deviatore.
Built-in box for shower mixer with diverter.

TOKYO

STEEL

DIVA

DEKORA
SENSE

SK612D2KB

Set miscelatore doccia due vie da abbinare al box incasso.
Two ways shower mixer set to match with the built-in box.



+



DAN BOXD2

Box da incasso per miscelatore doccia due vie.
Built-in box for two ways shower mixer.

SPEED

DEKORA
SENSE

TIARA

SK612D3KB

Set miscelatore doccia tre vie da abbinare al box incasso.
Three ways shower mixer set to match with the built-in box.



+



DAN BOXD3

Box da incasso per miscelatore doccia tre vie.
Built-in box for three ways shower mixer.

SKYLINE

DEKORA
SENSE

SUVI

DEKORA
SENSE

OXY

DEKORA
SENSE

SK612D7KB

Set miscelatore doccia tre vie e sette posizioni da abbinare al box incasso.
Three ways and seven positions shower mixer set to match with the built-in box.



+



DAN BOXD3

Box da incasso per miscelatore doccia tre vie.
Built-in box for three ways shower mixer.

JAX

KIR

TWIN

DEKORA
SENSE

COLONNE DOCCIA - SHOWER COLUMN



SK6370

Corpo doccia con colonna e soffione tutto in ottone cromato.
Exposed shower mixer with shower column and shower head all in brass.



SK6360

Corpo doccia con colonna, doccetta ad 1 funzione e soffione tutto in ottone cromato.
Exposed shower mixer with shower column, 1 function handshower and shower head all in brass.

WELLNESS



Set doccia con soffione doccia ultra piatto in acciaio INOX lucidato a specchio, con braccio doccia in ottone cromato 30 cm, saliscendi e doccetta ad 1 funzione con flessibile 150 cm tutto in ottone cromati, presa acqua lusso quadrata, miscelatore incasso con deviatore a tre vie e sette posizioni su piastra unica, 6 getti anticalcare in ottone cromato.

Shower kit with ultra slim stainless steel mirror polished shower head with C.P. brass shower arm 30 cm, deluxe sliding rail with hand shower 1 function all in c.p. brass with flexible hose 150 cm, luxury water punch, built-in mixer with three ways diverter with seven positions on single flange and 6 jets anti-limestone in c.p. brass.

SK613Z7920

Disponibile con soffione da cm 20x20 cm e braccio da 30 cm.
Available with head shower cm 20x20 cm and arm 30 cm.

SK613Z7925

Disponibile con soffione da cm 25x25 cm e braccio da 30 cm.
Available with head shower cm 25x25 cm and arm 30 cm.

SK613Z7930

Disponibile con soffione da cm 30x30 cm e braccio da 30 cm.
Available with head shower cm 30x30 cm and arm 30 cm.

SK613Z7940

Disponibile con soffione da cm 40x40 cm e braccio da 40 cm.
Available with head shower cm 40x40 cm and arm 40 cm.

SK613S7920

Disponibile con soffione da cm 20x20 cm e braccio a soffitto da 30 cm.
Available with head shower cm 20x20 cm and ceiling arm 30 cm.



Set doccia con soffione doccia ultra piatto in acciaio INOX lucidato a specchio e braccio doccia in ottone cromato 30 cm, supporto doccia deluxe presa acqua deluxe, doccetta in ottone cromato ad 1 funzione e flessibile conico in ottone cromato 150 cm, miscelatore incasso con deviatore a tre vie e sette posizioni su piastra unica, 6 getti anticalcare in ottone cromato.

Shower kit with ultra slim stainless steel mirror polished shower head with C.P. brass shower arm 30 cm, c.p. brass deluxe shower holder/water punch, c.p. brass hand shower 1 function with shower flexible hose in brass 150 cm, built-in mixer with three ways seven positions with diverter on single flange and 6 jets anti-limestone in c.p. brass.

SK616Z7920

Disponibile con soffione da cm 20x20 cm e braccio da 30 cm.
Available with head shower cm 20x20 cm and arm 30 cm.

SK616Z7925

Disponibile con soffione da cm 25x25 cm e braccio da 30 cm.
Available with head shower cm 25x25 cm and arm 30 cm.

SK616Z7930

Disponibile con soffione da cm 30x30 cm e braccio da 30 cm.
Available with head shower cm 30x30 cm and arm 30 cm.

SK616Z7940

Disponibile con soffione da cm 40x40 cm e braccio da 40 cm.
Available with head shower cm 40x40 cm and arm 40 cm.

SK616S7920

Disponibile con soffione da cm 20x20 cm e braccio a soffitto da 30 cm.
Available with head shower cm 20x20 cm and ceiling arm 30 cm.

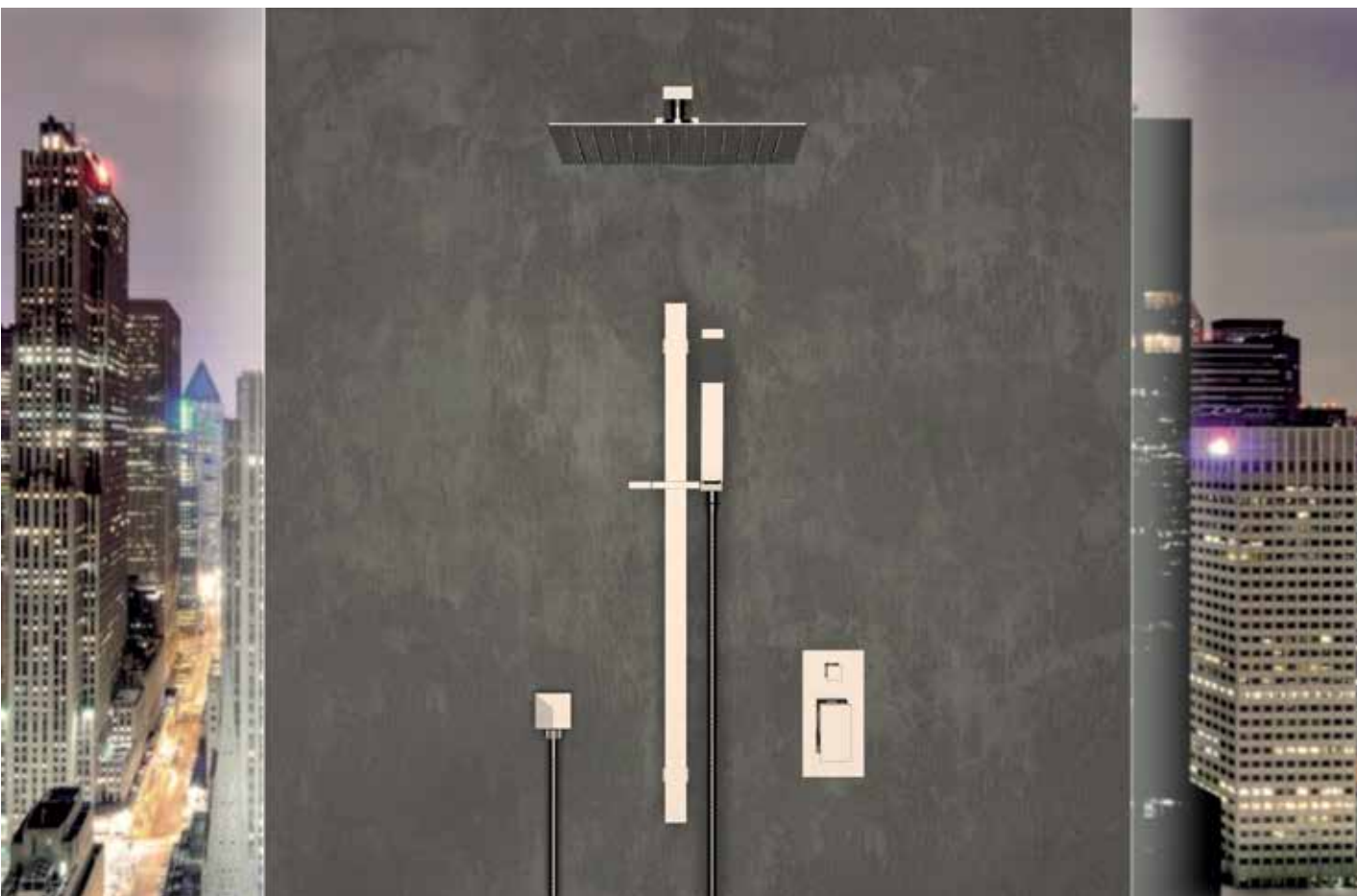

FUSION

TOKYO

TOKYO
STEEL

DIVA
DEKORA
SENSE

SPEED
DEKORA
SENSE

TIARA

SKYLINE

DEKORA
SENSE

SUVI

DEKORA
SENSE

OXY

DEKORA
SENSE

JAX

KIR

TWIN

DEKORA
SENSE



Set doccia con soffione doccia ultra piatto in acciaio INOX lucidato a specchio, con braccio doccia in ottone cromato 30 cm, saliscendi e doccetta ad 1 funzione tutto in ottone cromato e flessibile 150 cm, presa acqua lusso quadrata, miscelatore incasso con deviatore.
Shower kit with ultra slim stainless steel mirror polished shower head with C.P. brass shower arm 30 cm, deluxe sliding rail with hand shower 1 function all in c.p. brass and flexible hose 150 cm, luxury water punch and built-in mixer with diverter.

SK614Z7920

Disponibile con soffione da cm 20x20 cm e braccio da 30 cm.
Available with head shower cm 20x20 cm and arm 30 cm.

SK614Z7925

Disponibile con soffione da cm 25x25 cm e braccio da 30 cm.
Available with head shower cm 25x25 cm and arm 30 cm.

SK614Z7930

Disponibile con soffione da cm 30x30 cm e braccio da 30 cm.
Available with head shower cm 30x30 cm and arm 30 cm.

SK614Z7940

Disponibile con soffione da cm 40x40 cm e braccio da 40 cm.
Available with head shower cm 40x40 cm and arm 40 cm.

SK614S7920

Disponibile con soffione da cm 20x20 cm e braccio a soffitto da 30 cm.
Available with head shower cm 20x20 cm and ceiling arm 30 cm.



Set doccia con soffione doccia ultra piatto in acciaio INOX lucidato a specchio, con braccio doccia in ottone cromato 30 cm, supporto doccia/presa acqua deluxe, doccetta ad 1 funzione e flessibile conico tutto in ottone cromato 150 cm, miscelatore incasso con deviatore.
Shower kit with ultra slim stainless steel mirror polished shower head with C.P. brass shower arm 30 cm, deluxe shower holder/water punch with hand shower 1 function all in c.p. brass and shower flexible hose in brass 150 cm, built-in mixer with diverter.

SK615Z7920

Disponibile con soffione da cm 20x20 cm e braccio da 30 cm.
Available with head shower cm 20x20 cm and arm 30 cm.

SK615Z7925

Disponibile con soffione da cm 25x25 cm e braccio da 30 cm.
Available with head shower cm 25x25 cm and arm 30 cm.

SK615Z7930

Disponibile con soffione da cm 30x30 cm e braccio da 30 cm.
Available with head shower cm 30x30 cm and arm 30 cm.

SK615Z7940

Disponibile con soffione da cm 40x40 cm e braccio da 40 cm.
Available with head shower cm 40x40 cm and arm 40 cm.

SK615S7920

Disponibile con soffione da cm 20x20 cm e braccio a soffitto da 30 cm.
Available with head shower cm 20x20 cm and ceiling arm 30 cm.



SK615Z

Set doccia con soffione a pioggia rettangolare 24x14 cm con getti in silicone anticalcare e braccio 30 cm, doccetta ad 1 funzione con supporto/presa acqua snodato lusso quadrato, miscelatore incasso con deviatore. Tutto in ottone cromato.
Shower kit with rectangular shower head 24x14 cm with rain jet antilimestone and arm 30 cm, hand shower 1 function with shower holder/water punch connector squared, Built-in bath /shower mixer with diverter. All in c.p. brass.



SK614ZC

Set doccia con soffione doccia a cascata, saliscendi lusso con doccetta ad 1 funzione, attacco presa acqua tipo quadrato pesante, miscelatore incasso con deviatore. Tutto in ottone cromato.
Shower kit with c.p. brass shower head with waterfall jet, deluxe sliding rail with hand shower 1 function, wall water punch connector, squared and heavy type, built-in bath /shower mixer with diverter. All in c.p. brass.



SK616Z

Set doccia con soffione a pioggia rettangolare 24x14 cm con getti in silicone anticalcare e braccio 30 cm, doccetta ad 1 funzione con supporto/presa acqua snodato lusso quadrato, miscelatore e deviatore 3 vie e 7 posizioni, 6 getti anticalcare. Tutto in ottone cromato.
Shower kit with rectangular shower head 24x14 cm with rain jet antilimestone and arm 30 cm, hand shower 1 function with shower holder/water punch connector squared, shower mixer with 3 ways diverter and 7 positions, 6 jets anti limestone. All in c.p. brass



SK617Z

Set doccia con soffione a pioggia rettangolare 24x14 cm con getti in silicone anticalcare e braccio 30 cm, doccetta ad 1 funzione con supporto/presa acqua snodato lusso quadrato, miscelatore e deviatore 3 vie e 7 posizioni, bocca incasso per miscelatore vasca-doccia. Tutto in ottone cromato.
Shower kit with rectangular shower head 24x14 cm with rain jet with antilimestone and arm 30 cm, hand shower 1 function with shower holder/water punch connector squared, shower mixer with 3 ways diverter and 7 positions, built-in spout. All in c.p. brass.



SK613Z

Set doccia con soffione a pioggia rettangolare 24x14 cm con getti anticalcare e braccio 30 cm, saliscendi lusso con doccetta ad 1 funzione, attacco presa acqua tipo quadrato pesante, miscelatore e deviatore 3 vie e 7 posizioni e 6 getti anticalcare. Tutto in ottone cromato.
Shower kit with rectangular shower head 24x14 cm with rain jet with antilimestone and arm 30 cm, deluxe sliding rail with hand shower 1 function, wall water punch connector, squared and heavy type, shower mixer with 3 ways diverter and 7 positions and 6 jets anti limestone. All in c.p. brass.



SK614Z

Set doccia con soffione a pioggia rettangolare 24x14 cm con getti anticalcare e braccio 30 cm, saliscendi lusso con doccetta ad 1 funzione, attacco presa acqua tipo quadrato pesante, miscelatore incasso con deviatore. Tutto in ottone cromato.
Shower kit with rectangular shower head 24x14 cm with rain jet with antilimestone and arm 30 cm, deluxe sliding rail with hand shower 1 function, wall water punch connector, squared and heavy type, built-in bath/shower mixer with diverter. All in c.p. brass.



Set doccia con soffione a parete in acciaio INOX lucidato a specchio, saliscendi con doccetta ad 1 funzione tutto in ottone cromato, flessibile conico in ottone cromato 150 cm, presa acqua lusso quadrata, miscelatore monocomando per doccia 6 getti anticalcare in ottone cromato.

Shower set with stainless steel mirror polished wall shower head, deluxe sliding rail with hand shower 1 function all in c.p. brass, shower flexible hose in brass cm 150, luxury water punch, single lever built-in shower mixer 6 jets anti-limestone in c.p. brass.

SK613ZSSCA

Disponibile con soffione a 2 getti, pioggia e cascata art. A562CA e miscelatore monocomando per doccia con deviatore a 4 vie su piastra unica SK612D4.

Available with 2 jets shower head, rain and waterfall and art. A562CA and single lever built-in shower mixer with 4 ways diverter on single flange SK612D4.

SK613ZSS

Disponibile con soffione A562 senza cascata.

Available with head shower A562 without waterfall jet.



Set doccia con soffione a parete in acciaio INOX lucidato a specchio, supporto doccia presa acqua deluxe, con doccetta in ottone cromato ad 1 funzione e flessibile conico in ottone cromato 150 cm, miscelatore monocomando per doccia, 6 getti anticalcare in ottone cromato.

Shower set with stainless steel mirror polished wall shower head, shower holder/water punch deluxe in c.p. brass, with c.p. brass hand shower 1 function, shower flexible hose in brass 150 cm, luxury water punch, single lever built-in shower mixer, 6 jets anti-limestone in c.p. brass.

SK616ZSSCA

Disponibile con soffione a 2 getti, pioggia e cascata art. A562CA e miscelatore monocomando per doccia con deviatore a 4 vie su piastra unica SK612D4.

Available with 2 jets shower head, rain and waterfall and art. A562CA and single lever built-in shower mixer with 4 ways diverter on single flange SK612D4.

SK616ZSS

Disponibile con soffione A562 senza cascata.

Available with head shower A562 without waterfall jet.



Set doccia con soffione doccia a parete in acciaio INOX lucidato a specchio, saliscendi con doccetta ad 1 funzione tutto in ottone cromato, flessibile conico in ottone cromato cm 150, presa acqua lusso quadrata in ottone cromato, miscelatore monocomando per doccia.

Shower set with stainless steel mirror polished wall shower head, deluxe sliding rail with hand shower 1 function, all in c.p. brass, shower flexible hose in brass cm 150, luxury c.p. brass water punch, single lever built-in shower mixer.

SK614ZSSCA

Disponibile con soffione a 2 getti, pioggia e cascata art. A562CA e miscelatore monocomando per doccia con deviatore a tre vie e 7 uscite su piastra unica SK612D7.

Available with 2 jets shower head, rain and waterfall and art. A562CA and single lever built-in shower mixer with three ways and 7 positions diverter on single flange SK612D7.

SK614ZSS

Disponibile con soffione A562 senza cascata, e miscelatore incasso con deviatore SK612.

Available with head shower A562 without waterfall jet and built-in mixer with diverter SK612.



Set doccia con soffione doccia a parete in acciaio INOX lucidato a specchio, supporto doccia presa acqua deluxe in ottone cromato, con doccetta ad 1 funzione in ottone cromato e flessibile conico in ottone cromato 150 cm, miscelatore monocomando per doccia.

Shower set with stainless steel mirror polished wall shower head, deluxe shower holder/water punch in c.p. brass, with c.p. brass hand shower 1 function with shower flexible hose in brass 150 cm, luxury water punch, single lever built-in shower mixer.

SK615ZSSCA

Disponibile con soffione a 2 getti, pioggia e cascata art. A562CA e miscelatore monocomando per doccia con deviatore a tre vie e 7 uscite su piastra unica SK612D7.

Available with 2 jets shower head, rain and waterfall and art. A562CA and single lever built-in shower mixer with three ways and 7 positions diverter on single flange SK612D7.

SK615ZSS

Disponibile con soffione A562 senza cascata, e miscelatore incasso con deviatore SK612.

Available with head shower A562 without waterfall jet and built-in mixer with diverter SK612.

FUSION

TOKYO

TOKYO
STEEL

DIVA

DEKORA
SENSE

SPEED

DEKORA
SENSE

TIARA

SKYLINE

DEKORA
SENSE

SUVI

DEKORA
SENSE

OXY

DEKORA
SENSE

JAX

KIR

TWIN

DEKORA
SENSE

CUCINA - KITCHEN



SK608

Monocomando lavello completamente girevole.
 Altezza: 23,5 cm - Interasse: 20,5 cm.
*Single-lever Sink mixer completely swivelling.
 Height: 23,5 cm - Interaxis: 20,5 cm.*



SK617

Miscelatore monocomando per lavello, con bocca alta a "U" girevole.
 Altezza: 31 cm - Interasse: 22 cm.
*Single-lever one-hole sink mixer, with high "U" movable spout.
 Height: 31 cm - Interaxis: 22 cm.*



KC2201

Monocomando lavello bocca girevole, corpo quadrato.
 Altezza: 25 cm - Interasse: 20 cm.
*Single lever sink mixer swivelling spout, squared body.
 Height: 25 cm - Interaxis: 20 cm.*



SK609

Miscelatore lavello a muro con canna girevole.
 Lunghezza canna: 20 cm.
*Wall mounted single lever sink mixer with movable spout.
 Length spout: 20 cm.*

ACQUA DEPURATA - PURIFIED WATER



TEMT608QDW

Miscelatore lavello Quadrato a tre vie di ingresso con bocca girevole, con selezione acqua potabile tramite pulsante ad azionamento piezoelettrico alimentato a batteria, con 2 aeratori in uscita.
 Altezza: 29,5 cm - Interasse: 21,5 cm.
*Three ways inlet squared single lever sink mixer, with movable spout, with selection for drinking water with piezoelectric activation button, with 2 exit aerators.
 Height: 29,5 cm - Interaxis: 21,5 cm.*



SK608DW

Miscelatore lavello Quadrato a tre vie di ingresso con bocca girevole, con selezione acqua potabile tramite la leva, con 2 aeratori indipendenti in uscita.
 Altezza: 31,6 cm - Interasse: 21,7 cm.
*Three ways inlet squared single lever sink mixer, with movable spout, with selection for drinking water directly from the lever, with 2 independent exit aerators.
 Height: 31,6 cm - Interaxis: 21,7 cm.*



FUSION

TOKYO

TOKYO
STEEL

DIVA
DEKORA
SENSE

SPEED
DEKORA
SENSE

TIARA

SKYLINE
DEKORA
SENSE

TOUCH-ME



SKT617

Miscelatore monocomando per lavello, con bocca alta a "U" girevole dotato di tecnologia touch-me.
Altezza: 31,5 cm - Interasse: 22 cm.
*Single-lever one-hole sink mixer, with high "U" movable spout and equipped with touch-me technology.
Height: 31,5 cm - Interaxis: 22 cm.*

SUVI
DEKORA
SENSE

OXY
DEKORA
SENSE

JAX

KIR

TWIN
DEKORA
SENSE



SUVI

La collezione SUVI segue le logiche di un minimalismo classico che riduce le forme all'indispensabile per lasciare spazio alla purezza delle linee. Un design dai contorni tondeggianti, curato e riprodotto con estrema precisione grazie ad una totale robotizzazione del ciclo produttivo.

SUVI collection follows the logic of classic minimalism, reducing shapes to essential in order to give space to purity of the lines. A round-edged design, edited and reproduced very accurately thanks to a total robotization of the production cycle.





FUSION

TOKYO

TOKYO
STEEL

DIVA
DEKORA
SENSE

SPEED
DEKORA
SENSE

TIARA

SKYLINE

DEKORA
SENSE

SUVI

DEKORA
SENSE

OXY

DEKORA
SENSE

JAX

KIR

TWIN

DEKORA
SENSE

FINISHINGS

FIN 2			
CP cromo spazzolato brushed chrome	NP nichel spazzolato brushed nickel	NPO nichel spazzolato opaco matt brushed nickel	63 vecchio ottone old brass
64 vecchio rame old copper	14 bianco opaco matt white	15 nero opaco matt black	OIL oil bronze oil bronze
FIN 4			
DO oro lucido shiny gold	DP oro spazzolato brushed gold	RL rame lucido shiny copper	FZ cromo nero spazzolato lucido shiny brushed black chrome
FIN 5		CF cromo nero lucido shiny black chrome	GO grafite graphite
PG oro rosa lucido shiny pink gold	PP oro rosa spazzolato brushed pink gold	RPO rame anodizzato anodised copper	

Finiture consigliate per questa collezione.
Per l'elenco completo fare riferimento alla tabella delle finiture (pag.04)

*Suggested finishes for this collection.
For a complete list of available colors, please refer to the finishing table (page 04)*

DECORI DISPONIBILI:
AVAILABLE DECORATIONS:

SPIRAL YC



DEKORA
SENSE

DECO 2		DECO 3	
YC86 nichel spazzolato, decoro canna di fucile spazzolato. brushed nickel, brushed gun barrel decoration..	YC97 nichel spazzolato, decoro nichel lucido. brushed nickel, shiny nickel decoration,	YC90 vecchio ottone decoro oro lucido. old brass shiny gold decoration.	
DECO 4		DECO 5	
YC85 nichel spazzolato, decoro oro spazzolato. brushed nickel, brushed gold decoration.	YC95 canna di fucile spazzolato, decoro cromo. brushed gun barrel, chrome decoration.	YC98 ottone spazzolato decoro ottone lucido. brushed brass shiny brass decoration.	
YC88 oro antico, decoro canna di fucile spazzolato. antique gold, brushed gun barrel decoration.	YC96 oro spazzolato, decoro cromo. brushed gold, chrome decoration.		
DECO 6			
YC14 Bianco Opaco Matt White	YC15 Nero Opaco Matt Black		

CARATTERISTICHE TECNICHE:

La serie è dotata di cartuccia a dischi ceramici, Ø 35 mm, prodotta da S.T.S.R. Studio Tecnico Sviluppo e Ricerche www.stsr.it

TECHNICAL CHARACTERISTICS:

The series is equipped with ceramic cartridge, Ø 35 mm, produced by S.T.S.R. - Research Development Technical Office www.stsr.it

LAVABI - WASHBASIN MIXERS



S20605

Monocomando lavabo
Altezza: 17 cm - Interasse: 10,5 cm
Single-lever basin mixer.
Height: 17 cm - Interaxis: 10,5 cm.

Con scarico.
With pop-up waste.

S20606

Senza scarico e senza foro.
Without waste and body hole.



S20688

Miscelatore monocomando lavabo da pavimento con click-clack e troppo pieno.

Altezza bocca: 95 cm - Interasse: 22 cm
Single-lever mixer floor mounting with click-clack and overflow.
Height spout: 95 cm - Interaxis: 22 cm.

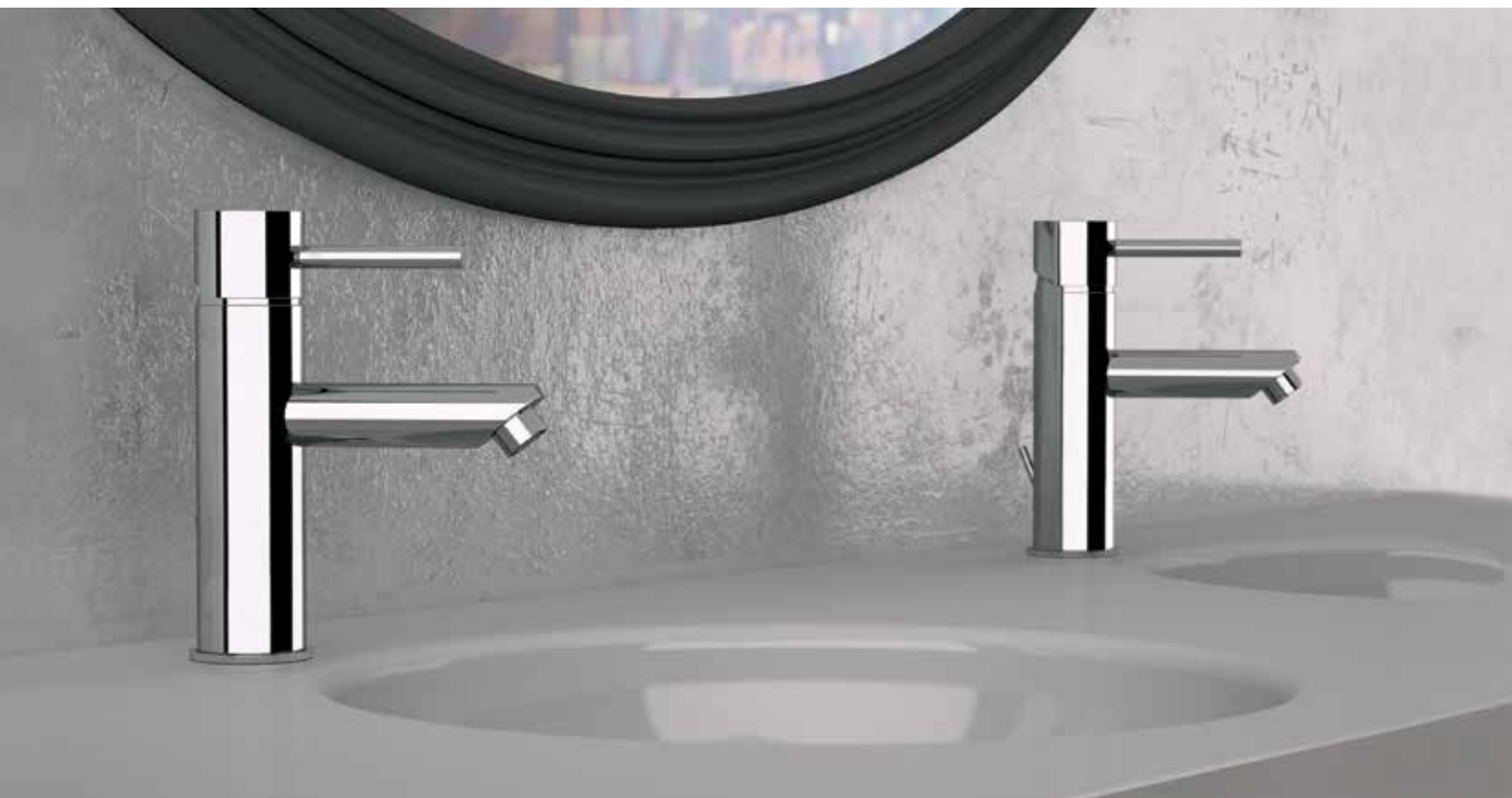



Monocomando lavabo alto.
Altezza: 26,5 cm - Interasse: 10,5 cm
High basin mixer.
Height: 26,5 cm - Interaxis: 10,5 cm.

S20607

Con scarico click-clack.
With click-clack waste.

S20607B

Senza scarico.
Without waste.



Monocomando lavabo alto.
Altezza: 29,5 cm - Interasse: 17 cm
High basin mixer.
Height: 29,5 cm - Interaxis: 17 cm.

S20607X

Con scarico click-clack.
With click-clack waste.

S20607XB

Senza scarico.
Without waste.



S20632

Miscelatore monocomando a incasso per lavabo, con piastra rettangolare.
Lunghezza bocca: 18 cm.
Single-lever built-in basin mixer, with rectangular wall flange.
Spout length: 18 cm.



S20634

Miscelatore monocomando a incasso per lavabo, con piastra rettangolare verticale.
Lunghezza bocca: 18 cm.
Single-lever built-in basin mixer, with vertical rectangular wall flange.
Spout length: 18 cm.



Miscelatore da soffitto in ottone cromato, con miscelazione e controllo flusso integrati nella bocca di erogazione.
Ceiling mixer in chrome plated brass, with mixing and flow control integrated in the outlet spout.

SL20703

lunghezza 166 cm e dispositivo color.
length 166 cm and colour device.

SL20703X

lunghezza 181 cm e dispositivo color.
length 181cm and colour device.

SL20703XL

lunghezza 231 cm e dispositivo color.
length 231cm and colour device.

FUSION

TOKYO

TOKYO

STEEL

DIVA

DEKORA
SENSE

SPEED

DEKORA
SENSE

TIARA

SKYLINE

DEKORA
SENSE

SUVI

DEKORA
SENSE

OXY

DEKORA
SENSE

JAX

KIR

TWIN

DEKORA
SENSE



Miscelatore da soffitto in ottone cromato, con miscelazione e controllo flusso integrati nella bocca di erogazione.
Ceiling mixer in chrome plated brass, with mixing and flow control integrated in the outlet spout.

S20703 lunghezza 166 cm.
length 166 cm.

S20703X lunghezza 181 cm.
length 181 cm.

S20703XL lunghezza 231 cm.
length 231 cm.



S20622
 Miscelatore lavabo da incasso.
 Lunghezza bocca: 19 cm.
*Concealed Washbasin mixer.
 Spout Length 19 cm.*



S20655
 Miscelatore monocomando lavabo due fori.
 Altezza: 23,2 cm - Interasse: 17,2 cm.
*Two holes single-lever washbasin mixer.
 Height: 23,2 cm - Interaxis: 17,2 cm.*

LAVABO BOX INCASSO - BUILT-IN BOX WASHBASIN MIXER



S20632KB

Miscelatore monocomando a incasso per lavabo, con piastra in ottone cromato, bocca lunghezza 18 cm, da abbinare al box incasso.

Single-lever built-in basin mixer, with wall flange in chrome plated brass, spout length 18 cm, to match with the built-in box.



DAN BOX632

Box da incasso per miscelatore monocomando a incasso per lavabo.

Built-in box for single-lever built-in basin mixer.

FUSION

TOKYO

TOKYO
STEEL

DIVA
DEKORA
SENSE

BIDET



Monocomando bidet.
Altezza: 17 cm - Interasse: 10 cm
*Single-lever bidet mixer.
Height: 17 cm - Interaxis: 10 cm.*

S20604

Con scarico.
With pop-up waste.

S20604B

Senza scarico.
Without waste.



S20605SH

Miscelatore monocomando lavabo con doccia shut-off e scarico click-clack con troppo pieno.
Single-lever basin mixer with shut-off handshower and click-clack pop-up waste with overflow.

SPEED
DEKORA
SENSE

TIARA

SKYLINE
DEKORA
SENSE

SUVI
DEKORA
SENSE



Miscelatore incasso per shut-off.
Built-in shower mixer.

S20645S

comprensivo di: doccetta shut-off art. 1000DC, supporto doccia-presa acqua, tutto in ottone cromato e flessibile doccia cm 120.
including: shut-off art. 1000DC, shower holder-water punch on flange, all in c.p. brass and shower flexible cm 120.

S20645SH

Miscelatore incasso per shut-off su piastra in ottone cromato.
Built-in shower mixer all in c.p. brass.



S206444DC

Miscelatore shut-off con cartuccia progressiva, apertura su acqua fredda e passaggio ad acqua calda tramite rotazione di maniglia unica, comprensivo di doccetta shut-off art. 1004DC e flessibile doccia cm 120.
Shut-off mixer with progressive cartridge, opening with cold water, switching on hot water by rotating one single handle including shut-off art. 1004DC and shower flexible 120 cm.

OXY
DEKORA
SENSE

JAX

KIR

TWIN
DEKORA
SENSE



S20642

Miscelatore incasso per shut-off con doccetta shut-off, supporto doccia, presa acqua
Built-in shut-off mixer set with shut-off, shower holder, water punch.



S20646

Miscelatore incasso per shut-off.
Built-in shut-off mixer.

MISCELATORI VASCA E DOCCIA - SHOWER AND BATH MIXERS



Miscelatore vasca esterno.
Exposed bath mixer.

S20610

con kit doccia, flessibile 150 cm.
with shower kit, flexible 150 cm.

S20600

con kit doccia, flessibile 120 cm.
with shower kit, flexible 120 cm.

S20600H

senza kit doccia.
without shower kit



S20610XL

Gruppo vasca esterno su colonne da pavimento, con doccia.
 Altezza: 80 cm - Interasse: 20 cm.
Traditional bathtub mixer, floor columns, with shower.
 Height 80 cm - Interaxis 20 cm.



S20691

Miscelatore monocomando bordo vasca.
Single lever deck bath/shower mixer.



S20699

Miscelatore monocomando bordo vasca con bocca multigetto.
Single lever deck bath/shower mixer with multijet spout.



S20678

Miscelatore vasca da pavimento con deviatore e kit doccia.
Altezza bocca: 79 cm - Interasse: 19,5 cm.
Free standing bath mixer floor mounting with diverter and shower kit.
Height spout: 79 cm - Interaxis: 19,5 cm.



S20652

Miscelatore monocomando per vasca da incasso, su piastra in ottone cromato.
Single-lever bath mixer, with wall flange in chrome plated.

FUSION

TOKYO

TOKYO
STEEL



S20606D

Miscelatore monoforo lavabo/vasca, con deviatore e kit doccia.
Single lever one-hole sink/bath mixer with diverter and shower set.

DIVA

DEKORA
SENSE

SPEED

DEKORA
SENSE

TIARA

SKYLINE

DEKORA
SENSE



Monocomando doccia esterno.
Exposed shower mixer.

S20611A

con kit doccia.
with shower kit.

S20611

senza kit doccia.
without shower kit

SUVI

DEKORA
SENSE

OXY

DEKORA
SENSE

JAX

KIR

TWIN

DEKORA
SENSE



A340 435

Saliscendi minimale con doccetta ad 1 funzione.
Altezza: 70 cm.
Minimal sliding rail set with 1 function handshower.
Height: 70 cm.

INCASSI DOCCIA - BUILT-IN MIXERS



S20602

Miscelatore doccia incasso con piastra ultra flat.
Built-in shower mixer with ultra flat flange.



S20612

Miscelatore vasca incasso con deviatore con piastra ultra flat.
Built-in bath/shower mixer with diverter with ultra flat flange.

IN602C35

Parte interna miscelatore monocomando incasso doccia.
Single-lever shower mixer (built-in components).

IN612C35

Parte interna miscelatore monocomando incasso vasca/doccia con deviatore.
Single-lever bath/shower mixer with diverter (built-in components).

S20602EKIT

Parte esterna miscelatore monocomando incasso doccia.
Single-lever shower mixer (external components).

S20612EKIT

Parte esterna miscelatore monocomando incasso vasca/doccia con deviatore.
Single-lever bath/shower mixer with diverter (external components).



S20612D2

Miscelatore monocomando per doccia con deviatore a 2 vie su piastra unica.
Single-lever shower mixer, with 2 ways diverter on single flange.



S20612D3

Miscelatore monocomando per doccia con deviatore a 3 vie e 3 posizioni (una entrata e tre uscite), su unica piastra.
Single lever built-in shower mixer with 3 ways diverter and 3 positions (1 inlet and 3 outlets), on single flange.



S20612D4

Miscelatore monocomando per doccia con deviatore a quattro vie (4 uscite ed 1 entrata) su piastra unica.
Single lever built-in shower mixer with four ways diverter (4 outlets and 1 inlet) on single flange.



S20612D5

Miscelatore monocomando per doccia, con deviatore a 5 vie (5 uscite ed una entrata) su piastra singola.
Single-lever shower mixer with 5 ways diverter (5 outlets and 1 inlet) on single flange.



S20612D7

Miscelatore monocomando per doccia con deviatore a tre vie e sette posizioni su unica piastra.
Single lever built-in shower mixer with three ways diverter with seven positions on single flange.

BOX INCASSO - BUILT-IN BOX

S20602KB

Set miscelatore doccia da abbinare al box incasso.
Shower mixer set to match with the built-in box.



+



DAN BOX

Box da incasso per miscelatore doccia con deviatore.
Built-in box for shower mixer with diverter.

FUSION

TOKYO

S20612KB

Set miscelatore doccia con deviatore da abbinare al box incasso.
Shower mixer set with diverter to match with the built-in box.



+



DAN BOX

Box da incasso per miscelatore doccia con deviatore.
Built-in box for shower mixer with diverter.

TOKYO
STEEL

DIVA

DEKORA
SENSE

S20612D2KB

Set miscelatore doccia due vie da abbinare al box incasso.
Two ways shower mixer set to match with the built-in box.



+



DAN BOXD2

Box da incasso per miscelatore doccia due vie.
Built-in box for two ways shower mixer.

SPEED

DEKORA
SENSE

TIARA

S20612D3KB

Set miscelatore doccia tre vie da abbinare al box incasso.
Three ways shower mixer set to match with the built-in box.



+



DAN BOXD3

Box da incasso per miscelatore doccia tre vie.
Built-in box for three ways shower mixer.

SUVI

DEKORA
SENSE

OXY

DEKORA
SENSE

JAX

S20612D7KB

Set miscelatore doccia tre vie e sette posizioni da abbinare al box incasso.
Three ways and seven positions shower mixer set to match with the built-in box.



+



DAN BOXD3

Box da incasso per miscelatore doccia tre vie.
Built-in box for three ways shower mixer.

KIR

TWIN

DEKORA
SENSE

BOCCHE - SPOUTS



Bocca da soffitto in ottone cromato con dispositivo color.
Ceiling spout in chrome plated brass with colour device.

SL204706 lunghezza 166 cm e dispositivo color.
length 166 cm and colour device.

SL204706X lunghezza 181 cm e dispositivo color.
length 181 cm and colour device.



Bocca da soffitto in ottone cromato.
Ceiling spout in chrome plated brass.

S204706 lunghezza 166 cm.
length 166 cm.

S204706X lunghezza 181 cm.
length 181 cm.



K4704
 Bocca incasso, 18 cm.
Built-in spout, 18 cm.



Bocca incasso per miscelatore vasca-doccia cm 18.
Built-in spout for bath-shower mixer cm 18.



K4702
 Bocca incasso con deviatore, 18 cm.
Built-in spout with diverter, 18 cm.

SL204704 con luce a led.
with led light cartridge.

S204704 senza luce a led.
without led light cartridge.



SC4704

Bocca incasso a cascata.
Built-in spout with waterfall.

A594SC

Soffione doccia con getto a cascata.
C.p. Brass shower head with waterfall jet.



F4705

Bocca bordo vasca con effetto multigetto.
Spout with multijet effect for deck bath/shower mixer.



A750

Sifone minimale in ottone cromato 1"1/4.
C.P. brass minimal P trap 1"1/4.



FUSION

TOKYO

TOKYO
STEEL

DIVA
DEKORA
SENSE

SPEED
DEKORA
SENSE

TIARA

SKYLINE
DEKORA
SENSE

SUVI
DEKORA
SENSE

OXY
DEKORA
SENSE

JAX

KIR

TWIN
DEKORA
SENSE

COLONNE DOCCIA - SHOWER COLUMN



S20611Z

Monocomando doccia esterno con attacco 3/4 M per colonna.
Exposed shower mixer with connection 3/4 M for columns.



S20611ZR

Monocomando doccia esterno con attacco 3/4 M per colonna.
Exposed shower mixer with connection 3/4 M for columns.

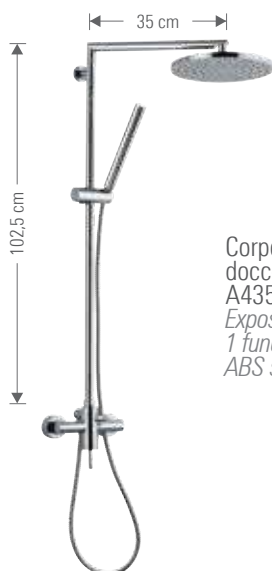

Corpo doccia S20611Z con colonna A201, doccia ad 1 funzione in ottone cromato A435 e soffione in ABS cromato.
Exposed shower mixer with shower column, 1 function c.p. brass hand shower and c.p. ABS shower head.

S20635

con soffione Ø20 cm A584 CM20.
with shower head Ø20 cm A584 CM20.

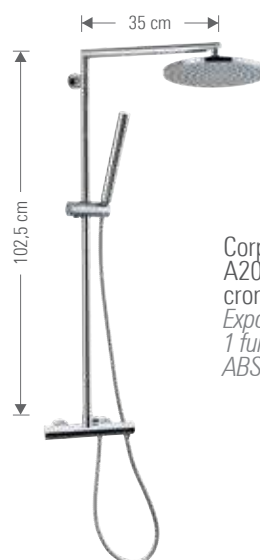

Corpo doccia S20611ZR con colonna A201, doccia ad 1 funzione in ottone cromato A435 e soffione in ABS cromato.
Exposed shower mixer with shower column, 1 function c.p. brass hand shower and c.p. ABS shower head.

S20635R

con soffione Ø20 cm A584 CM20.
with shower head Ø20 cm A584 CM20.

S20635B

con soffione Ø25 cm A584 CM25.
with shower head Ø25 cm A584 CM25.

S20635RB

con soffione Ø25 cm A584 CM25.
with shower head Ø25 cm A584 CM25.

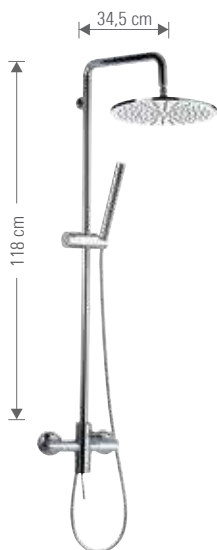

S20636C

Corpo doccia S20611Z con colonna doccia deluxe girevole, doccia ad 1 funzione A435 e soffione tutto in ottone cromato Ø20 cm A594.
Exposed shower mixer S20611Z with swivelling deluxe shower column, c.p. brass 1 function handshower A435 and shower head all in brass Ø20 cm A594.

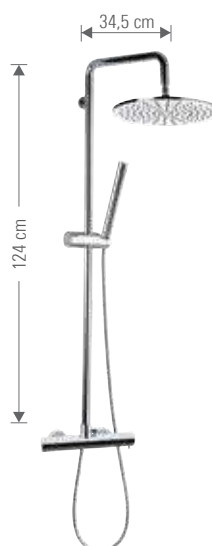

S20636RC

Corpo doccia S20611ZR con colonna doccia deluxe girevole, doccia ad 1 funzione A435 e soffione Ø30 cm A594 CM30. Tutto in ottone cromato.
Exposed shower mixer S20611ZR with swivelling deluxe shower column, 1 function handshower A435 and shower head Ø30 cm A594 CM30. All in c.p. brass.

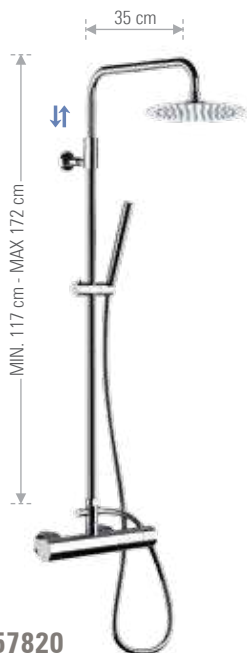

S636RA4357820

Colonna doccia serie Suvi con miscelatore doccia con deviatore e attacco alto da 3/4", colonna doccia telescopica, doccetta ad 1 funzione in ottone cromato, con flessibile A505X 150 cm e soffione a pioggia, in acciaio INOX Ø 20 cm, con getti in silicone anticalcare.

Suvi series shower column with shower mixer with with diverter and upper connection 3/4", with telescopic shower column, c.p. handshower 1 function in c.p. brass, with A505X 150 cm flexible hose and c.p. stainless steel shower head, rain jet, Ø 20 cm, with anti-limestone silicon jets.



S636RA8420

Colonna doccia serie Suvi con miscelatore doccia con deviatore attacco alto da 3/4", colonna doccia telescopica, doccetta anticalcare ad 1 funzione, con flessibile A505X 150 cm e soffione a pioggia, in ABS cromato, Ø 20 cm, con getti in silicone anticalcare.

Suvi series shower column with shower mixer with diverter and upper connection 3/4", with telescopic shower column, c.p. handshower 1 function antilimestone, with A505X 150 cm flexible hose and c.p. ABS shower head, rain jet, Ø 20 cm, with anti-limestone silicon jets.



FUSION

TOKYO

TOKYO
STEEL

DIVA
DEKORA
SENSE

SPEED
DEKORA
SENSE

TIARA

SKYLINE
DEKORA
SENSE

SUVI
DEKORA
SENSE

OXY
DEKORA
SENSE

JAX

KIR

TWIN
DEKORA
SENSE

COLONNE DOCCIA FREESTANDING PER PISCINA
SHOWER COLUMN FREESTANDING FOR SWIMMING POOL



A291636

Colonna con miscelatore acqua calda-fredda saliscendi free-standing con attacco da pavimento, con deviatore, doccetta e flessibile doccia cm 200, soffione anticalcare Ø 30 cm.
Free-standing column with single lever mixer hot/cold water control, with diverter and sliding bar, with handshower, flexible cm 200 and antilimestone shower head Ø 30 cm



A291637

Colonna free-standing con miscelatore acqua calda-fredda, con attacco da pavimento, con soffione anticalcare Ø 30 cm.
Free-standing chrome plated brass column with single lever mixer hot/cold water control, with anti-limestone shower head Ø 30 cm.

FREESTANDING MONOACQUA - SINGLE WATER FREESTANDING



A290636

Colonna saliscendi free-standing in ottone cromato con attacco da pavimento, con comando monoacqua, deviatore, doccetta ad 1 funzione e flessibile doccia cm 200, soffione anticalcare Ø 30 cm.
Free-standing chrome plated brass column with single water control, with diverter and sliding bar, with c.p. brass handshower with flexible cm 200 and shower head Ø 30 cm.

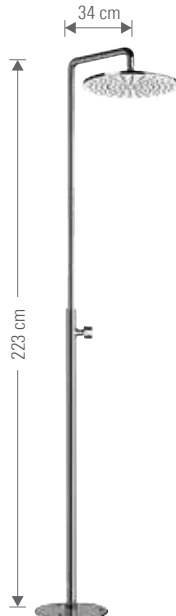

A290637

Colonna free-standing in ottone cromato con attacco da pavimento, con comando monoacqua e soffione anticalcare Ø 30 cm.
Free-standing chrome plated brass column with single water control, with c.p. brass anti-limestone shower head Ø 30 cm



Set doccia con soffione doccia ultra piatto in acciaio INOX lucidato a specchio con getti anticalcare in silicone. braccio in ottone cromato 30 cm, saliscendi minimale con doccetta ad 1 funzione, flessibile conico; tutto in ottone cromato, presa acqua tipo rotondo pesante, miscelatore incasso con deviatore e piastra lusso.

Shower kit with ultra slim stainless steel mirror polished shower head with silicon antilimestone jets, c.p. brass arm 30 cm, sliding bar with minimal 1 function handshower, flexible hose 150 cm; all in c.p. brass, wall connector round heavy type in c.p. brass, and built-in mixer with diverter and deluxe flange.

S20614Z7820

Disponibile con soffione da cm Ø20 cm e braccio da 30 cm.
Available with head shower cm Ø20 cm and arm 30 cm.

S20614Z7825

Disponibile con soffione da cm Ø25 cm e braccio da 30 cm.
Available with head shower cm Ø25 cm and arm 30 cm.

S20614Z7830

Disponibile con soffione da cm Ø30 cm e braccio da 30 cm.
Available with head shower cm Ø30 cm and arm 30 cm.

S20614Z7840

Disponibile con soffione da cm Ø40 cm e braccio da 40 cm.
Available with head shower cm Ø40 cm and arm 40 cm.



Set doccia con soffione doccia ultra piatto in acciaio INOX lucidato a specchio con getti anticalcare in silicone. braccio in ottone cromato 30 cm, doccetta ad 1 funzione con supporto presa acqua e flessibile conico 150 cm, tutto in ottone cromato, miscelatore incasso con deviatore e piastra lusso.

Shower kit with ultra slim stainless steel mirror polished shower head, with c.p. brass arm, water punch/shower holder with 1 function handshower and shower flexible hose 150 cm, all in c.p. brass, built-in mixer with diverter and deluxe flange.

S20615Z7820

Disponibile con soffione da cm Ø20 cm e braccio da 30 cm.
Available with head shower cm Ø20 cm and arm 30 cm.

S20615Z7825

Disponibile con soffione da cm Ø25 cm e braccio da 30 cm.
Available with head shower cm Ø25 cm and arm 30 cm.

S20615Z7830

Disponibile con soffione da cm Ø30 cm e braccio da 30 cm.
Available with head shower cm Ø30 cm and arm 30 cm.

S20615Z7840

Disponibile con soffione da cm Ø40 cm e braccio da 40 cm.
Available with head shower cm Ø40 cm and arm 40 cm.



Set doccia con soffione doccia ultra piatto in acciaio INOX lucidato a specchio con getti anticalcare in silicone. braccio in ottone cromato 30 cm, saliscendi minimale con doccetta ad 1 funzione, flessibile conico; tutto in ottone cromato, presa acqua tipo rotondo pesante, miscelatore monocomando per doccia a 3 vie e 7 posizioni su piastra unica, 6 getti anticalcare in ottone cromato.

Shower kit with ultra slim stainless steel mirror polished shower head with silicon antilimestone jets, c.p. brass arm 30 cm, sliding bar with minimal 1 function handshower, flexible hose 150 cm; all in c.p. brass, wall connector round heavy type in c.p. brass, and single lever built-in shower mixer with 3 ways and 7 positions on single flange, 6 jets anti-limestone in c.p. brass.

S20613Z7820

Disponibile con soffione da cm Ø20 cm e braccio da 30 cm.
Available with head shower cm Ø20 cm and arm 30 cm.

S20613Z7825

Disponibile con soffione da cm Ø25 cm e braccio da 30 cm.
Available with head shower cm Ø25 cm and arm 30 cm.

S20613Z7830

Disponibile con soffione da cm Ø30 cm e braccio da 30 cm.
Available with head shower cm Ø30 cm and arm 30 cm.

S20613Z7840

Disponibile con soffione da cm Ø40 cm e braccio da 40 cm.
Available with head shower cm Ø40 cm and arm 40 cm.



Set doccia con soffione doccia ultra piatto in acciaio INOX lucidato a specchio con getti anticalcare in silicone. braccio in ottone cromato 30 cm, doccetta ad 1 funzione con supporto presa acqua e flessibile conico 150 cm, tutto in ottone cromato, miscelatore monocomando per doccia a 3 vie e 7 posizioni su piastra unica, 6 getti anticalcare in ottone cromato.

Shower kit with ultra slim stainless steel mirror polished shower head, with c.p. brass arm, water punch/shower holder with 1 function handshower and shower flexible hose 150 cm, all in c.p. brass, and single lever built-in shower mixer with 3 ways and 7 positions on single flange, 6 jets anti-limestone in c.p. brass.

S20616Z7820

Disponibile con soffione da cm Ø20 cm e braccio da 30 cm.
Available with head shower cm Ø20 cm and arm 30 cm.

S20616Z7825

Disponibile con soffione da cm Ø25 cm e braccio da 30 cm.
Available with head shower cm Ø25 cm and arm 30 cm.

S20616Z7830

Disponibile con soffione da cm Ø30 cm e braccio da 30 cm.
Available with head shower cm Ø30 cm and arm 30 cm.

S20616Z7840

Disponibile con soffione da cm Ø40 cm e braccio da 40 cm.
Available with head shower cm Ø40 cm and arm 40 cm.



Set doccia con soffione doccia ultrapiatto 50x25 cm, a parete in acciaio INOX lucidato a specchio, saliscendi minimale con doccetta ad 1 funzione completamente in ottone cromato e flessibile conico in ottone cromato, presa acqua tipo rotondo pesante e miscelatore monocomando per doccia con deviatore a tre vie e sette posizioni su unica piastra.

Shower set with ultra slim stainless steel mirror polished wall shower head 50x25 cm, sliding bar with 1 function handshower, completely in c.p. brass and with shower flexible hose in brass cm 150, brass wall connector, round heavy type, single lever built-in shower mixer with three ways diverter with seven position on single flange.

S20614ZSSCA

Disponibile con soffione doccia ultrapiatto 50x25 cm, a parete in acciaio INOX lucidato a specchio, 2 getti, pioggia e cascata.

Available with ultra slim stainless steel mirror polished wall shower head, 2 jets rain and waterfall.

S20614ZSS

Disponibile con soffione doccia ultrapiatto 50x25 cm, a parete in acciaio INOX lucidato a specchio, getto a pioggia.

Available with ultra slim stainless steel mirror polished wall shower head, rain jet.



Set doccia con soffione doccia ultrapiatto 50x25 cm, a parete in acciaio INOX lucidato a specchio, doccetta ad 1 funzione con supporto presa acqua e flessibile conico 150 cm tutto in ottone cromato, miscelatore monocomando per doccia con deviatore a tre vie e sette posizioni su unica piastra.

Shower set with ultra slim stainless steel mirror polished wall shower head, 50x25 cm, water punch/shower holder with 1 function handshower and shower flexible hose 150 cm, all in c.p. brass, single lever built-in shower mixer with three ways diverter with seven position on single flange.

S20615ZSSCA

Disponibile con soffione doccia ultrapiatto 50x25 cm, a parete in acciaio INOX lucidato a specchio, 2 getti, pioggia e cascata.

Available with ultra slim stainless steel mirror polished wall shower head, 2 jets rain and waterfall.

S20615ZSS

Disponibile con soffione doccia ultrapiatto 50x25 cm, a parete in acciaio INOX lucidato a specchio, getto a pioggia.

Available with ultra slim stainless steel mirror polished wall shower head, rain jet.





Set doccia con soffione doccia ultrapiatto 50x25 cm, a parete in acciaio INOX lucidato a specchio, doccetta ad 1 funzione con supporto presa acqua e flessibile conico 150 cm tutto in ottone cromato, miscelatore monocomando per doccia con deviatore a tre vie e sette posizioni su unica piastra e 6 getti anticalcare in ottone cromato.

Shower set with ultra slim stainless steel mirror polished wall shower head, 50x25 cm, water punch/shower holder with 1 function handshower and shower flexible hose 150 cm, all in c.p. brass, single lever built-in shower mixer with three ways diverter with seven position on single flange, 6 jets anti-limestone inc.p. brass.

S20616ZSSCA

Disponibile con soffione doccia ultrapiatto 50x25 cm, a parete in acciaio INOX lucidato a specchio, 2 getti, pioggia e cascata.

Available with ultra slim stainless steel mirror polished wall shower head, 2 jets rain and waterfall.

S20616ZSS

Disponibile con soffione doccia ultrapiatto 50x25 cm, a parete in acciaio INOX lucidato a specchio, getto a pioggia.

Available with ultra slim stainless steel mirror polished wall shower head, rain jet.



Set doccia con soffione doccia ultrapiatto 50x25 cm, a parete in acciaio INOX lucidato a specchio, saliscendi minimale con doccetta ad 1 funzione completamente in ottone cromato e flessibile conico in ottone cromato, presa acqua tipo rotondo pesante e miscelatore monocomando per doccia con deviatore a tre vie e sette posizioni su unica piastra e 6 getti anticalcare in ottone cromato.

Shower set with ultra slim stainless steel mirror polished wall shower head 50x25 cm, sliding bar with 1 function handshower, completely in c.p. brass and with shower flexible hose in brass cm 150, brass wall connector, round heavy type, single lever built-in shower mixer with three ways diverter with seven position on single flange, 6 jets anti-limestone inc.p. brass.

S20613ZSSCA

Disponibile con soffione doccia ultrapiatto 50x25 cm, a parete in acciaio INOX lucidato a specchio, 2 getti, pioggia e cascata.

Available with ultra slim stainless steel mirror polished wall shower head, 2 jets rain and waterfall.

S20613ZSS

Disponibile con soffione doccia ultrapiatto 50x25 cm, a parete in acciaio INOX lucidato a specchio, getto a pioggia.

Available with ultra slim stainless steel mirror polished wall shower head, rain jet.



FUSION

TOKYO

TOKYO
STEEL

DIVA
DEKORA
SENSE

SPEED
DEKORA
SENSE

TIARA

SKYLINE
DEKORA
SENSE

SUVI
DEKORA
SENSE

OXY
DEKORA
SENSE

JAX

KIR

TWIN
DEKORA
SENSE



S20615ZC

Set doccia con soffione a cascata, miscelatore vasca incasso con deviatore, doccetta ad 1 funzione con supporto presa acqua e flessibile conico 150 cm. Tutto in ottone cromato.

Shower set with shower head with waterfall jet, built-in bath mixer with diverter, water punch/shower holder with 1 function handshower and shower flexible hose 150 cm..All in c.p. brass.



S20616ZC

Set doccia con soffione a cascata, doccetta ad 1 funzione con supporto presa acqua e flessibile conico 150 cm. Tutto in ottone cromato. 6 getti minimali anticalcare e miscelatore e deviatore 3 vie e 7 posizioni. Tutto in ottone cromato.

Shower set with shower head with waterfall jet, water punch/shower holder with 1 function handshower and shower flexible hose 150 cm, 6 minimal jets antilimestone and shower mixer and 3 ways diverter and 7 positions. All in c.p. brass.



S20613Z

Set doccia con soffione Ø20 cm anticalcare con braccio 30 cm, saliscendi con doccetta ad 1 funzione, attacco presa acqua da 1/2 tipo rotondo pesante, miscelatore e deviatore 3 vie e 7 posizioni e 6 getti anticalcare. Tutto in ottone cromato.

Shower set with antilimestone shower head Ø20 cm with arm 30 cm, sliding rail with hand shower 1 function, water punch connector, round and heavy type, shower mixer and 3 ways diverter and 3 ways diverter and 7 positions and 6 jets antilimestone. All in c.p. brass.



S20616Z

Set doccia con soffione anticalcare Ø20 cm con braccio in ottone 30 cm, doccetta in ottone cromato ad 1 funzione con supporto doccia presa acqua lusso e flessibile 150 cm, 6 getti anticalcare e miscelatore e deviatore 3 vie e 7 posizioni. Tutto in ottone cromato.

Shower set with antilimestone shower head Ø20 cm with arm 30 cm, 1 function hand shower with shower holder/water punch and flexible hose 150 cm, 6 minimal jets antilimestone and shower mixer and 3 ways diverter and 7 positions. All in c.p. brass.



S20614Z

Set doccia con soffione anticalcare Ø20 cm con braccio 30 cm, miscelatore vasca/doccia incasso con deviatore, saliscendi con doccetta ad 1 funzione, attacco presa acqua da 1/2 tipo rotondo pesante. Tutto in ottone cromato.

Shower set with antilimestone shower head Ø20 cm with arm 30 cm, built-in shower mixer with diverter, sliding rail with 1 function hand shower, wall water punch connector round heavy type. All in c.p. brass.



S20615Z

Set doccia con soffione anticalcare con braccio cm 30, miscelatore vasca incasso con deviatore, doccetta in ottone cromato ad 1 funzione con supporto doccia presa acqua lusso e flessibile 150 cm. Tutto in ottone cromato.

Shower set with shower head with arm cm 30, built-in shower mixer with diverter, 1 function hand shower with shower holder/water punch and flexible hose 150 cm. All in c.p. brass.



S20617Z

Set doccia con soffione anticalcare Ø20 cm con braccio 30 cm, miscelatore e deviatore 3 vie e 7 posizioni, doccetta ad 1 funzione e supporto presa acqua lusso con flessibile 150 cm, bocca incasso. Tutto in ottone cromato.

Shower set with antilimestone shower head Ø20 cm with arm 30 cm, 1 function hand shower with shower holder/water punch and flexible hose 150 cm, shower mixer 3 ways diverter and 7 positions, built-in spout. All in c.p. brass.



S20619Z

Set doccia composto da colonna doccia con presa acqua, doccetta ad 1 funzione e soffione anticalcare Ø 20 cm, miscelatore vasca/doccia incasso con deviatore, bocca incasso. Tutto in ottone cromato.

Shower set composed of shower column with water punch, 1 function handshower, antilimestone shower head Ø20 cm, built-in bath mixer with diverter, built-in spout. All in c.p. brass.

FUSION

TOKYO

TOKYO
STEEL

DIVA

DEKORA
SENSE

SPEED

DEKORA
SENSE

TIARA

SKYLINE

DEKORA
SENSE

SUVI

DEKORA
SENSE

OXY

DEKORA
SENSE

JAX

KIR

TWIN

DEKORA
SENSE

CUCINA - KITCHEN

AMBIENT



SA20608

Monocomando lavello bocca girevole dotato di dispositivo luminoso AMBIENT di retroilluminazione.

Altezza: 27 cm - Interasse: 20 cm.

Single-lever Sink mixer swivelling spout with led light AMBIENT device for back lighting.

Height: 27 cm - Interaxis 20 cm.



KCA101

Monocomando lavello bocca girevole dotato di dispositivo luminoso AMBIENT con illuminazione sotto la bocca di erogazione.

Altezza: 24,8 cm - Interasse: 20 cm.

Single-lever Sink mixer swivelling spout with led light AMBIENT device with light under the spout.

Height: 24,8 cm - Interaxis 20 cm.

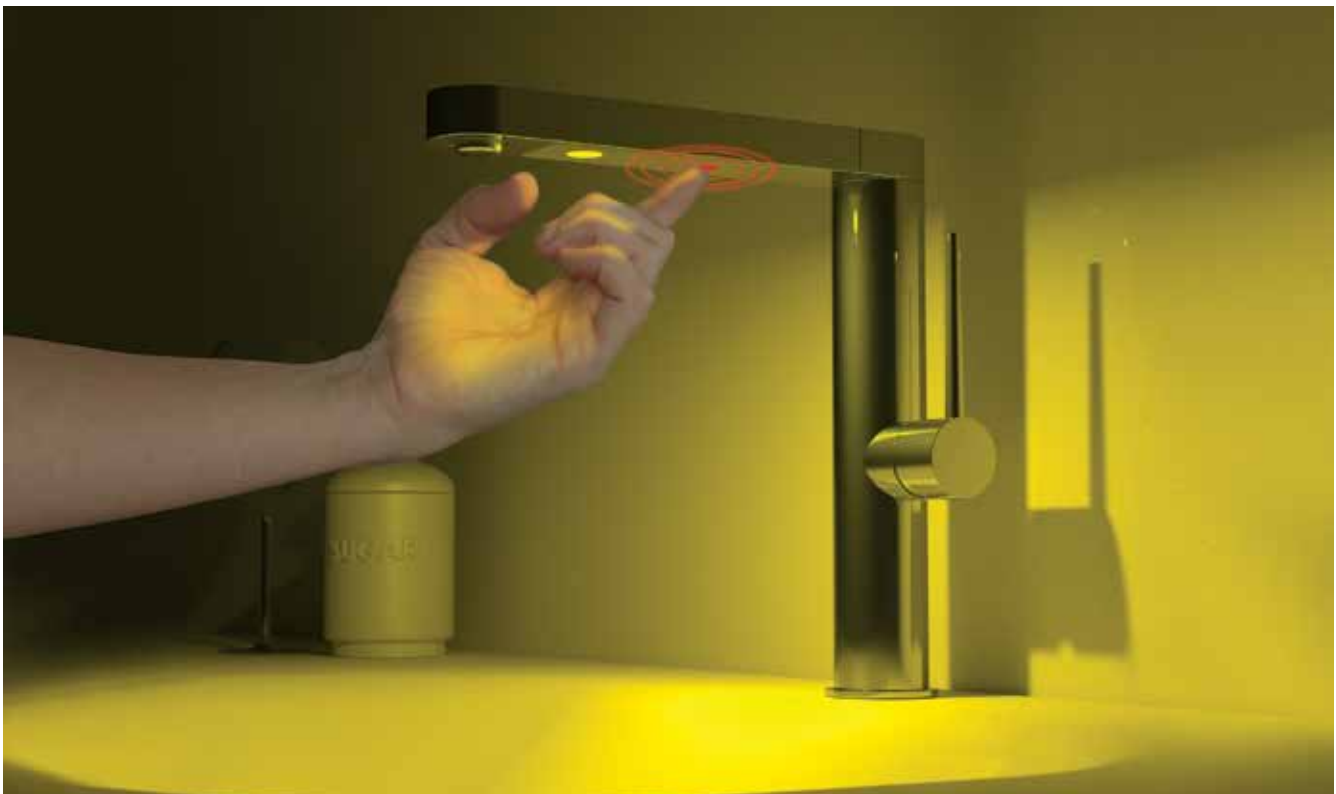



S20608

Miscelatore lavello con canna girevole.
 Altezza: 26 cm - Interasse: 18,5 cm.
Single-lever sink mixer with swivelling spout.
 Height: 26 cm - Interaxis 18,5 cm.



S20613

Miscelatore monocomando lavello con doccia estraibile.
 Altezza: 29 cm - Interasse: 20,5 cm.
Single-lever sink mixer with pull-out spray-jet shower.
 Height: 29 cm - Interaxis 20,5 cm.

GOURMET



S20233

Miscelatore lavello monocomando con flessibile nero rivestito con molla "fine design" girevole 360°, con doccetta estraibile ed orientabile a due funzioni e cartuccia Ø 35.
 Altezza: 40,7 cm - Interasse: 21 cm.
Single-lever mixer with black flexible hose coated with "fine design" spring, 360° movable, with pull-out and swivelling 2-functions hand shower and Ø 35 mm cartridge.
 Height: 40,7 cm - Interaxis 21 cm.



S20689

Miscelatore monocomando lavello a molla con doccetta estraibile ed orientabile a due funzioni e cartuccia Ø 35.
 Altezza: 48 cm - Interasse: 21,5 cm.
Spring single-lever sink mixer with pull-out and swivelling 2-functions hand shower and Ø 35 mm cartridge.
 Height: 48 cm - Interaxis 21,5 cm.



S20638

Miscelatore monocomando laterale per lavello, alto, con bocca girevole a molla in acciaio inox elettrolucidato e doccetta monogetto
 Altezza: 42 cm - Interasse: 18 cm.
Single-lever mixer for sink, with side lever, high movable spring spout in stainless steel electro polished with shower.
 Height: 42 cm - Interaxis 18 cm.



SL20638

Miscelatore monocomando laterale per lavello, alto, con bocca girevole a molla in acciaio inox elettrolucidata, flessibile in acciaio inox ricoperto in pvc metallizzato e doccetta monogetto con luce led.
 Altezza: 58 cm - Interasse: 18 cm.
Single-lever mixer for sink, with side lever, high movable spring spout in stainless steel electro polished with shower and led light.
 Height: 58 cm - Interaxis 18 cm.



S20684

Miscelatore monocomando laterale per lavello alto, con bocca girevole a molla in acciaio inox elettrolucidato, flessibile e doccetta a due funzioni.
 Materiale: miscelatore in ottone cromato, molla in acciaio inox, flessibile in acciaio inox ricoperto in pvc metallizzato argento.
 Altezza: 72 cm - Interasse: 29,5 cm max.
Single-lever mixer for sink, with side lever, high movable spring spout in stainless steel electro polished with hand shower, two functions. Material: mixer in c.p. brass, spring spout in stainless steel with stainless steel flexible covered with silver colour pvc, hand shower in c.p. ABS.
 Height: 72 cm - Interaxis 29,5 cm max.



SL20684

Miscelatore monocomando laterale per lavello alto, con bocca girevole a molla in acciaio inox elettrolucidata, flessibile e doccetta monogetto con luce led.
 Altezza: 72 cm - Interasse: 29,5 cm max.
Single-lever mixer for sink, with side lever, high movable spring spout in stainless steel electro polished with hand shower and led light.
 Height: 72 cm - Interaxis 29,5 cm max.

ACQUA DEPURATA - PURIFIED WATER



TEMT608DW

Miscelatore lavello a tre vie di ingresso con bocca girevole, con selezione acqua potabile tramite pulsante ad azionamento piezoelettrico alimentato a batteria, con 2 aeratori in uscita.

Altezza: 29,5 cm - Interasse: 21,5 cm.

Three ways inlet single lever sink mixer, with movable spout, with selection for drinking water with piezoelectric activation button, with 2 exit aerators.

Height: 29,5 cm - Interaxis 21,5 cm.



S20679DW

Miscelatore lavello serie Suvi a tre vie di ingresso con bocca girevole e due vie d'uscita completamente indipendenti, con selezione acqua potabile tramite la leva.

Altezza: 35,7 cm - Interasse: 17,2 cm.

Three ways inlet Suvi series single lever sink mixer, with movable spout and two fully independent outlets, with selection for drinking water directly from the lever.

Height: 35,7 cm - Interaxis 17,2 cm.



S20608DW

Miscelatore lavello a tre vie di ingresso con bocca girevole, con selezione acqua potabile tramite la leva, con 2 aeratori indipendenti in uscita.

Altezza: 31,7 cm - Interasse: 21,5 cm.

Three ways inlet single lever sink mixer, with movable spout, with selection for drinking water directly from the lever, with 2 independent exit aerators.

Height: 31,7 cm - Interaxis 21,5 cm.

FUSION

TOKYO

TOKYO
STEEL

DIVA
DEKORA
SENSE

SPEED
DEKORA
SENSE

TIARA

SKYLINE
DEKORA
SENSE

SUVI
DEKORA
SENSE

OXY
DEKORA
SENSE

JAX

KIR

TWIN
DEKORA
SENSE



OXY

Icona di un design squadrato e minimale, la collezione OXY asseconda un progetto di estrema essenzialità, creando una geometria precisa di grande eleganza e leggerezza.
Design di Cristian Mapelli.

*Icon of a square and minimalist design, the OXY collection follows a project of utmost essentiality, creating a precise geometry with great elegance and lightness.
Design By Cristian Mapelli.*

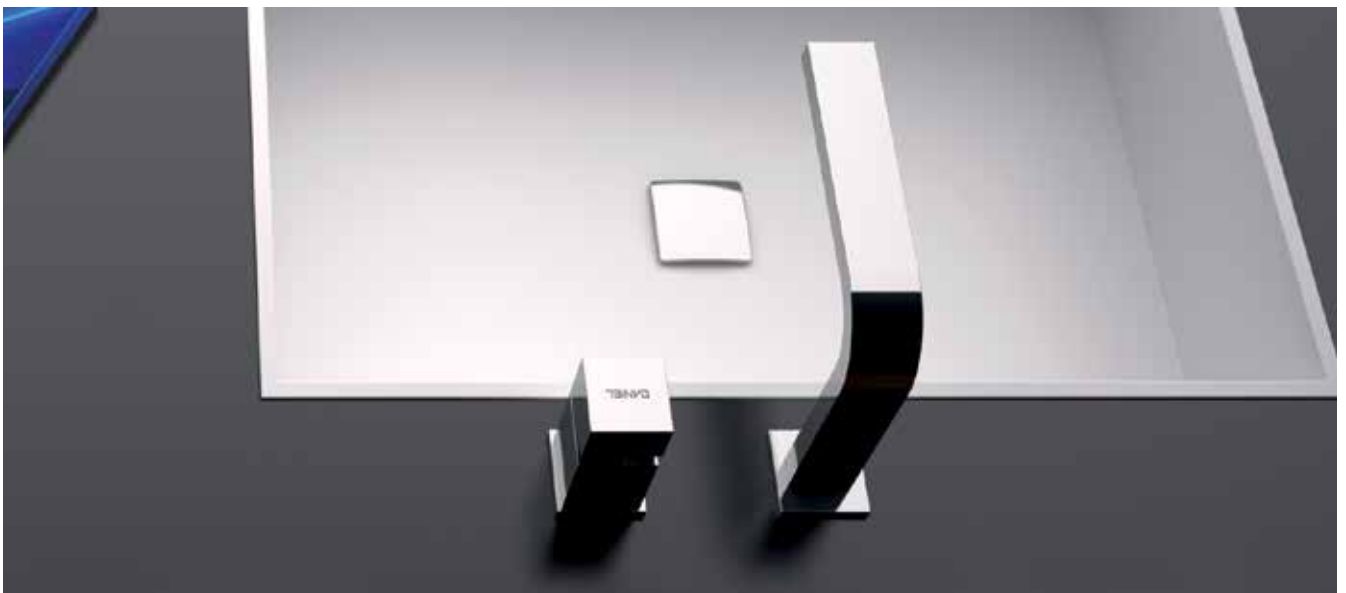

FUSION

TOKYO

TOKYO
STEEL

DIVA
DEKORA
SENSE

SPEED
DEKORA
SENSE

TIARA

SKYLINE

DEKORA
SENSE

SUVI

DEKORA
SENSE

OXY

DEKORA
SENSE

JAX

KIR

TWIN

DEKORA
SENSE



FINISHINGS

FIN 2

- | | | | | |
|--|---|---|---------------------------------------|-------------------------------------|
| CP cromo spazzolato
brushed chrome | NP nichel spazzolato
brushed nickel | NPO nichel spazzolato opaco
matt brushed nickel | 63 vecchio ottone
old brass | OIL oil bronze
oil bronze |
| 64 vecchio rame
old copper | 14 bianco opaco
matt white | 15 nero opaco
matt black | | |

FIN 4

- | | | | | | |
|------------------------------------|--|---------------------------------------|--|---|-------------------------------|
| DO oro lucido
shiny gold | DP oro spazzolato
brushed gold | RL rame lucido
shiny copper | FZ cromo nero spazzolato lucido
shiny brushed black chrome | CF cromo nero lucido
shiny black chrome | GO grafite
graphite |
|------------------------------------|--|---------------------------------------|--|---|-------------------------------|

FIN 5

- | | | |
|--|--|---|
| PG oro rosa lucido
shiny pink gold | PP oro rosa spazzolato
brushed pink gold | RPO rame anodizzato
anodised copper |
|--|--|---|

Finiture consigliate per questa collezione.
Per l'elenco completo fare riferimento alla tabella delle finiture (pag.04)

*Suggested finishes for this collection.
For a complete list of available colors, please refer to the finishing table (page 04)*

DECORI DISPONIBILI:
AVAILABLE DECORATIONS: POP ART YL



DECO 1

- | | |
|---|--|
| YL80 cromo lucido, decoro nichel spazzolato.
shiny chrome, brushed nickel decoration. | YL81 cromo lucido, decoro oro spazzolato.
shiny chrome, brushed gold decoration. |
|---|--|

DECO 2

- | | | |
|---|---|--|
| YL84 nichel spazzolato, decoro cromo lucido.
brushed nickel, shiny chrome decoration. | YL86 nichel spazzolato, decoro canna di fucile spazzolato.
brushed nickel, brushed gun barrel decoration. | YL97 nichel spazzolato, decoro nichel lucido.
brushed nickel, shiny nickel decoration. |
|---|---|--|

DECO 4

- | | | |
|---|---|--|
| YL85 nichel spazzolato, decoro oro spazzolato.
brushed nickel, brushed gold decoration. | YL95 canna di fucile spazzolato, decoro cromo.
brushed gun barrel, chrome decoration. | YL98 ottone spazzolato decoro ottone lucido.
brushed brass shiny brass decoration. |
|---|---|--|

DECO 5

- | | | |
|--|---|--|
| YL82 oro lucido, decoro oro spazzolato.
shiny gold, brushed gold decoration. | YL83 oro lucido, decoro nichel spazzolato.
shiny gold, brushed nickel decoration. | YL88 oro antico, decoro canna di fucile spazzolato.
antique gold, brushed gun barrel decoration. |
|--|---|--|

- | |
|---|
| YL96 oro spazzolato, decoro cromo.
brushed gold, chrome decoration. |
|---|

DECO 6

- | | |
|--|--------------------------------------|
| YL14 Bianco Opaco
Matt White | YL15 Nero Opaco
Matt Black |
|--|--------------------------------------|

DEKORA

SENSE

CARATTERISTICHE TECNICHE:

La serie è dotata di cartuccia a dischi ceramici Ø 25 mm, tranne gli incassi che utilizzano la cartuccia a dischi ceramici Ø 35 mm. Cartucce prodotte da S.T.S.R. – Studio Tecnico Sviluppo e Ricerche, www.stsr.it

TECHNICAL CHARACTERISTICS:

The series is equipped with ceramic cartridge Ø25 mm, except built-in items that use ceramic cartridge Ø35 mm. Cartridges are produced by S.T.S.R. - Research Development Technical Office, www.stsr.it

LAVABI - WASHBASIN MIXERS



Monocomando lavabo
Altezza: 16,7 cm - Interasse: 10,5 cm
*Single-lever basin mixer.
Height: 16,7 cm - Interaxis: 10,5 cm.*

OX23605

Con scarico.
With pop-up waste.

OX23606

Senza scarico.
Without waste.



OX23634

Miscelatore monocomando a incasso per lavabo, con piastra rettangolare verticale. Lunghezza bocca: 18 cm.
Single-lever built-in basin mixer, with vertical rectangular wall flange. Spout length: 18 cm.



OX23632

Miscelatore monocomando a incasso per lavabo, con piastra rettangolare. Lunghezza bocca: 18 cm.
Single-lever built-in basin mixer, with rectangular wall flange. Spout length: 18 cm.



Monocomando lavabo
Altezza: 27 cm - Interasse: 10,5 cm
*Single-lever basin mixer.
Height: 27 cm - Interaxis: 10,5 cm.*

OX23607

Con scarico click-clack.
With click-clack waste.

OX23607B

Senza scarico.
Without waste.

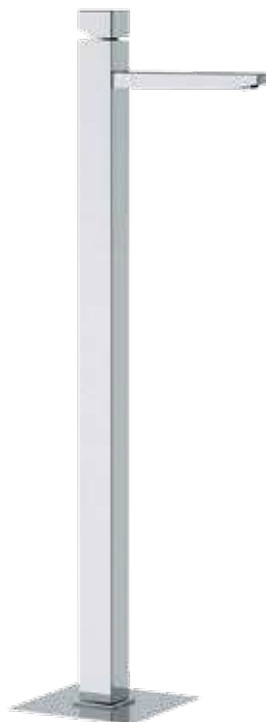

OX23688

Miscelatore monocomando lavabo da pavimento con click-clack e troppo pieno. Altezza bocca: 94 cm - Interasse: 17 cm
Single-lever mixer floor mounting with click-clack and overflow. Height spout: 94 cm - Interaxis: 17 cm.



OX23655

Miscelatore monocomando lavabo due fori.
Altezza: 16,5 cm - Interasse: 15,1 cm
Two holes single-lever washbasin mixer.
Height: 16,5 cm - Interaxis: 15,1 cm.



FUSION

TOKYO

TOKYO
STEEL

LAVABO BOX INCASSO - BUILT-IN BOX WASHBASIN MIXER

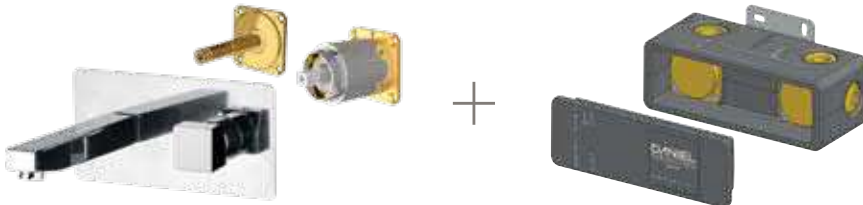

OX23632KB

Miscelatore monocomando a incasso per lavabo, con piastra in ottone cromato, bocca lunghezza 18 cm, da abbinare al box incasso.
Single-lever built-in basin mixer, with wall flange in chrome plated brass, spout length 18 cm, to match with the built-in box.

DAN BOX632

Box da incasso per miscelatore monocomando a incasso per lavabo.
Built-in box for single-lever built-in basin mixer.

DIVA

DEKORA
SENSE

SPEED

DEKORA
SENSE

TIARA

SKYLINE

DEKORA
SENSE

BIDET

SUVI

DEKORA
SENSE



OX23604

Con scarico.
With pop-up waste.

Monocomando bidet.
Altezza: 15,5 cm - Interasse: 8 cm
Single-lever bidet mixer.
Height: 15,5 cm - Interaxis: 8 cm.

OX23604B

Senza scarico.
Without waste.



OX23642

Miscelatore incasso per shut-off con doccetta shut-off, supporto doccia, presa acqua
Built-in shut-off mixer set shut-off, shower holder, water punch.

OXY

DEKORA
SENSE

JAX

KIR



OX23646

Miscelatore incasso per shut-off.
Built-in shut-off mixer.

TWIN

DEKORA
SENSE

MISCELATORI VASCA E DOCCIA - SHOWER AND BATH MIXERS



Miscelatore vasca esterno.
Exposed bath mixer.

OX23610 con kit doccia, flessibile 150 cm.
with shower kit, flexible 150 cm.

OX23600 con kit doccia, flessibile 120 cm.
with shower kit, flexible 120 cm.

OX23600H senza kit doccia.
without shower kit



OX23678

Miscelatore vasca da pavimento con deviatore e kit doccia.
Free standing bath mixer floor mounting with diverter and shower kit
Altezza bocca: 80 cm - Interasse: 22,3 cm
Height spout: 80 cm - Interaxis: 22,3 cm.





OX23691
Miscelatore monocomando bordo vasca.
Single lever deck bath/shower mixer.



Monocomando doccia esterno.
Exposed shower mixer.

OX23611A con kit doccia.
with shower kit.

OX23611 senza kit doccia.
without shower kit.



A345 495
Saliscendi completamente in ottone cromato quadro con doccetta ad 1 funzione.
Altezza 70 cm.
C.p. brass square sliding rail set with 1 function handshower. Height 70 cm.



OX23611Z
Monocomando doccia esterno con attacco 3/4 M per colonna.
Exposed shower mixer with connection 3/4 M for columns.

FUSION

TOKYO

TOKYO
STEEL

DIVA
DEKORA
SENSE

SPEED
DEKORA
SENSE

TIARA

SKYLINE
DEKORA
SENSE

SUVI
DEKORA
SENSE

OXY
DEKORA
SENSE

JAX

KIR

TWIN
DEKORA
SENSE

COLONNE DOCCIA - SHOWER COLUMN



OX23637Q
Corpo doccia con colonna e soffione tutto in ottone cromato.
Exposed shower mixer with shower column and shower head all in brass.



OX23636Q
Corpo doccia con colonna, doccetta ad 1 funzione e soffione tutto in ottone cromato.
Exposed shower mixer with shower column, 1 function handshower and shower head all in brass.

INCASSI DOCCIA - BUILT-IN MIXERS



OX23602
 Miscelatore doccia incasso.
Single-lever Built-in shower mixer.

IN602C35 Parte interna miscelatore monocomando incasso doccia.
Single-lever shower mixer (built-in components).

OX23602EKIT Parte esterna miscelatore monocomando incasso vasca/doccia con deviatore.
Single-lever bath/shower mixer with diverter (external components).



OX23612
 Miscelatore vasca incasso con deviatore.
Built-in bath/shower mixer with diverter.

IN612C35 Parte interna miscelatore monocomando incasso vasca/doccia con deviatore.
Single-lever bath/shower mixer with diverter (built-in components).

OX23612EKIT Parte esterna miscelatore monocomando incasso vasca/doccia con deviatore.
Single-lever bath/shower mixer with diverter (external components).



OX23612D2
 Miscelatore monocomando per doccia con deviatore a 2 posizioni su piastra unica.
Single-lever shower mixer, with 2 positions diverter on single flange.



OX23612D7
 Miscelatore monocomando per doccia con deviatore a tre vie e sette posizioni su unica piastra.
Single lever built-in shower mixer with three ways diverter with seven positions on single flange.



OX23612D3
 Miscelatore monocomando per doccia con deviatore a 3 vie e 3 posizioni, su unica piastra.
Single lever built-in shower mixer with 3 ways diverter and 3 positions, on single flange.



OX23612D4
 Miscelatore monocomando per doccia con deviatore a quattro vie (4 uscite 1 entrata) su piastra unica.
Single lever built-in shower mixer with four ways diverter (4 outlets and 1 inlet) on single flange.



OX23612D5
 Miscelatore monocomando per doccia, con deviatore a 5 vie (5 uscite ed una entrata) su piastra singola.
Single-lever shower mixer with 5 ways diverter (5 outlets and 1 inlet) on single flange.

BOX INCASSO - BUILT-IN BOX

OX23602KB

Set miscelatore doccia da abbinare al box incasso.
Shower mixer set to match with the built-in box.



+



DAN BOX

Box da incasso per miscelatore doccia con deviatore.
Built-in box for shower mixer with diverter.

FUSION

TOKYO

TOKYO
STEEL

OX23612KB

Set miscelatore doccia con deviatore da abbinare al box incasso.
Shower mixer set with diverter to match with the built-in box.



+



DAN BOX

Box da incasso per miscelatore doccia con deviatore.
Built-in box for shower mixer with diverter.

DIVA

DEKORA
SENSE

OX23612D2KB

Set miscelatore doccia due vie da abbinare al box incasso.
Two ways shower mixer set to match with the built-in box.



+



DAN BOXD2

Box da incasso per miscelatore doccia due vie.
Built-in box for two ways shower mixer.

SPEED

DEKORA
SENSE

TIARA

OX23612D3KB

Set miscelatore doccia tre vie da abbinare al box incasso.
Three ways shower mixer set to match with the built-in box.



+



DAN BOXD3

Box da incasso per miscelatore doccia tre vie.
Built-in box for three ways shower mixer.

SKYLINE

DEKORA
SENSE

SUVI

DEKORA
SENSE

OXY

DEKORA
SENSE

OX23612D7KB

Set miscelatore doccia tre vie e sette posizioni da abbinare al box incasso.
Three ways and seven positions shower mixer set to match with the built-in box.



+



DAN BOXD3

Box da incasso per miscelatore doccia tre vie.
Built-in box for three ways shower mixer.

JAX

KIR

TWIN

DEKORA
SENSE

BOCCHE - SPOUTS



Q4704
Bocca incasso, 18 cm.
Built-in spout, 18 cm.



Q4702
Bocca incasso con deviatore, 18 cm.
Built-in spout with diverter, 18 cm.



OX4704
Bocca incasso, 16,5 cm.
Built-in spout, 16,5 cm.



A740
Sifone squadrato in ottone cromato 1"1/4.
C.P. brass "Square" P trap 1"1/4.

WELLNESS



OX23613Z
Set doccia con soffione a pioggia quadrato 20x20 cm con getti anticalcare e braccio 30 cm, saliscendi lusso con doccetta ad 1 funzione, attacco presa acqua tipo quadrato pesante, miscelatore con deviatore 3 vie e 7 posizioni e 6 getti anticalcare. Tutto in ottone cromato.
Shower set with squared shower head 20x20 cm with antilimestone rain jet and arm 30 cm, deluxe sliding rail with hand shower 1 function, water punch connector squared and heavy type, shower mixer with 3 ways diverter and 7 positions and 6 jets antilimestone. All in c.p. brass.



OX23616Z
Set doccia con soffione a pioggia quadrato 20x20 cm con getti anticalcare e braccio 30 cm, doccetta ad 1 funzione con supporto/presa acqua snodato lusso quadrato, deviatore a 3 vie e 7 posizioni, 6 getti anticalcare. Tutto in ottone cromato.
Shower set with squared shower head 20x20 cm with antilimestone rain jet and arm 30 cm, hand shower 1 function with shower holder/water punch connector squared, with shower mixer 3 ways diverter and 7 positions, 6 jets antilimestone. All in c.p. brass.



OX23614Z
Set doccia con soffione a pioggia quadrato 20x20 cm con getti anticalcare e braccio 30 cm, saliscendi lusso con doccetta ad 1 funzione, attacco presa acqua tipo quadrato pesante, miscelatore incasso con deviatore. Tutto in ottone cromato.
Shower set with squared shower head 20x20 cm with antilimestone rain jet and arm 30 cm, deluxe sliding rail with hand shower 1 function, water punch connector squared and heavy type, built-in bath/shower mixer with diverter. All in c.p. brass.



OX23615Z
Set doccia con soffione a pioggia quadrato 20x20 cm con getti anticalcare e braccio 30 cm, doccetta ad 1 funzione con supporto/presa acqua snodato lusso quadrato, miscelatore incasso con deviatore. Tutto in ottone cromato.
Shower set with squared shower head 20x20 cm with antilimestone rain jet and arm 30 cm, hand shower 1 function with shower holder/water punch connector squared, Built-in bath/shower mixer with diverter. All in c.p. brass.



OX23617Z

Set doccia con soffione a pioggia quadrato 20x20 cm con getti anticalcare e braccio 30 cm, doccetta ad 1 funzione con supporto/presa acqua snodato lusso quadrato, miscelatore con deviatore 3 vie e 7 posizioni e bocca da parete. Tutto in ottone cromato.

Shower set with squared shower head 20x20 cm rain jet with antilimestone and arm 30 cm, hand shower 1 function with shower holder/water punch connector squared, shower mixer with 3 ways diverter and 7 positions, built-in spout. All in c.p. brass.



OX23619Z

Set doccia con colonna doccia con presa acqua incorporata con soffione a pioggia quadrato 20x20 cm con getti anticalcare e doccetta ad 1 funzione, miscelatore incasso con deviatore, bocca incasso. Tutto in ottone cromato.

Shower set with shower column with integrated water punch, squared shower head 20x20 cm rain jet with antilimestone, 1 function hand shower, built-in bath/shower mixer with diverter, built-in spout. All in c.p. brass.

FUSION

TOKYO

TOKYO
STEEL

DIVA
DEKORA
SENSE

SPEED
DEKORA
SENSE

TIARA

SKYLINE
DEKORA
SENSE

SUVI
DEKORA
SENSE

OXY
DEKORA
SENSE

JAX

KIR

TWIN
DEKORA
SENSE

CUCINA - KITCHEN



OX23609

Miscelatore lavello a muro con canna girevole.

Lunghezza canna: 22,5 cm.
Wall mounted single lever sink mixer with movable spout. Length spout: 22,5 cm.



OX23617

Monocomando lavello con canna girevole.

Altezza: 31 cm - Interasse: 22 cm.
Single-lever sink mixer with swiveling spout. Height: 31 cm - Interaxis: 22 cm.

ACQUA DEPURATA - PURIFIED WATER



OX23608DW

Miscelatore lavello a tre vie di ingresso, bocca girevole, con selezione acqua potabile tramite la leva, con 2 aeratori in uscita.

Altezza: 32 cm - Interasse: 21,8 cm.
Three ways inlet single lever sink mixer, with movable spout, with selection for drinking water directly from the lever, with 2 exit aerators. Height: 32 cm - Interaxis: 21,8 cm.





JAX

JAX è una collezione di rubinetteria bicomando dal design stilizzato e minimale. Le maniglie sono disponibili sia nella versione a croce (prefisso codice J) che nel modello ad asta singola TILLY (prefisso codice Y)

JAX is a double lever taps Collection with a stylized and minimal design. Handles are available both in the cross version (prefix code J) and in the single rod model TILLY (prefix code Y).

FINISHINGS

CP cromo spazzolato
brushed chrome

64 vecchio rame
old copper

DO oro lucido
shiny gold

GO grafite
graphite

NP nichel spazzolato
brushed nickel

14 bianco opaco
matt white

DP oro spazzolato
brushed gold

PP oro rosa spazzolato
brushed pink gold

FIN 2

NPO nichel spazzolato opaco
matt brushed nickel

15 nero opaco
matt black

FIN 4
FZ cromo nero spazzolato lucido
shiny brushed black chrome

63 vecchio ottone
old brass

CF cromo nero lucido
shiny black chrome

OIL oil bronze
oil bronze

RL rame lucido
shiny copper

FIN 5

PG oro rosa lucido
shiny pink gold

RPO rame anodizzato
anodised copper

Finiture consigliate per questa collezione.
Per l'elenco completo fare riferimento alla tabella delle finiture (pag.04)

*Suggested finishes for this collection.
For a complete list of available colors, please refer to the finishing table (page 04)*



ANIMA & DESIGN
SOUL & DESIGN

FUSION

TOKYO

TOKYO
STEEL

DIVA
DEKORA
SENSE

SPEED
DEKORA
SENSE

TIARA

SKYLINE

DEKORA
SENSE

SUVI
DEKORA
SENSE

OXY
DEKORA
SENSE

JAX

KIR

TWIN
DEKORA
SENSE



CARATTERISTICHE TECNICHE:

La serie è dotata di vitone ceramico, prodotto da S.T.S.R. - Studio Tecnico Sviluppo e Ricerche - www.stsr.it

TECHNICAL CHARACTERISTICS:

The series is equipped with ceramic headvalve, produced by S.T.S.R. - Research Development Technical Office - www.stsr.it



Disponibile anche con maniglia TILLY.
Available also with TILLY handle.

LAVABI E BIDET- WASHBASIN MIXERS AND BIDET



J5112

Monoforo lavabo con scarico (Non vendibile in Germania)
Altezza: 25,5 cm - Interasse: 13,5 cm.
One hole washbasin mixer with pop-up waste (Not saleable in Germany).
Height: 25,5 cm - Interaxis: 13,5 cm.



J5003

Batteria lavabo con scarico.
Altezza: 23,5 cm - Interasse: 13,5 cm.
Washbasin set with pop-up waste.
Height: 23,5 cm - Interaxis: 13,5 cm.



J5022

Batteria lavabo da incasso.
Lunghezza bocca: 20 cm.
Concealed basin mixer.
Length spout: 20 cm.



J5021

Batteria lavabo da incasso su piastra unica.
Lunghezza bocca: 20 cm.
Concealed basin mixer on single flange.
Length spout: 20 cm.



J6200

Monoforo bidet con scarico.
Altezza: 19,6 cm - Interasse: 14,5 cm.
One hole bidet mixer with pop-up waste.
Height: 19,6 cm - Interaxis: 14,5 cm.



J6302

Batteria bidet con scarico.
Altezza: 8,5 cm.
Three holes bidet set with pop-up waste.
Height: 8,5 cm.



J9200

Maniglia Jax.
Jax handle.



J4454

Rubinetto doccia incasso 1/2".
Built-in right valve 1/2".

MISCELATORI VASCA E DOCCIA - SHOWER AND BATH MIXERS



Gruppo vasca esterno.
Bathtub mixer.

J4302 con kit doccia, flessibile 150 cm.
with shower kit, flexible 150 cm.

J4300 con kit doccia, flessibile 120 cm.
with shower kit, flexible 120 cm.

J4300H senza kit doccia.
without shower kit.



J4492
Batteria bordo vasca quattro fori con canna con deviatore integrato nella bocca e doccetta estraibile in ottone cromato.
Four holes deck bath set with diverter integrated on the casted spout, and pull-out hand shower in c.p. brass.

FUSION

TOKYO

TOKYO
STEEL



J4491
Batteria bordo vasca cinque fori con deviatore, bocca e doccetta estraibile in ottone cromato.
Five holes deck bath set with diverter, casted spout, and pull-out hand shower in c.p. brass.

DIVA
DEKORA
SENSE

SPEED
DEKORA
SENSE



J4498
Batteria bordo vasca cinque fori con deviatore, bocca a cascata, doccetta estraibile in ottone cromato.
Five holes deck bath set with diverter, waterfall spout, and pull-out hand shower in c.p. brass.

TIARA



J4440
Batteria vasca incasso con deviatore, set doccia e bocca.
Built-in bathtub mixer with diverter, shower kit and spout.

SKYLINE
DEKORA
SENSE

SUVI
DEKORA
SENSE



J4441
Batteria vasca/doccia incasso con soffione con getto pioggia e braccio cm 30 tutto in ottone cromato, deviatore e set doccia.
Built-in bath/shower mixer, shower head and brass cm 30 all in c-p- brass, with diverter and shower kit.

OXY
DEKORA
SENSE



Gruppo doccia esterno.
Wall-mounted shower mixer.

J4433A con kit doccia.
with shower kit.

J4433 senza kit doccia.
without shower kit.

JAX

KIR

TWIN
DEKORA
SENSE



J4433Z
Gruppo doccia esterno, attacco 3/4 M per colonna doccia.
Wall mounted shower mixer with connection 3/4 M for columns.

COLONNE DOCCIA - SHOWER COLUMN



Saliscendi completamente in ottone cromato con doccetta cilindrica in ottone cromata.
Sliding rail set all in C.P. brass with handshower completely in brass.

A340 435

Saliscendi 70 cm.
Sliding rail 70 cm.

A394 435

Saliscendi 90 cm.
Sliding rail 90 cm.



J4437

Articolo J4433Z proposto con colonna doccia A250 e soffione tutto ottone A58625.
Article J4433Z with shower column A250 and shower head all brass A58625.



J4435

Articolo J4433Z proposto con colonna doccia A201, soffione tutto ottone A58625 e doccetta A435.
Article J4433Z with swivable sliding column A201, shower head all in brass A58625 and handshower A435.

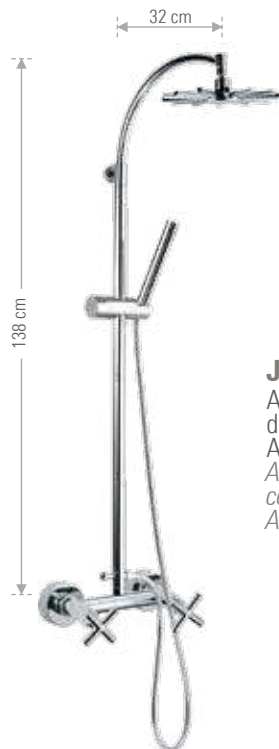

J4436

Articolo J4433Z proposto con colonna doccia A205, soffione tutto ottone A58625 e doccetta A435.
Article J4433Z with swivable sliding column A205, shower head all in brass A58625 and handshower A435.

CUCINA - KITCHEN



J7004

Gruppo lavello a muro con bocca girevole.
Interasse: 18,5 cm.
Wall mounted sink set with movable spout.
Interaxis: 18,5 cm



J7100

Monoforo lavello con bocca girevole.
Altezza: 30,5 cm - Interasse: 21 cm.
One-hole sink mixer with movable spout.
Height: 30,5 cm - Interaxis: 21 cm.



FUSION

TOKYO

TOKYO
STEEL

DIVA
DEKORA
SENSE

SPEED
DEKORA
SENSE

TIARA

SKYLINE
DEKORA
SENSE

SUVI
DEKORA
SENSE

OXY
DEKORA
SENSE

JAX

KIR

TWIN
DEKORA
SENSE



KIR

KIR è una collezione di miscelatori monocomando contraddistinta da un'eleganza classica e dall'utilizzo della cartuccia joystick. La leva si sviluppa in altezza ed il movimento joystick consente un controllo della miscelazione estremamente fluido e preciso.

KIR is a single-lever mixers collection characterized by a classic elegance and by the use of joystick cartridge. The lever is developed in height and the joystick movement allows an extremely fluid and precise mixing control.

FINISHINGS

FIN 2				
 CP cromo spazzolato brushed chrome	 NP nichel spazzolato brushed nickel	 NPO nichel spazzolato opaco matt brushed nickel	 63 vecchio ottone old brass	 OIL oil bronze oil bronze
 64 vecchio rame old copper	 14 bianco opaco matt white	 15 nero opaco matt black		
FIN 4				
 DO oro lucido shiny gold	 DP oro spazzolato brushed gold	 FZ cromo nero spazzolato lucido shiny brushed black chrome	 CF cromo nero lucido shiny black chrome	 RL rame lucido shiny copper
 GO grafite graphite				
FIN 5				
 PG oro rosa lucido shiny pink gold	 PP oro rosa spazzolato brushed pink gold	 RPO rame anodizzato anodised copper		

Finiture consigliate per questa collezione.
Per l'elenco completo fare riferimento alla tabella delle finiture (pag.04)

*Suggested finishes for this collection.
For a complete list of available colors, please refer to the finishing table (page 04)*



ANIMA & DESIGN
SOUL & DESIGN

FUSION

TOKYO

TOKYO
STEEL

DIVA
DEKORA
SENSE

SPEED
DEKORA
SENSE

TIARA

SKYLINE
DEKORA
SENSE

SUVI
DEKORA
SENSE

OXY
DEKORA
SENSE

JAX

KIR

TWIN
DEKORA
SENSE



KIR

CARATTERISTICHE TECNICHE:

La serie è dotata di cartuccia a joystick,
prodotta da S.T.S.R. - Studio Tecnico Sviluppo e Ricerche
www.stsr.it

TECHNICAL CHARACTERISTICS:

The series is equipped with joystick cartridge,
produced by S.T.S.R. - Research Development Technical Office
www.stsr.it



Disponibile maniglia con pomolo liscio.
Available handle with Smooth Knob.



Disponibile maniglia con pomolo zigrinato.
Available handle with Knurled Knob.

LAVABI E BIDET- WASHBASIN MIXERS AND BIDET



K18605

Miscelatore lavabo con scarico.
Altezza: 20,2 cm - Interasse: 10 cm.
Washbasin mixer with pop-up waste.
Height: 20,2 cm - Interaxis: 10 cm.



K18607

Miscelatore lavabo alto con scarico.
Altezza: 29 cm - Interasse: 10,5 cm.
High Washbasin mixer with pop-up waste.
Height: 29 cm - Interaxis: 10,5 cm.



K18607X

Miscelatore lavabo con scarico, per lavabo
alto da appoggio.
Altezza: 32 cm - Interasse: 19,5 cm.
*High washbasin mixer with pop-up waste,
for high basins.*
Height: 32 cm - Interaxis: 19,5 cm.



K18622

Miscelatore lavabo da incasso,
lunghezza bocca 19 cm.
*Concealed Washbasin mixer,
length spout 19 cm.*



K18604

Miscelatore bidet con scarico.
Altezza: 20,2 cm - Interasse: 10 cm.
Bidet mixer with pop-up waste.
Height: 20,2 cm - Interaxis: 10 cm.



MISCELATORI VASCA E DOCCIA - SHOWER AND BATH MIXERS



FUSION

TOKYO

TOKYO
STEEL

DIVA
DEKORA
SENSE

SPEED
DEKORA
SENSE

TIARA

SKYLINE

DEKORA
SENSE

SUVI
DEKORA
SENSE

OXY
DEKORA
SENSE

JAX

KIR

TWIN
DEKORA
SENSE



Miscelatore vasca esterno.
Exposed bath mixer.

K18610 con kit doccia, flessibile 150 cm.
with shower kit, flexible 150 cm.

K18600 con kit doccia, flessibile 120 cm.
with shower kit, flexible 120 cm.

K18600H senza kit doccia.
without shower kit.



K18611Z
Monocomando doccia esterno con attacco
3/4 M per colonna.
*Exposed shower mixer with connection 3/4
M for columns.*



K18691
Miscelatore monocomando bordo vasca
con deviatore integrato nella bocca.
*Single lever deck bath/shower mixer with
diverter integrated on the spout.*



K18611A con kit doccia.
with shower kit.

K18611 senza kit doccia.
without shower kit.

Miscelatore doccia
esterno con kit doccia.
*Exposed shower mixer
with shower kit.*

INCASSI DOCCIA E BOCCHIE - BUILT-IN MIXERS AND SPOUTS

**K18602**

Miscelatore doccia incasso.
Single-lever Built-in shower mixer.

**K18612**

Miscelatore vasca incasso con deviatore.
Built-in bath/shower mixer with diverter.

**K4704**

Bocca incasso, 18 cm.
Built-in spout, 18 cm.

**K4702**

Bocca incasso vasca-doccia con deviatore integrato, 18 cm.
Built-in spout for bath-shower, with diverter, 18 cm.

COLONNE DOCCIA - SHOWER COLUMN

**K18636**

Miscelatore doccia esterno con deviatore integrato con colonna saliscendi con doccia anticalcare, flessibile e soffione ultrapiatto cromato.
Exposed single-lever shower mixer with diverter, with sliding column, anti-limestone handshower and extra-flat shower head.

**A340 435**

Saliscendi con doccetta anticalcare.
Altezza: 70 cm.
Sliding rail set with anti-limestone handshower.
Height: 70 cm.

CUCINA - KITCHEN



K18608

Monocomando lavello con canna girevole.
Altezza: 30,5 cm - Interasse: 19,5 cm.
*Single-lever sink mixer with swiveling spout.
Height: 30,5 cm - Interaxis: 19,5 cm.*



K18613

Miscelatore monocomando lavello con doccia estraibile.
Altezza: 30,5 cm - Interasse: 21 cm.
*Single-lever sink mixer with pull-out spray-jet shower.
Height: 30,5 cm - Interaxis: 21 cm.*



FUSION

TOKYO

TOKYO
STEEL

DIVA
DEKORA
SENSE

SPEED
DEKORA
SENSE

TIARA

SKYLINE
DEKORA
SENSE

SUVI
DEKORA
SENSE

OXY
DEKORA
SENSE

JAX

KIR

TWIN
DEKORA
SENSE



TWIN

La collezione TWIN rivisita il concetto della rubinetteria bi-comando in chiave moderna, portando l'erogazione tradizionale nel mondo dell'alto design. Una sofisticata eleganza che riassume minimalismo, stile e tecnologia produttiva.

The TWIN collection revisits the concept of double-lever taps in a modern key, bringing the traditional water supply into the high design world. A sophisticated elegance summarizing minimalism, style and production technology.



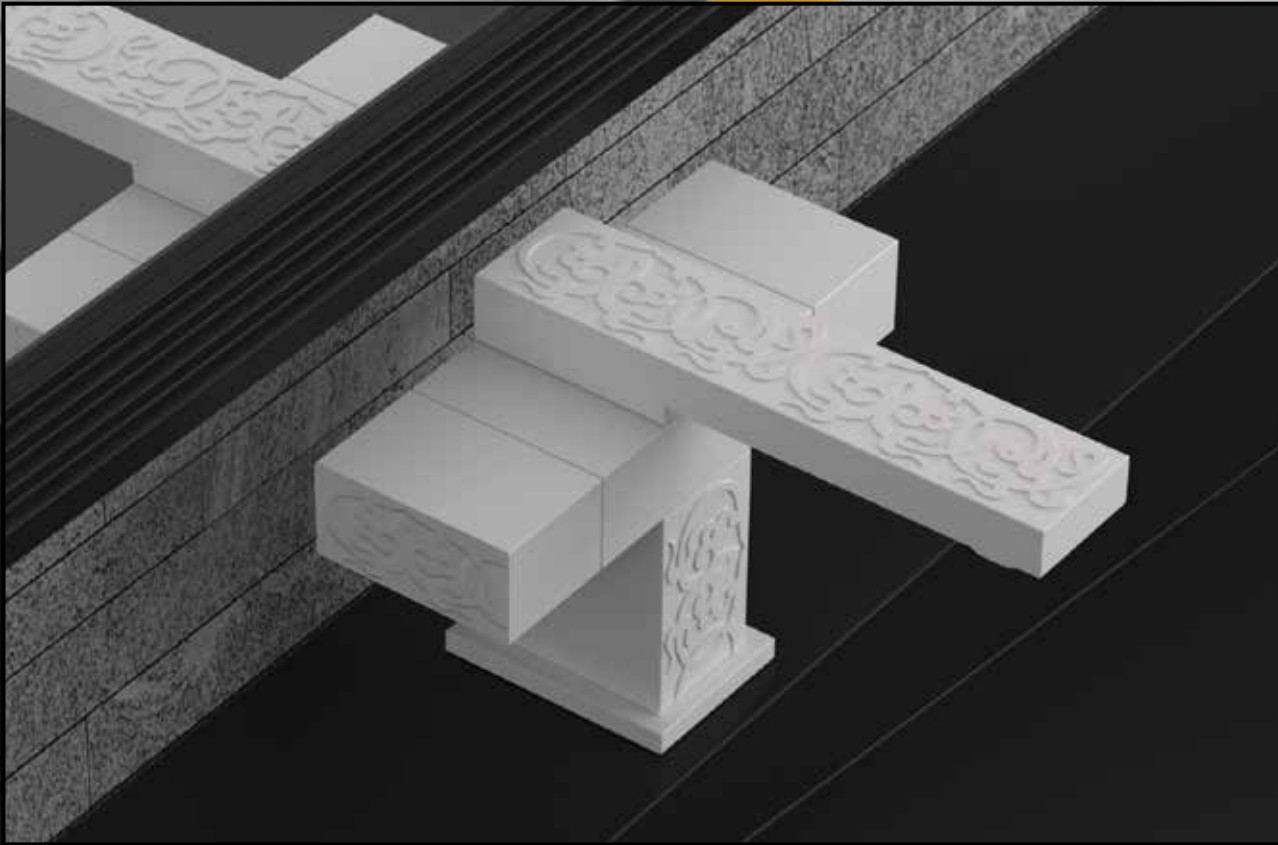

FUSION

TOKYO

TOKYO
STEEL

DIVA
DEKORA
SENSE

SPEED
DEKORA
SENSE

TIARA

SKYLINE

DEKORA
SENSE

SUVI

DEKORA
SENSE

OXY

DEKORA
SENSE

JAX

KIR

TWIN
DEKORA
SENSE

FINISHINGS

FIN 2					
CP cromo spazzolato brushed chrome	NP nichel spazzolato brushed nickel	NPO nichel spazzolato opaco matt brushed nickel	63 vecchio ottone old brass	OIL oil bronze oil bronze	
64 vecchio rame old copper	14 bianco opaco matt white	15 nero opaco matt black			
FIN 4					
DO oro lucido shiny gold	DP oro spazzolato brushed gold	RL rame lucido shiny copper	FZ cromo nero spazzolato lucido shiny brushed black chrome	CF cromo nero lucido shiny black chrome	GO grafite graphite
FIN 5					
PG oro rosa lucido shiny pink gold	PP oro rosa spazzolato brushed pink gold	RPO rame anodizzato anodised copper			

Finiture consigliate per questa collezione.
Per l'elenco completo fare riferimento alla tabella delle finiture (pag.04)

*Suggested finishes for this collection.
For a complete list of available colors, please refer to the finishing table (page 04)*

DECORI DISPONIBILI:
AVAILABLE DECORATIONS: FANTASY **YG**

DECO 1

YG81 cromo lucido, decoro oro spazzolato.
shiny chrome, brushed gold decoration

DECO 2

YG84 nichel spazzolato, decoro cromo lucido.
brushed nickel, shiny chrome decoration.

YG86 nichel spazzolato, decoro canna di fucile spazzolato.
brushed nickel, brushed gun barrel decoration.

YG97 nichel spazzolato, decoro nichel lucido.
brushed nickel, shiny nickel decoration,

DECO 4

YG87 corpo nichel spazzolato, decoro oro lucido.
body brushed nickel, shiny gold decoration.

YG95 canna di fucile spazzolato, decoro cromo.
brushed gun barrel, chrome decoration.

YG98 ottone spazzolato decoro ottone lucido.
brushed brass shiny brass decoration.

DECO 5

YG82 oro lucido, decoro oro spazzolato.
shiny gold, brushed gold decoration.

YG83 oro lucido, decoro nichel spazzolato.
shiny gold, brushed nickel decoration.

YG88 oro antico, decoro canna di fucile spazzolato.
antique gold, brushed gun barrel decoration.

YG96 oro spazzolato, decoro cromo.
brushed gold, chrome decoration.

DECO 6

YG14 Bianco Opaco
Matt White

YG15 Nero Opaco
Matt Black

DEKORA

SENSE

CARATTERISTICHE TECNICHE:

La serie è dotata di vitone ceramico,
prodotto da S.T.S.R. – Studio Tecnico Sviluppo e Ricerche,
www.stsr.it

TECHNICAL CHARACTERISTICS:

The series is equipped with ceramic head valves,
produced by S.T.S.R. - Research Development Technical Office,
www.stsr.it

LAVABI E BIDET - WASHBASIN MIXERS AND BIDET



W5116S

Monoforo lavabo con bocca corta e girevole e scarico.
Altezza: 27 cm - Interasse: 20,5 cm.
One hole washbasin with short and swiveling spout and pop-up waste.
Height: 27 cm - Interaxis: 20,5 cm.



W5003

Batteria lavabo con scarico.
Altezza: 12,5 cm - Interasse: 11,2 cm.
Washbasin set with pop-up waste.
Height: 12,5 cm - Interaxis: 11,2 cm.



Monoforo lavabo con bocca girevole.
Altezza: 37,5 cm - Interasse: 20,5 cm
One hole high washbasin mixer with swiveling spout.
Height: 37,5 cm - Interaxis: 20,5 cm.

W5116

con scarico.
with pop-up waste.



W5022

Batteria lavabo da incasso.
Lunghezza bocca: 18 cm.
Concealed basin mixer.
Length spout: 18 cm.

W5116CC

con scarico click-clack e troppo pieno.
with click-clack waste and overflow.



W5116LS

Monoforo lavabo con bocca corta girevole e scarico.
Altezza: 37 cm - Interasse: 20,5 cm.
One hole washbasin mixer with short and swiveling spout and pop-up waste.
Height: 37 cm - Interaxis: 20,5 cm.



W5112

con scarico.
with pop-up waste.

W5112CC

con scarico click-clack e troppo pieno.
with click-clack waste and overflow.

W5110

senza scarico.
without waste.

Monoforo lavabo.
Altezza: 11 cm - Interasse: 10,9 cm
One hole washbasin mixer.
Height: 11 cm - Interaxis: 10,9 cm.



FUSION

TOKYO

TOKYO
STEEL

DIVA
DEKORA
SENSE

SPEED
DEKORA
SENSE

TIARA

SKYLINE
DEKORA
SENSE

SUVI
DEKORA
SENSE

OXY
DEKORA
SENSE

JAX

KIR

TWIN
DEKORA
SENSE



W5188

Miscelatore monocomando lavabo da pavimento con click-clack e troppo pieno.
Altezza bocca: 95 cm - Interasse: 18,7 cm.
Single-lever mixer floor mounting with click-clack and overflow.
Height spout: 95 cm - Interaxis: 18,7 cm.



Monoforo lavabo alto.
Altezza: 21 cm - Interasse: 16,2 cm
One hole high washbasin mixer.
Height: 21 cm - Interaxis: 16,2 cm.

W5112L con scarico.
with pop-up waste.

W5112LCC con scarico click-clack e troppo pieno.
with click-clack waste and overflow.



Monoforo bidet.
Altezza: 10,5 cm
One hole bidet mixer.
Height: 10,5 cm

W6200 con scarico.
with pop-up waste.

W6200CC con scarico click-clack e troppo pieno.
with click-clack waste and overflow.

W6210 senza scarico.
without waste.

MISCELATORI VASCA E DOCCIA - SHOWER AND BATH MIXERS



Miscelatore vasca esterno.
Exposed bath mixer.

W4302 con kit doccia, flessibile 150 cm.
with shower kit, flexible 150 cm.

W4300 con kit doccia, flessibile 120 cm.
with shower kit, flexible 120 cm.

W4300H senza kit doccia.
without shower kit.



W4378

Miscelatore vasca da pavimento con
deviatore e kit doccia.
Altezza bocca: 85 cm - Interasse: 18,7 cm.
*Free standing bath mixer floor mounting
with diverter and shower kit.
Height spout: 85 cm - Interaxis: 18,7 cm.*

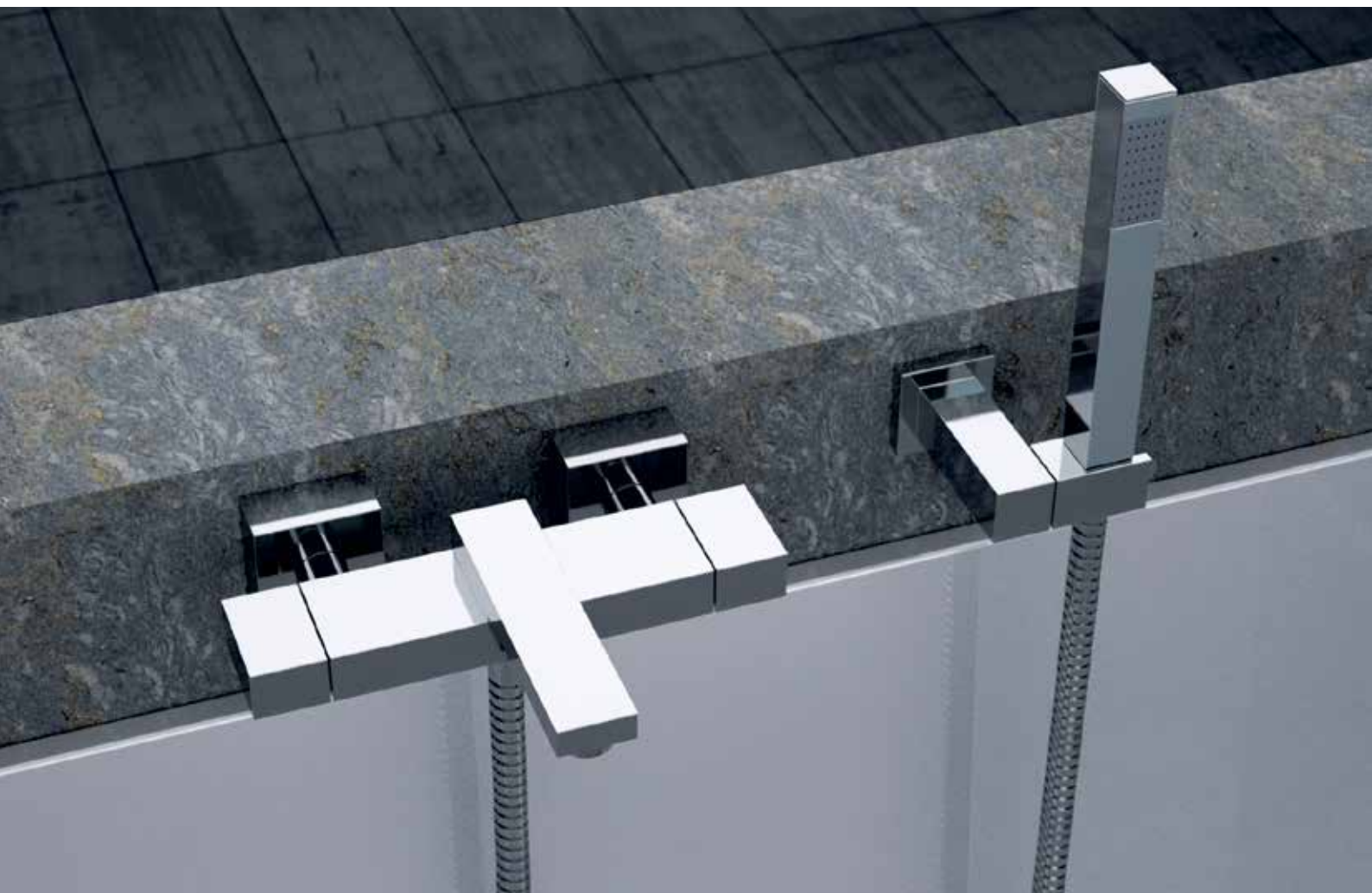



W4440
Batteria vasca incasso con set doccia.
Built-in bathtub mixer with shower kit.



W4192
Batteria bordo vasca con doccia estraibile.
Bathtub set with pull-out shower.



Gruppo doccia esterno.
Wall-mounted shower mixer.

W4433A con kit doccia.
with shower kit.

W4433 senza kit doccia.
without shower kit.



A355 495
Saliscendi lusso ultra piatto con asta rettangolare piatta con doccetta ad 1 funzione tutto in ottone.
Altezza: 70 cm, Deluxe sliding rail Twin extra flat completely in c.p. brass, rectangular extra flat rod, with 1 function hand shower all in c.p. brass. Altezza: 70 cm.

FUSION

TOKYO

TOKYO
STEEL

DIVA
DEKORA
SENSE

SPEED
DEKORA
SENSE

TIARA

SKYLINE
DEKORA
SENSE

SUVI
DEKORA
SENSE

OXY
DEKORA
SENSE

JAX

KIR

TWIN
DEKORA
SENSE

BOCCHIE E COMPONENTI - SPOUTS AND COMPONENTS



CA4704
Bocca incasso a cascata.
Built-in spout with waterfall jet.



W4704
Bocca incasso, 18 cm.
Built-in spout, 18 cm.



W9200
Maniglia Twin.
Twin handle.



W4454
Rubinetto doccia incasso 1/2".
Built-in right valve 1/2".



A590CA

Soffione doccia con getto a cascata.
C.p. Brass shower head with waterfall jet.



W4433Z

Gruppo doccia esterno con attacco 3/4 M per colonna.
Wall mounted shower mixer with connection 3/4 M for columns.

COLONNE DOCCIA - SHOWER COLUMN



W4437R

Corpo doccia con colonna e soffione tutto in ottone cromato.
Exposed shower mixer with shower column and shower head all in brass.



W4436R

Corpo doccia con colonna e soffione in ottone cromato, doccetta ad 1 funzione.
Exposed shower mixer with shower column and shower head all in brass, 1 function handshower.

WELLNESS



W4442

Set doccia con soffione a pioggia rettangolare 24x14 cm con getti in silicone anticalcare e braccio 30 cm, saliscendi lusso ultra piatto con asta rettangolare con doccetta ultrapiatta, attacco presa acqua, tipo quadrato, pesante, batteria doccia incasso con deviatore. Tutto in ottone cromato.
Shower kit with rectangular shower head 24x14 cm with rain jet antilimescale and arm 30 cm, deluxe sliding rail extra flat rectangular rod with hand shower extra flat, wall water punch connector, squared and heavy type, built-in bathtub with diverter. All in c.p. brass.



W4442CA

Set doccia con soffione a cascata, saliscendi lusso ultra piatto con asta rettangolare con doccetta ultrapiatta, attacco presa acqua tipo quadrato pesante, batteria doccia incasso con deviatore. Tutto in ottone cromato.
Shower kit with shower head with waterfall jet, deluxe sliding rail extra flat rectangular rod with hand shower extra flat, wall water punch connector squared and heavy type, built-in bathtub with diverter. All in c.p. brass.

W4441



Set doccia con soffione a pioggia rettangolare 24x14 cm con getti in silicone anticalcare e braccio 30 cm, doccetta quadrata ad 1 funzione, supporto snodato lusso presa acqua quadrato per incasso, batteria doccia incasso con deviatore. Tutto in ottone cromato.
Shower kit with rectangular shower head 24x14 cm with rain jet antilimestone and arm 30 cm, 1 function square handshower, adjustable shower holder/water punch squared, built-in shower with diverter. All in c.p. brass.

W4441CA



Set doccia con soffione a cascata, doccetta quadrata ad 1 funzione, supporto snodato lusso presa acqua quadrato per incasso, batteria doccia incasso con deviatore. Tutto in ottone cromato.
Shower kit with shower head with waterfall jet, 1 function square handshower, adjustable shower holder/water punch squared, built-in shower with diverter. All in c.p. brass.

FUSION

TOKYO

TOKYO
STEEL

CUCINA - KITCHEN

W7004



Gruppo lavello a muro con canna girevole.
Lunghezza canna: 22,5 cm.
*Wall mounted sink set with movable spout.
Lenght Spout: 22,5 cm.*

W7100



Monoforo lavello con bocca girevole.
Altezza: 37,5 cm - Interasse: 20,5 cm.
*One hole sink mixer with swiveling spout.
Height: 27,5 cm - Interaxis: 20,5 cm.*

DIVA
DEKORA
SENSE

SPEED
DEKORA
SENSE

TIARA

SKYLINE
DEKORA
SENSE

SUVI
DEKORA
SENSE

OXY
DEKORA
SENSE

JAX

KIR

TWIN
DEKORA
SENSE





OMEGA

Le linee dolci e tondeggianti della collezione OMEGA si intervallano a superfici piatte e riflettenti, tracciando un netto parallelismo tra la bocca e leva del miscelatore e definendo i profili di un'estetica essenziale. Una serie curata in ogni dettaglio, come ad esempio il tettuccio di protezione dell'aeratore nel miscelatore da bidet, in grado di soddisfare le esigenze di stile anche nei progetti a budget contenuto.
Design by Cristian Mapelli

The soft and round lines of OMEGA collection alternate with flat and reflective surfaces, drawing a clear parallel between spout and mixer lever and defining the essential aesthetics profiles. A series with attention to every detail, such as the aerator protection shield in bidet mixer, able to satisfy the style demands even in low budget projects.
Design by Cristian Mapelli

FINISHINGS

CP cromo spazzolato
brushed chrome

64 vecchio rame
old copper

DO oro lucido
shiny gold

GO grafite
graphite

PG oro rosa lucido
shiny pink gold

NP nichel spazzolato
brushed nickel

14 bianco opaco
matt white

DP oro spazzolato
brushed gold

PP oro rosa spazzolato
brushed pink gold

FIN 2

NPO nichel spazzolato opaco
matt brushed nickel

15 nero opaco
matt black

FZ cromo nero spazzolato lucido
shiny brushed black chrome

RPO rame anodizzato
anodised copper

63 vecchio ottone
old brass

OIL oil bronze
oil bronze

FIN 4

CF cromo nero lucido
shiny black chrome

RL rame lucido
shiny copper

FIN 5

Finiture consigliate per questa collezione.
Per l'elenco completo fare riferimento alla tabella delle finiture (pag.04)

Suggested finishes for this collection.
For a complete list of available colors, please refer to the finishing table (page 04)

CONTEMPORANEO
CONTEMPORARY

OMEGA

SMART

OMEGA

ECO

SMART

ECO



CARATTERISTICHE TECNICHE:

La serie è dotata di cartuccia a dischi ceramici Ø 35 mm, prodotta da S.T.S.R. Studio Tecnico Sviluppo e Ricerche www.stsr.it

TECHNICAL CHARACTERISTICS:

The series is equipped with ceramic cartridge Ø 35 mm, produced by S.T.S.R. - Research Development Technical Office www.stsr.it

LAVABI - WASHBASIN MIXERS



Monocomando lavabo.
Altezza: 15 cm - Interasse: 11 cm.
*Single-lever basin mixer.
Height: 15 cm - Interaxis: 11 cm.*

OM605

con scarico.
with pop-up waste.

OM606

senza scarico
without waste.

OM606N

senza scarico e senza foro sul corpo
without waste and without body hole.



Monocomando lavabo alto.
Altezza: 17 cm - Interasse: 13 cm.
*High basin mixer.
Height: 17 cm - Interaxis: 13 cm.*

OM607

con scarico.
with pop-up waste.

OM607B

senza scarico
without waste.

OM607BN

senza scarico e senza foro sul corpo
without waste and without body hole.



Monocomando lavabo XL.
Altezza: 30,6 cm - Interasse: 18 cm.
*XL basin mixer.
Height: 30,6 cm - Interaxis: 18 cm.*

OM607X

con scarico click-clack.
with click-clack waste.

OM607XB

senza scarico
without waste.



OM655
Miscelatore monocomando lavabo a due fori.
Altezza: 23,2 cm - Interasse: 17,2 cm.
*Two holes built-in basin mixer.
Height: 23,2 cm - Interaxis: 17,2 cm.*

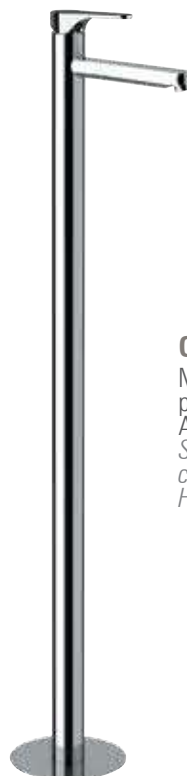

OM688

Miscelatore monocomando lavabo da pavimento con click-clack e troppo pieno.
Altezza bocca: 93 cm - Interasse: 18,7 cm.
*Single-lever mixer floor mounting with click-clack and overflow
Height spout: 93 cm - Interaxis: 18,7 cm.*



OM634

Miscelatore monocomando a incasso per lavabo, con piastra rettangolare verticale.
Lunghezza bocca: 18 cm.
*Single-lever built-in basin mixer, with vertical rectangular wall flange.
Lenght spout: 18 cm.*



OM632

Miscelatore monocomando a incasso per lavabo, con piastra rettangolare.
Lunghezza bocca: 18 cm.
*Single-lever built-in basin mixer, with rectangular wall flange.
Lenght spout: 18 cm.*

OMEGA

SMART

OMEGA

ECO

SMART

ECO



LAVABO BOX INCASSO - BUILT-IN BOX WASHBASIN MIXER

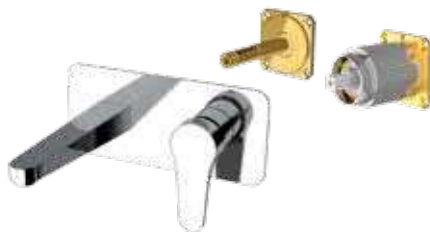

OM632KB

Miscelatore monocomando a incasso per lavabo, con piastra in ottone cromato, bocca lunghezza 18 cm, da abbinare al box incasso.
Single-lever built-in basin mixer, with wall flange in chrome plated brass, spout lenght 18 cm, to match with the built-in box.

+



DAN BOX632

Box da incasso per miscelatore monocomando a incasso per lavabo.
Built-in box for single-lever built-in basin mixer.



Miscelatore bidet.
Altezza: 13 cm - Interasse: 10,5 cm.
Bidet mixer.
Height: 13 cm - Interaxis: 10,5 cm.

OM604

con scarico.
with pop-up waste.

OM604B

senza scarico
without waste.



Miscelatore incasso per shut-off serie Omega
su piastra in ottone cromato.
*Omega model built-in shower mixer all in c.p.
brass.*

OM645

comprendivo di doccetta shut-off art. 1000DC,
supporto doccia-presa acqua, tutto in ottone
cromato e flessibile doccia cm 120.
*including shut-off art. 1000DC, shower holder-
water punch on flange, all in c.p. brass and
shower flexible cm 120.*

OM645H

senza kit shut-off.
without shut-off set.



OM646

Miscelatore incasso per shut-off.
Built-in shut-off mixer.



OM642

Miscelatore incasso per shut-off con doccetta
shut-off, supporto doccia, presa acqua.
*Built-in shut-off mixer set shut-off, shower
holder, water punch.*



OM605SH4DC

Miscelatore monocomando lavabo con
doccia shut-off e scarico click-clack con
troppo pieno.
*Single-lever basin mixer with shut-off
handshower and click-clack pop-up waste
with overflow.*

MISCELATORI VASCA E DOCCIA - BATH & SHOWER MIXERS

CONTEMPORANEO
CONTEMPORARY

OMEGA

SMART

OMEGA

ECO

SMART

ECO



Miscelatore vasca esterno.
Exposed bath mixer.

OM610

con kit doccia, flessibile 150 cm.
with shower kit, flexible 150 cm.

OM600H

senza kit doccia.
without shower kit.



OM678

Miscelatore vasca da pavimento con deviatore e kit doccia.

Altezza bocca: 78 cm max. - Interasse: 20,1 cm.
Free standing bath mixer floor mounting with diverter and shower kit.
Height spout: 78 cm max. - Interaxis: 20,1 cm.



OMEGA



OM691

Miscelatore monocomando bordo vasca.
Single lever deck bath/shower mixer.



OM699

Miscelatore monocomando bordo vasca con bocca multigetto.
Single lever deck bath/shower mixer with multijet spout.



Monocomando doccia esterno.
Exposed shower mixer.

OM611A

con kit doccia
with shower kit

OM611

senza kit doccia.
without shower kit.



Miscelatore lavabo/vasca con canna fusa lunga e con deviatore.
Wall basin/bath single lever mixer with long casted spout and diverter.

OM624

con kit doccia
with shower kit

OM624H

senza kit doccia.
without shower kit.





Miscelatore monocomando per vasca.
Single lever bath mixer.

OM606D

con deviatore integrato e kit doccia..
with diverter and shower kit.

OM606DH

senza kit doccia.
without shower kit.



Miscelatore vasca/doccia.
Bath/shower mixer.

OM600DH

con attacco alto da 1/2" ed attacco inferiore da 1/2".
with upper 1/2" connection and lower connection 1/2".

OM600DH34

con attacco alto da 3/4" ed attacco inferiore da 1/2".
with upper 3/4" connection and lower connection 1/2".



OM636DA7820

Miscelatore vasca/doccia con attacco alto da 3-4" ed attacco inferiore da 1/2", con colonna doccia telescopica, doccetta anticalcare a 4 funzioni, con flessibile A505X 150 cm e soffione ultrapiatto Ø 20 cm, in acciaio inox lucidato a specchio con getti in silicone anticalcare.
Bath/shower mixer with upper 3/4" connection and lower connection 1/2", with telescopic shower column, c.p. handshower 4 functions antilimestone, with A505X 150 cm flexible hose and ultra slim stainless steel mirror polished shower head Ø 20 cm, with anti-limestone silicon jets.



OM636DA8420

Miscelatore vasca/doccia con attacco alto da 3-4" ed attacco inferiore da 1/2", con colonna doccia telescopica, doccetta anticalcare a 4 funzioni, con flessibile A505X 150 cm e soffione a pioggia in ABS cromato, Ø 20 cm, con getti in silicone autopulenti.
Bath/shower mixer with upper 3/4" connection and lower connection 1/2", with telescopic shower column, c.p. handshower 4 functions antilimestone, with A505X 150 cm flexible hose and c.p. ABS shower head rain jets, Ø 20 cm, with selfcleaning silicon jets.

BOCCHIE - SPOUTS



OM4704

Bocca incasso, 18 cm.
Built-in spout, 18 cm.



OM4702

Bocca incasso con deviatore, 18 cm.
Built-in spout with diverter, 18 cm.



F4705

Bocca bordo vasca con effetto multigetto.
Spout with multijet effect for deck bath/shower mixer.

INCASSI DOCCIA - BUILT-IN MIXERS



OM602B
Miscelatore doccia incasso.
Built-in shower mixer.



OM612B
Miscelatore vasca incasso con deviatore.
Built-in bath/shower mixer with diverter.



OM602
Monocomando doccia incasso.
Built-in shower mixer.



OM612
Monocomando vasca incasso con deviatore.
Built-in bath/shower mixer with diverter.

IN602C35 Parte interna miscelatore monocomando incasso doccia.
Single-lever shower mixer (built-in components).

IN612C35 Parte interna miscelatore monocomando incasso vasca/doccia con deviatore.
Single-lever bath/shower mixer with diverter (built-in components).

OM602EKIT Parte esterna miscelatore monocomando incasso doccia.
Single-lever shower mixer (external components).

OM612EKIT Parte esterna miscelatore monocomando incasso vasca/doccia con deviatore.
Single-lever bath/shower mixer with diverter (external components).



OM612D2
Miscelatore monocomando per doccia con deviatore a 2 vie su piastra unica.
Single-lever shower mixer, with 2 ways diverter on single flange.



OM612D3
Miscelatore monocomando per doccia con deviatore a 3 vie e 3 posizioni (una entrata e tre uscite), su unica piastra.
Single lever built-in shower mixer with 3 ways diverter and 3 positions (1 inlet and 3 outlets), on single flange.



OM612D4
Miscelatore monocomando per doccia con deviatore a quattro vie (4 uscite ed 1 entrata) su piastra unica.
Single lever built-in shower mixer with four ways diverter (4 outlets and 1 inlet) on single flange.



OM612D5
Miscelatore monocomando per doccia, con deviatore a 5 vie (5 uscite ed una entrata) su piastra singola.
Single-lever shower mixer with 5 ways diverter (5 outlets and 1 inlet) on single flange.



OM612D7
Miscelatore monocomando per doccia con deviatore a 3 vie e 7 posizioni su unica piastra.
Single lever built-in shower mixer with 3 ways diverter with 7n positions on single flange.

BOX INCASSO - BUILT-IN BOX

OM602KB

Set miscelatore doccia da abbinare al box incasso.
Shower mixer set to match with the built-in box.



+



DAN BOX

Box da incasso per miscelatore doccia con deviatore.
Built-in box for shower mixer with diverter.

OM612KB

Set miscelatore doccia con deviatore da abbinare al box incasso.
Shower mixer set with diverter to match with the built-in box.



+



DAN BOX

Box da incasso per miscelatore doccia con deviatore.
Built-in box for shower mixer with diverter.

OM612D2KB

Set miscelatore doccia due vie da abbinare al box incasso.
Two ways shower mixer set to match with the built-in box.



+



DAN BOXD2

Box da incasso per miscelatore doccia due vie.
Built-in box for two ways shower mixer.

OM612D3KB

Set miscelatore doccia tre vie da abbinare al box incasso.
Three ways shower mixer set to match with the built-in box.



+



DAN BOXD3

Box da incasso per miscelatore doccia tre vie.
Built-in box for three ways shower mixer.

OM612D7KB

Set miscelatore doccia tre vie e sette posizioni da abbinare al box incasso.
Three ways and seven positions shower mixer set to match with the built-in box.



+



DAN BOXD3

Box da incasso per miscelatore doccia tre vie.
Built-in box for three ways shower mixer.

OMEGA

SMART

OMEGA

ECO

SMART

ECO

WELLNESS



OM614Z

Set doccia composto da soffione anticalcare minimale in ABS lusso Ø 20 cm con braccio in ottone cromato 30 cm, miscelatore vasca/doccia incasso con deviatore su piastra Omega, saliscendi minimale con doccetta in ABS cromato anticalcare a 1 funzione, attacco presa acqua da 1/2 tipo rotondo pesante.

Shower set composed of minimal deluxe antilimestone ABS shower head Ø 20 cm with c.p. brass arm 30 cm, built-in bath/shower mixer with diverter with Omega Plate, Minimal sliding rail set with 1 function c.p. ABS anti-limestone handshower, brass wall connector, round heavy type.



OM615Z

Set doccia composto da soffione minimale anticalcare in ABS lusso Ø 20 cm con braccio in ottone cromato 30 cm, miscelatore vasca/doccia incasso con deviatore su piastra Omega, doccetta anticalcare in ABS cromato ad 1 funzione con supporto doccia presa acqua lusso e flessibile 150 cm.

Shower set composed of minimal deluxe ABS shower head Ø 20 cm with arm cm 30, built-in bath/shower mixer with diverter with Omega Plate, 1 function antilimestone c.p. ABS hand shower with shower holder/water punch and flexible hose 150 cm.



OM614ZO

Set doccia composto da soffione anticalcare Ø 20 cm con braccio 30 cm, miscelatore vasca/doccia incasso con deviatore su piastra Omega, saliscendi minimale con doccetta ad 1 funzione, attacco presa acqua da 1/2 tipo rotondo pesante. Tutto in ottone cromato

Shower set composed of antilimestone shower head Ø 20 cm with arm 30 cm, built-in bath/shower mixer with diverter with Omega Plate, Minimal sliding rail set with 1 function handshower, brass wall connector, round heavy type. All in c.p. brass.



OM615ZO

Set doccia composto da soffione anticalcare Ø 20 cm con braccio 30 cm, miscelatore vasca incasso con deviatore su piastra Omega, doccetta ad 1 funzione con supporto presa acqua. Tutto in ottone cromato.

Shower set composed of shower head Ø 20 cm with arm 30 cm, built-in bath/shower mixer with diverter on Omega Plate, 1 function handshower with shower holder/water punch. All in c.p. brass.

CUCINA - KITCHEN



OM618

Miscelatore lavello monoforo 90° con canna alta girevole.

Altezza: 33,5 cm - Interasse: 17,5 cm.

Single-lever sink mixer 90° with high movable spout.

Height: 33,5 cm - Interaxis: 17,5 cm.



OM618C

Miscelatore lavello monoforo 90° con canna alta girevole, modello corto.

Altezza: 30 cm - Interasse: 12 cm.

Single-lever sink mixer 90° with high movable spout, short type.

Height: 30 cm - Interaxis: 12 cm.



OM617

Miscelatore lavello monoforo 45° con canna alta "U" girevole.

Altezza: 27 cm - Interasse: 22 cm.

Single-lever sink mixer 45° with high movable "U" spout.

Height: 27 cm - Interaxis: 22 cm.



OM614R

Miscelatore monocomando per lavello, con bocca alta girevole, tipo lusso.

Altezza: 29 cm - Interasse: 19,5 cm.

Single-lever one-hole sink mixer, with high movable spout, luxury type.

Height: 29 cm - Interaxis: 19,5 cm.



OM614B

Miscelatore monocomando per lavello, con bocca alta girevole.

Altezza: 30 cm - Interasse: 17 cm.

Single-lever one-hole sink mixer, with high movable spout.

Height: 30 cm - Interaxis: 17 cm.



OM614BC

Miscelatore monocomando per lavello, con canna corta girevole.

Altezza: 26 cm - Interasse: 12,5 cm.

Single-lever one-hole sink mixer, with short movable spout.

Height: 26 cm - Interaxis: 12,5 cm.



OM689

Miscelatore lavello monocomando a molla con doccetta estraibile ed orientabile a due funzioni e cartuccia Ø35 mm.

Altezza: 48 cm - Interasse: 21,5 cm.

Spring single-lever sink mixer with pull-out and swivelling 2 functions hand shower and Ø35 mm cartridge.

Height: 48 cm - Interaxis: 21,5 cm.



OM233

Miscelatore lavello monocomando a molla "fine design" girevole a 360° con doccetta estraibile ed orientabile a due funzioni e cartuccia Ø35 mm.

Altezza: 40,7 cm - Interasse: 21 cm.

Single-lever sink mixer with black flexible hose coated with "fine design" spring, 360° movable, with pull-out and swivelling 2 functions hand shower and Ø35 mm cartridge.

Height: 40,7 cm - Interaxis: 21 cm.





OM633
 Miscelatore lavello a muro, con leva frontale e bocca girevole.
 Altezza: 20 cm - Interasse: 19 cm.
Single-lever wall mounted sink mixer with frontal lever and movable spout.
 Height: 20 cm - Interaxis: 19 cm.



OM633B
 Miscelatore lavello a muro, con leva frontale e canna alta girevole.
 Altezza: 28 cm - Interasse: 17 cm.
Single-lever wall mounted sink mixer with frontal lever and high movable spout.
 Height: 28 cm - Interaxis: 17 cm.



OM609T
 Miscelatore lavello a muro con canna girevole.
 Lunghezza canna: 20 cm.
Wall-mounted single-lever sink mixer with movable spout.
 Length spout: 20 cm.



OM609S
 Miscelatore lavello a muro con bocca ad "S" girevole.
 Lunghezza canna: 20 cm.
Wall-mounted single-lever sink mixer with "S" movable spout.
 Length spout: 20 cm.



OM614T
 Miscelatore lavello monoforo 45° con bocca alta girevole.
 Altezza: 27 cm - Interasse: 18 cm.
Single-lever sink mixer 45° with high movable spout.
 Height: 27 cm - Interaxis: 18 cm.



OM614C
 Miscelatore lavello monoforo 45° con canna fusa corta.
 Altezza: 21 cm - Interasse: 12 cm.
Single-lever sink mixer 45° with short movable casted spout.
 Height: 21 cm - Interaxis: 12 cm.



OM614TC
 Miscelatore lavello monoforo 45° con bocca corta girevole.
 Altezza: 21 cm - Interasse: 12,5 cm.
Single-lever sink mixer 45° with short movable spout.
 Height: 21 cm - Interaxis: 12,5 cm.



OM629
 Monocomando lavello con canna girevole.
 Altezza: 17 cm - Interasse: 22,5 cm.
Single-lever sink mixer with swiveling spout.
 Height: 17 cm - Interaxis: 22,5 cm.

ACQUA DEPURATA - PURIFIED WATER



OMT679DW

Miscelatore lavello a tre vie di ingresso con bocca girevole e due vie d'uscita completamente indipendenti, con selezione acqua potabile tramite la leva.

Altezza: 35,7 cm - Interasse: 17,2 cm.

Three ways inlet single lever sink mixer, with movable spout and two fully independent outlets, with selection for drinking water directly from the lever.

Height: 35,7 cm - Interaxis: 17,2 cm.



TOUCH-ME



OMT618U

Miscelatore monocomando lavello, monoforo 90° con canna alta quadra a "U" dotata di tecnologia Touch-Me con leva laterale e bocca girevole. Dotato di cartuccia Ø35.

Altezza: 33 cm - Interasse: 21,5 cm.

Single-lever sink mixer 90°, high squared "U" spout equipped with Touch-Me system with side lever and movable spout. Equipped with Ø35 cartridge.

Height: 33 cm - Interaxis: 21,5 cm.



OMT618

Miscelatore monocomando lavello, monoforo 90° con canna alta a "U" dotata di tecnologia Touch-Me con leva laterale e bocca girevole. Dotato di cartuccia Ø 35.

Altezza: 34 cm - Interasse: 17,5 cm.

Single-lever sink mixer 90°, high "U" spout equipped with Touch-Me system with side lever and movable spout. Equipped with Ø35 cartridge.

Height: 34 cm - Interaxis: 17,5 cm.





SMART

La collezione SMART è una linea di rubinetteria giovane che completa con note di semplicità ed eleganza gli arredi di bagno e cucina. Le superfici piatte e parallele di leva e bocca esprimono un design moderno, mentre l'apertura sulla maniglia alleggerisce e personalizza tutta la serie. Nella sua semplicità SMART può soddisfare tutte le composizioni bagno grazie alle diverse soluzioni di miscelatori per lavabo sia da incasso che da appoggio, oltre ai miscelatori a più vie per vasca e doccia. Spicca per completezza anche la proposta SMART di modelli dedicati alla cucina, una vasta gamma di opzioni capaci di rispondere ad ogni esigenza di prezzo, funzionalità ed estetica. Alcuni miscelatori per cucina della linea SMART sono inoltre disponibili nella versione con tecnologia integrata Touch-Me.

Design by Cristian Mapelli

The SMART collection is a line of young faucets that complete the bathroom and kitchen furnishings with notes of simplicity and elegance.

The flat and parallel surfaces of lever and mouth express a modern design, while the opening on the handle lightens and characterizes the whole series. In its simplicity, SMART can satisfy all bathroom compositions thanks to the different solutions of both built-in and countertop basin mixers, as well as multi-way mixers for bath and shower. Also the SMART proposal dedicated to kitchen stands out for its completeness, a wide range of options which is able to meet every need of price, functionality and aesthetics. Some kitchen mixers of the SMART line are also available in the version with integrated Touch-Me technology.

Design by Cristian Mapelli

FINISHINGS

CP cromo spazzolato
brushed chrome

NP nichel spazzolato
brushed nickel

NPO nichel spazzolato opaco
matt brushed nickel

63 vecchio ottone
old brass

OIL oil bronze
oil bronze

64 vecchio rame
old copper

14 bianco opaco
matt white

15 nero opaco
matt black

FIN 2

DO oro lucido
shiny gold

DP oro spazzolato
brushed gold

FZ cromo nero spazzolato lucido
shiny brushed black chrome

CF cromo nero lucido
shiny black chrome

RL rame lucido
shiny copper

GO grafite
graphite

FIN 4

PG oro rosa lucido
shiny pink gold

PP oro rosa spazzolato
brushed pink gold

RPO rame anodizzato
anodised copper

FIN 5

Finiture consigliate per questa collezione.

Per l'elenco completo fare riferimento alla tabella delle finiture (pag.04)

Suggested finishes for this collection.

For a complete list of available colors, please refer to the finishing table (page 04)



CONTEMPORANEO
CONTEMPORARY

OMEGA

SMART

OMEGA

ECO

SMART

ECO



CARATTERISTICHE TECNICHE:

La serie è dotata di cartuccia a dischi ceramici Ø 35 mm, prodotta da S.T.S.R. Studio Tecnico Sviluppo e Ricerche www.stsr.it

TECHNICAL CHARACTERISTICS:

The series is equipped with ceramic cartridge Ø 35 mm, produced by S.T.S.R. - Research Development Technical Office www.stsr.it

LAVABI - WASHBASIN MIXERS



Monocomando lavabo.
Altezza: 15 cm - Interasse: 10,7 cm.
*Single-lever basin mixer.
Height: 15 cm - Interaxis: 10,7 cm.*

SR605

con scarico.
with pop-up waste.

SR605A

con scarico in plastica.
with plastic pop-up waste.

SR606

senza scarico
without waste.

SR606N

senza scarico e senza foro nel corpo.
without waste and without body hole.



Monocomando lavabo XL.
Altezza: 30,5 cm - Interasse: 18,2 cm.
*XL basin mixer.
Height: 30,5 cm - Interaxis: 18,2 cm.*

SR607

con scarico click-clack.
with click-clack waste.

SR607B

senza scarico
without waste.



SR655

Miscelatore monocomando lavabo a due fori.
Altezza: 23,2 cm - Interasse: 17,2 cm.
*two holes built-in basin mixer.
Height: 23,2 cm - Interaxis: 17,2 cm.*



SR634

Miscelatore monocomando a incasso per lavabo, bocca 18 cm, con piastra rettangolare verticale.
Single-lever built-in basin mixer, spout 18 cm, with vertical rectangular wall flange.



SR632

Miscelatore monocomando a incasso per lavabo, bocca 18 cm, con piastra rettangolare.
Single-lever built-in basin mixer, spout 18 cm, with rectangular wall flange.

LAVABO BOX INCASSO - BUILT-IN BOX WASHBASIN MIXER



SR632KB

Miscelatore monocomando a incasso per lavabo, con piastra in ottone cromato, bocca lunghezza 18 cm, da abbinare al box incasso.

Single-lever built-in basin mixer, with wall flange in chrome plated brass, spout length 18 cm, to match with the built-in box.



DAN BOX632

Box da incasso per miscelatore monocomando a incasso per lavabo.
Built-in box for single-lever built-in basin mixer.

OMEGA

SMART

OMEGA

ECO

SMART

ECO

BIDET - BIDET MIXERS



Miscelatore bidet.
Altezza: 12,5 cm - Interasse: 10,5 cm.
Bidet mixer.
Height: 12,5 cm - Interaxis: 10,5 cm.

SR604

con scarico.
with pop-up waste.

SR604A

con scarico in plastica.
with plastic pop-up waste.

SR604B

senza scarico
without waste.



Miscelatore incasso per shut-off su piastra in ottone cromato.
Built-in shower mixer all in c.p. brass.

SR645

comprendivo di doccetta shut-off art. 1000DC, supporto doccia-presa acqua, tutto in ottone cromato e flessibile doccia cm 120.
including shut-off art. 1000DC, shower holder-water punch on flange, all in c.p. brass and shower flexible cm 120.

SR645H

senza kit shut-off.
without shut-off set.



SR605SH4DC

Miscelatore monocomando lavabo con doccia shut-off e scarico click-clack con troppo pieno.
Single-lever basin mixer with shut-off handshower and click-clack pop-up waste with overflow.



SR642

Miscelatore incasso per shut-off con doccetta shut-off, supporto doccia, presa acqua.
Built-in shut-off mixer set shut-off, shower holder, water punch.

INCASSI DOCCIA - BUILT-IN MIXERS



SR602

Monocomando doccia incasso.
Built-in shower mixer.

IN602C35

Parte interna miscelatore monocomando incasso doccia.
Single-lever shower mixer (built-in components).

SR602EKIT

Parte esterna miscelatore monocomando incasso doccia.
Single-lever shower mixer (external components).



SR612

Monocomando vasca incasso con deviatore.
Built-in bath/shower mixer with diverter..

IN612C35

Parte interna miscelatore monocomando incasso vasca/doccia con deviatore.
Single-lever bath/shower mixer with diverter (built-in components).

SR612EKIT

Parte esterna miscelatore monocomando incasso vasca/doccia con deviatore.
Single-lever bath/shower mixer with diverter (external components).



SR612D2

Miscelatore monocomando per doccia con deviatore a 2 vie su piastra unica.
Single-lever shower mixer, with 2 ways diverter on single flange.



SR612D3

Miscelatore monocomando per doccia con deviatore a 3 vie e 3 posizioni (una entrata e tre uscite), su unica piastra.
Single lever built-in shower mixer with 3 ways diverter and 3 positions (1 inlet and 3 outlets), on single flange.



SR612D4

Miscelatore monocomando per doccia con deviatore a quattro vie (4 uscite ed 1 entrata) su piastra unica.
Single lever built-in shower mixer with four ways diverter (4 outlets and 1 inlet) on single flange.



SR612D5

Miscelatore monocomando per doccia, con deviatore a 5 vie (5 uscite ed una entrata) su piastra singola.
Single-lever shower mixer with 5 ways diverter (5 outlets and 1 inlet) on single flange.



SR612D7

Miscelatore monocomando per doccia con deviatore a tre vie e sette posizioni su unica piastra.
Single lever built-in shower mixer with three ways diverter with seven positions on single flange.

BOX INCASSO - BUILT-IN BOX

SR602KB

Set miscelatore doccia da abbinare al box incasso.
Shower mixer set to match with the built-in box.



+



DAN BOX

Box da incasso per miscelatore doccia con deviatore.
Built-in box for shower mixer with diverter.

OMEGA

SMART

SR612KB

Set miscelatore doccia con deviatore da abbinare al box incasso.
Shower mixer set with diverter to match with the built-in box.



+



DAN BOX

Box da incasso per miscelatore doccia con deviatore.
Built-in box for shower mixer with diverter.

OMEGA

ECO

SMART

ECO

SR612D2KB

Set miscelatore doccia due vie da abbinare al box incasso.
Two ways shower mixer set to match with the built-in box.



+



DAN BOXD2

Box da incasso per miscelatore doccia due vie.
Built-in box for two ways shower mixer.

SR612D3KB

Set miscelatore doccia tre vie da abbinare al box incasso.
Three ways shower mixer set to match with the built-in box.



+



DAN BOXD3

Box da incasso per miscelatore doccia tre vie.
Built-in box for three ways shower mixer.

SR612D7KB

Set miscelatore doccia tre vie e sette posizioni da abbinare al box incasso.
Three ways and seven positions shower mixer set to match with the built-in box.



+



DAN BOXD3

Box da incasso per miscelatore doccia tre vie.
Built-in box for three ways shower mixer.



Miscelatore vasca esterno.
Exposed bath mixer.

SR610

con kit doccia, flessibile 150 cm.
with shower kit, flexible 150 cm.

SR600H

senza kit doccia.
without shower kit.



SR691

Miscelatore monocomando bordo vasca con doccetta in ABS cromato a 4 funzioni.
Single lever deck bath/shower mixer with c.p. ABS 4 functions handshower.



SR698

Miscelatore monocomando bordo vasca con deviatore integrato nel miscelatore, bocca a cascata e doccetta in ABS cromato a 4 funzioni.
Single lever deck bath/shower mixer with diverter integrated in the mixer, waterfall spout and c.p. ABS 4 functions handshower.



A335 434

Saliscendi cromato con asta tonda in ABS cromato e doccetta anticalcare a 4 funzioni con getto idromassaggio, getti in silicone.
Altezza: 60 cm.
C.p. ABS sliding rail set with round rod and anti-limestone with silicon jets, hydromassage 4 functions handshower
Height: 60 cm.



Miscelatore monocomando per vasca.
Single lever bath mixer.

SR606D

con deviatore integrato e kit doccia..
with diverter and shower kit.

SR606DH

senza kit doccia.
without shower kit.



Monocomando doccia esterno.
Exposed shower mixer.

SR631A

con kit doccia, flessibile 150 cm.
with shower kit, flexible 150 cm.

SR631

senza kit doccia.
without shower kit.



Miscelatore vasca/doccia
Bath/shower mixe.

SR600DH con attacco alto da 1/2" ed attacco inferiore da 1/2"
with upper 1/2" connection and lower connection 1/2".

SR600DH34 con attacco alto da 3/4" ed attacco inferiore da 1/2"
with upper 3/4" connection and lower connection 1/2".



SR631Z
Miscelatore doccia esterno con attacco superiore.
Single lever deck shower mixer with upper connection.

CONTEMPORANEO
CONTEMPORARY

OMEGA

SMART

OMEGA

ECO

SMART

ECO

COLONNE VASCA/DOCCIA - BATH/SOWER COLUMN



SR636DA7820

Miscelatore vasca/doccia serie Smart con attacco alto da 3-4" ed attacco inferiore da 1/2", colonna doccia telescopica, doccetta anticalcare a 4 funzioni, con flessibile A505X 150 cm e soffione ultrapiatto Ø 20 cm, in acciaio inox lucidato a specchio con getti in silicone anticalcare.
Bath/shower mixer Smart series with upper 3/4" connection and lower connection 1/2", with telescopic shower column, c.p. handshower 4 functions antilimestone, with A505X 150 cm flexible hose and ultra slim stainless steel mirror polished shower head Ø 20 cm, with antilimestone silicon jets.



SR636DAEC20

Miscelatore vasca/doccia serie Smart con attacco alto da 3-4" ed attacco inferiore da 1/2", colonna doccia telescopica, doccetta anticalcare a 4 funzioni, con flessibile A505X 150 cm e soffione a pioggia, in ABS cromato, Ø 20 cm, con getti in silicone anticalcare.
Bath/shower mixer Smart series with upper 3/4" connection and lower connection 1/2", with telescopic shower column, c.p. handshower 4 functions antilimestone, with A505X 150 cm flexible hose and c.p. ABS shower head, rain jet, Ø 20 cm, with anti-limestone silicon jets.



SMART

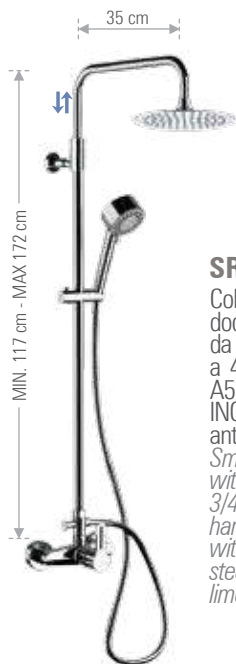

SR636A7820

Colonna doccia serie Smart con miscelatore doccia con deviatore integrato e attacco alto da 3/4", colonna doccia telescopica, doccetta a 4 funzioni con getti anticalcare, con flessibile A505X 150 cm e soffione a pioggia, in acciaio INOX cromato, Ø 20 cm, con getti in silicone anticalcare.

Smart series shower column with shower mixer with integrated diverter and upper connection 3/4", with telescopic shower column, c.p. handshower 4 functions with antilimestone jets, with A505X 150 cm flexible hose and c.p. stainless steel shower head, rain jet, Ø 20 cm, with anti-limestone silicon jets.

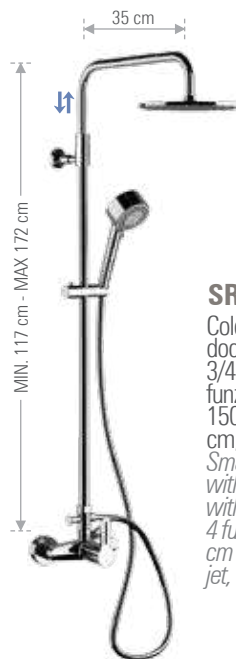

SR636A8420

Colonna doccia serie Smart con miscelatore doccia con deviatore integrato e attacco alto da 3/4", colonna doccia telescopica, doccetta a 4 funzioni con getti anticalcare, con flessibile A505X 150 cm e soffione a pioggia, in ABS cromato, Ø 20 cm, con getti in silicone anticalcare.

Smart series shower column with shower mixer with integrated diverter and upper connection 3/4", with telescopic shower column, c.p. handshower 4 functions with antilimestone jets, with A505X 150 cm flexible hose and c.p. ABS shower head, rain jet, Ø 20 cm, with anti-limestone silicon jets.

WELLNESS



SR614Z

Set doccia composto da soffione minimale in ABS lusso Ø20 cm con braccio 30 cm, miscelatore incasso vasca/doccia con deviatore, saliscendi minimale in ABS cromato con doccetta in ABS cromato anticalcare a 4 funzioni, attacco presa acqua da 1/2 tipo rotondo pesante.

Shower set composed of minimal deluxe ABS shower head Ø20 cm with arm cm 30, built-in bath/shower mixer with diverter, c.p. ABS minimal sliding rail set with anti-limestone 4 functions handshower, brass wall connector, round heavy type.



SR615Z

Set doccia composto da soffione minimale in ABS lusso Ø20 cm con braccio 30 cm, miscelatore incasso vasca/doccia con deviatore, con doccetta anticalcare a 4 funzioni con supporto presa acqua.

Shower set composed of minimal deluxe ABS shower head Ø20 cm with arm cm 30, built-in bath/shower mixer with diverter, anti-limestone c.p. ABS 4 functions handshower with waterpunch-shower holder.



SR614Z0

Set doccia composto da soffione minimale in ottone cromato Ø20 cm con braccio 30 cm, miscelatore incasso vasca/doccia con deviatore, saliscendi minimale con doccetta a 1 funzione, attacco presa acqua da 1/2 tipo rotondo pesante. Tutto in in ottone cromato.

Shower set composed of minimal deluxe c.p. brass shower head Ø20 cm with arm 30 cm, built-in bath/shower mixer with diverter, Minimal sliding rail set with handshower, wall connector round heavy type. All in c.p. brass.



SR615Z0

Set doccia composto da soffione minimale in ottone cromato Ø20 cm con braccio 30 cm, miscelatore incasso vasca/doccia con deviatore, doccetta ad 1 funzione e supporto presa acqua. Tutto in ottone cromato.

Shower set minimal deluxe c.p. brass shower head Ø20 cm with arm 30 cm, built-in bath/shower mixer with diverter, 1 function handshower with waterpunch/shower holder. All in c.p. brass.



SR618

Miscelatore lavello monoforo 90° con canna alta girevole.
Altezza: 33,5 cm - Interasse: 17,5 cm.
Single-lever sink mixer 90° with high movable spout.
Height: 33,5 cm - Interaxis: 17,5 cm.



OMEGA

SMART

OMEGA

ECO

SMART

ECO



SR618C

Miscelatore lavello monoforo 90° con canna girevole, modello corto.
Altezza: 30 cm - Interasse: 12 cm.
Single-lever sink mixer 90° with movable spout, short type.
Height: 30 cm - Interaxis: 12 cm.



SR633

Miscelatore monocomando lavello a muro, con leva frontale e bocca girevole.
Altezza: 25 cm - Interasse: 19 cm.
Single-lever wall mounted sink mixer with frontal lever and movable spout.
Height: 25 cm - Interaxis: 19 cm.



SR633B

Miscelatore lavello a muro, con leva frontale e canna alta girevole.
Altezza: 28 cm - Interasse: 17 cm.
Single-lever wall mounted sink mixer with frontal lever and high movable spout.
Height: 28 cm - Interaxis: 17 cm.



SR614B

Miscelatore monocomando per lavello, con bocca alta girevole.
Altezza: 30 cm - Interasse: 17 cm.
Single-lever one-hole sink mixer, with high movable spout.
Height: 30 cm - Interaxis: 17 cm.



SR614BC

Miscelatore monocomando per lavello, con canna corta girevole.
Altezza: 26 cm - Interasse: 12,5 cm.
Single-lever one-hole sink mixer, with short movable spout.
Height: 26 cm - Interaxis: 12,5 cm.



SR689

Miscelatore monocomando lavello a molla con doccetta estraibile ed orientabile a due funzioni e cartuccia Ø 35.

Altezza: 48 cm - Interasse: 21,5 cm.

Spring single-lever sink mixer with pull-out and swivelling 2-functions hand shower and Ø 35 mm cartridge.

Height: 48 cm - Interaxis: 21,5 cm.



SR233

Miscelatore lavello monocomando con flessibile nero rivestito con molla "fine design" girevole 360°, con doccetta estraibile ed orientabile a due funzioni e cartuccia Ø 35.

Altezza: 40,7 cm - Interasse: 21 cm.

Single-lever mixer with black flexible hose coated with "fine design" spring, 360° movable, with pull-out and swivelling 2-functions hand shower and Ø 35 mm cartridge.

Height: 40,7 cm - Interaxis: 21 cm.



SR614TC

Miscelatore lavello monoforo 45° con bocca girevole, modello corto.

Altezza: 21 cm - Interasse: 12,5 cm.

Single-lever sink mixer 45° with movable spout short type.

Height: 21 cm - Interaxis: 12,5 cm.



SR614T

Miscelatore lavello monoforo 45° con bocca alta girevole.

Altezza: 27 cm - Interasse: 18 cm.

Single-lever sink mixer 45° with high movable spout.

Height: 27 cm - Interaxis: 18 cm.



SR609T

Miscelatore lavello a muro con canna girevole.

Lunghezza canna: 20 cm.

Wall-mounted single-lever sink mixer with movable spout.

Lenght spout: 20 cm.



SR609S

Miscelatore lavello a muro con bocca ad "S" girevole.

Lunghezza canna: 20 cm.

Wall-mounted single-lever sink mixer with "S" movable spout.

Lenght spout: 20 cm.



SR614R

Miscelatore monocomando per lavello, con bocca alta girevole, tipo lusso.

Altezza: 29 cm - Interasse: 19,5 cm.

Single-lever one-hole sink mixer, with high movable spout, luxury type.

Height: 29 cm - Interaxis: 19,5 cm.



SR617

Miscelatore monocomando lavello con bocca alta quadrata ad "U" girevole.

Altezza: 27 cm - Interasse: 22 cm.

Single-lever sink mixer with "U" squared high movable spout.

Height: 27 cm - Interaxis: 22 cm.



SR629

Monocomando lavello con canna fusa girevole.

Altezza canna: 16 cm

Interasse: 22,5 cm.

Single-lever sink mixer with swiveling casted spout.

Spout height: 16 cm

Interaxis: 22,5 cm.

ACQUA DEPURATA - PURIFIED WATER



SR679DW

Miscelatore lavello a tre vie di ingresso con bocca girevole e due vie d'uscita completamente indipendenti, con selezione acqua potabile tramite la leva.

Altezza: 35,7 cm - Interasse: 17,2 cm.
Three ways inlet single lever sink mixer, with movable spout and two fully independent outlets, with selection for drinking water directly from the lever.

Height: 35,7 cm - Interaxis: 17,2 cm.



OMEGA

SMART

OMEGA

ECO

SMART

ECO

TOUCH-ME



SRT618C

Miscelatore monocomando lavello, monoforo 90° con canna corta a "U" dotata di tecnologia Touch-Me con leva laterale e bocca girevole. Dotato di cartuccia Ø 35.

Altezza: 30,5 cm - Interasse: 17,5 cm.
Single-lever sink mixer 90°, short model "U" spout equipped with Touch-Me system with side lever and movable spout. Equipped with Ø 35 cartridge.

Height: 30,5 cm - Interaxis: 17,5 cm.



SRT618

Miscelatore monocomando lavello, monoforo 90° con canna alta a "U" dotata di tecnologia Touch-Me con leva laterale e bocca girevole. Dotato di cartuccia Ø35.

Altezza: 34 cm - Interasse: 17,5 cm.
Single-lever sink mixer 90°, high "U" spout equipped with Touch-Me system with side lever and movable spout. Equipped with Ø35 cartridge.

Height: 34 cm - Interaxis: 17,5 cm.



SRT618U

Miscelatore monocomando lavello, monoforo 90° con canna alta quadra a "U" dotata di tecnologia Touch-Me con leva laterale e bocca girevole. Dotato di cartuccia Ø35.

Altezza: 33 cm - Interasse: 21,5 cm.
Single-lever sink mixer 90°, high squared "U" spout equipped with Touch-Me system with side lever and movable spout. Equipped with Ø35 cartridge.

Height: 33 cm - Interaxis: 21,5 cm.



DANIEL
RUBINETTERIE

MILANO

MADE IN ITALY
www.daniel.it



SMART BOX

SMART BOX

COMPOSIZIONE DEL BOX - BOX COMPOSITION:



SRKIT1

Set composto da: miscelatore lavabo con scarico SR605, miscelatore vasca SR600H e saliscendi cromato con asta tonda, con doccetta anticalcare ed idromassaggio con getti in silicone a 4 funzioni A310434I e flessibile in acciaio inox.

Set composed of: basin mixer with waste SR605, exposed bath/shower mixer SR600 Hand C.P. sliding rail set with round rod and anti-limestone hydromassage 4 functions handshower with silicon jets A310434I and flexible hose in stainless steel.

OMEGA

SMART

OMEGA

ECO

SMART

ECO

COMPOSIZIONE DEL BOX - BOX COMPOSITION:



SRKIT4P1

Set composto da: miscelatore lavabo con scarico SR605, bidet con scarico SR604, miscelatore vasca SR600H e saliscendi cromato con asta tonda, con doccetta anticalcare ed idromassaggio con getti in silicone a 4 funzioni A310434I e flessibile in acciaio inox.

Set composed of: basin mixer with waste SR605, bidet with waste SR604, exposed bath/shower mixer SR600H and C.P. sliding rail set with round rod and anti-limestone hydromassage 4 functions handshower with silicon jets A310434I and flexible hose in stainless steel.

PROGRAMMA PROGRAM



Il programma ECO raccoglie una serie di tecnologie e accorgimenti dedicati al risparmio idrico ed energetico. Grazie alla combinazione di diverse tecnologie è possibile generare un'effettiva riduzione dei consumi con un impatto positivo sia economico che ambientale.

ENERGY SAVING: LIMITAZIONE DELLE APERTURE ACCIDENTALI DI ACQUA CALDA.

La specifica cartuccia, quando la leva è in posizione allineata alla bocca del rubinetto, consente l'apertura in sola acqua fredda. Questo evita la richiesta indesiderata di acqua calda, permettendo perciò un risparmio energetico. Per richiedere l'acqua calda basterà ruotare la leva verso sinistra.

ANTISCALDING: LIMITAZIONE DELLA TEMPERATURA MASSIMA.

Una speciale ghiera posizionata sulla cartuccia, previa regolazione, limita la temperatura massima erogabile, impedendo la completa rotazione della maniglia verso l'acqua calda. L'impostazione "di fabbrica" della ghiera è in posizione neutra. (opzione combinabile alla tecnologia precedente).

WATER SAVING DYNAMIC: LIMITAZIONE DINAMICA DELLA PORTATA

La limitazione dinamica della portata dell'acqua avviene tramite una leggera limitazione all'apertura della leva del miscelatore intorno al 50% dell'erogazione massima. Questo risulta essere un invito all'utente a non aprire completamente il flusso dell'acqua quando non strettamente necessario riducendo i consumi. L'erogazione fino al 100 % del flusso rimane comunque sempre possibile una volta superata questa leggera resistenza. (opzione combinabile alle tecnologie precedenti).

WATER SAVING: aeratore con limitazione di portata, erogazione ad 8 litri al minuto (6, 4, 3 litri al minuto in alternativa).

The ECO program includes a series of technologies and measures designed to save water and energy. Thanks to the combination of different technologies it is possible to generate an effective reduction of consumption with a positive economic and environmental impact.

ENERGY SAVING: LIMITATION OF THE ACCIDENTAL OPENINGS OF HOT WATER.

The specific cartridge, when the lever is aligned with the spout, allows the opening in cold water only. This avoids the unwanted demand for hot water, thus allowing energy savings. To request hot water, simply turn the lever to the left.

ANTISCALDING: LIMITATION OF THE MAXIMUM TEMPERATURE.

A special ring-nut positioned on the cartridge limits the maximum temperature that can be delivered, preventing the complete rotation of the handle towards the hot water. The "factory" setting of the ring is in the neutral position. (option combinable with previous technology).

WATER SAVING DYNAMIC: DYNAMIC LIMITATION OF WATER FLOW

The dynamic limitation of the water flow occurs with a slight limitation to the mixer lever opening around 50% of the maximum delivery. This turns out to be an invitation to the user not to completely open the water flow when not strictly necessary, reducing consumption. The flow delivery up to 100% is always possible once this slight resistance is overcome. (option combinable with previous technologies).

WATER SAVING: aerator with flow limitation, delivery to 8 liters per minute (6, 4, 3 liters per minute also available).

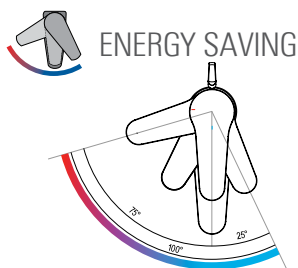

COD. A803
STANDARD
8 L/min



OPTIONS:

3 L/MIN
4 L/MIN
6 L/MIN



STOP ANTISCALDING

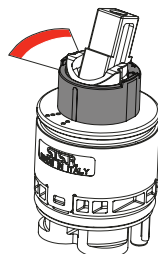

WATER SAVING DYNAMIC

FULL FLOW 2
WATER SAVING 1
CLOSE 0

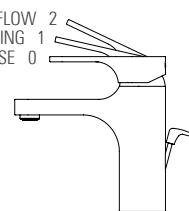

Design e tecnologia ambientale - Design and environmental technology



CARTUCCIA MADE IN ITALY
TECNOLOGICA REALIZZATA
CON PLASTICA ALIMENTARE
ECO FRIENDLY
MADE IN ITALY ECO FRIENDLY
TECHNOLOGIC CARTRIDGE

AERATORE A RISPARMIO IDRICO
WATER SAVING AERATOR

FLESSIBILI MADE IN ITALY,
IN GOMMA ALIMENTARE EPDM,
RACCORDATI CON
MACCHINE AUTOMATICHE
MADE IN ITALY FLEXIBLE HOSES,
WITH EPDM ALIMENTARY RUBBER,
MADE BY AUTOMATIC
ASSEMBLING MACHINES

Gli articoli doccia e vasca non sono stati proposti in quanto si presuppone che non vi sia la necessità di apertura in acqua fredda in quanto gli ambienti vasca e doccia sono generalmente utilizzati per loro natura con acqua miscelata/calda. Per completare la gamma Eco con gli articoli vasca/doccia si consiglia di utilizzare la serie nella versione cartuccia standard. Le versioni eco vasca e doccia sono comunque disponibili a richiesta.

The shower and bathtub items are not offered because it is assumed that there is no need to open in cold water as the bathtub and shower environments are generally used with mixed/hot water for their nature. To complete the Eco range with bath/shower items, we suggest to use the series in standard cartridge version. The bath and shower eco versions are anyway available on demand.



CARTUCCIA MADE IN ITALY
TECNOLOGICA REALIZZATA
CON PLASTICA ALIMENTARE
ECO FRIENDLY
MADE IN ITALY ECO FRIENDLY
TECHNOLOGIC CARTRIDGE

AERATORE A RISPARMIO IDRICO
WATER SAVING AERATOR

FLESSIBILI MADE IN ITALY,
IN GOMMA ALIMENTARE EPDM,
RACCORDATI CON MACCHINE
AUTOMATICHE
MADE IN ITALY FLEXIBLE HOSES,
WITH EPDM ALIMENTARY RUBBER,
MADE BY AUTOMATIC ASSEMBLING
MACHINES

FINISHINGS

FIN 2				
CP cromo spazzolato brushed chrome	NP nichel spazzolato brushed nickel	NPO nichel spazzolato opaco matt brushed nickel	63 vecchio ottone old brass	OIL oil bronze oil bronze
64 vecchio rame old copper	14 bianco opaco matt white	15 nero opaco matt black		
FIN 4				
DO oro lucido shiny gold	DP oro spazzolato brushed gold	FZ cromo nero spazzolato lucido shiny brushed black chrome	CF cromo nero lucido shiny black chrome	RL rame lucido shiny copper
GO grafite graphite				
FIN 5				
PG oro rosa lucido shiny pink gold	PP oro rosa spazzolato brushed pink gold	RPO rame anodizzato anodised copper		

Finiture consigliate per questa collezione.
Per l'elenco completo fare riferimento alla tabella delle finiture (pag.04)

*Suggested finishes for this collection.
For a complete list of available colors, please refer to the finishing table (page 04)*



OMEGA

Le linee dolci e tondeggianti della collezione OMEGA sposano il programma ECO, inserendo nella fornitura standard la cartuccia ENERGY SAVING per limitare le richieste accidentali di acqua calda quando la leva è in posizione parallela alla bocca del miscelatore.

La serie OMEGA ECO è inoltre dotata di aeratore a risparmio idrico con limitazione di portata a 8 litri al minuto.

La collezione può essere integrata, su specifica richiesta, con le altre opzioni ECO a catalogo (ANTISCALDING e WATER SAVING DYNAMIC)

The soft and rounded lines of the OMEGA collection combine the ECO program, including in the standard furniture the ENERGY SAVING cartridge to limit accidental requests for hot water when the lever is parallel to the mixer's mouth.

OMEGA ECO series is also equipped with a water-saving aerator with a flow limitation of 8 liters per minute.

Series can be integrated, on demand, with the other ECO options on the catalog (ANTISCALDING and WATER SAVING DYNAMIC).

CARATTERISTICHE TECNICHE:

La serie è dotata di cartuccia a dischi ceramici Ø 35 mm, prodotta da S.T.S.R. Studio Tecnico Sviluppo e Ricerche www.stsr.it

TECHNICAL CHARACTERISTICS:

The series is equipped with ceramic cartridge Ø 35 mm, produced by S.T.S.R. - Research Development Technical Office www.stsr.it

LAVABI - WASHBASIN MIXERS



Monocomando lavabo.
Altezza: 15 cm - Interasse: 11 cm.
Single-lever basin mixer.
Height: 15 cm - Interaxis: 11 cm.



OME605LT8

con scarico.
with pop-up waste.

OME606LT8

senza scarico
without waste.



Monocomando lavabo alto.
Altezza: 17 cm - Interasse: 13 cm.
High single-lever basin mixer.
Height: 17 cm - Interaxis: 13 cm.



OME607LT8

con scarico.
with pop-up waste.

OME607BLT8

senza scarico
without waste.



Monocomando lavabo XL.
Altezza: 30,6 cm - Interasse: 18 cm.
XL basin mixer.
Height: 30,6 cm - Interaxis: 18 cm.



OME607XL8

con scarico click-clack.
with click-clack waste.

OME607XBL8

senza scarico
without waste.



OME688LT8

Miscelatore monocomando lavabo da pavimento con click-clack e troppo pieno.
Altezza bocca: 94 cm - Interasse: 16,8 cm.
Single-lever mixer floor mounting with click-clack and overflow.
Height spout: 94 cm - Interaxis: 16,8 cm.



OMEGA

SMART

OMEGA

ECO

SMART

ECO



OME632LT8

Miscelatore monocomando a incasso per lavabo, lunghezza bocca 18 cm, con piastra rettangolare.
Single-lever built-in basin mixer, length spout 18 cm, with rectangular wall flange.



OME634LT8

Miscelatore monocomando a incasso per lavabo, lunghezza bocca 18 cm, con piastra rettangolare verticale.
Single-lever built-in basin mixer, length spout 18 cm, with vertical rectangular wall flange.



BIDET - BIDET MIXERS



Miscelatore bidet.
Altezza: 13 cm - Interasse: 10,5 cm.
Bidet mixer.
Height: 13 cm - Interaxis: 10,5 cm.



OME604LT8

con scarico.
with pop-up waste.

OME604BL8

senza scarico
without waste.



OME645LT8

Miscelatore incasso per shut-off con doccetta shut-off, supporto doccia, presa acqua.
Built-in shut-off mixer set shut-off, shower holder, water punch.





OME609TLT8

Miscelatore lavello a muro con canna girevole.
Lunghezza canna: 20 cm.
Wall-mounted single-lever sink mixer with movable spout.
Length spout: 20 cm.



OME609SLT8

Miscelatore lavello a muro con bocca ad "S" girevole.
Lunghezza canna: 20 cm.
Wall-mounted single-lever sink mixer with "S" movable spout.
Length spout: 20 cm.



OME614RLT8

Miscelatore monocomando per lavello, con bocca alta girevole, tipo lusso.
Altezza: 29 cm - Interasse: 19,5 cm.
Single-lever one-hole sink mixer, with high movable spout, luxury type.
Height: 29 cm - Interaxis: 19,5 cm.



OME614TLT8

Miscelatore lavello monoforo 45° con bocca alta girevole.
Altezza: 27 cm - Interasse: 18 cm.
Single-lever sink mixer 45° with high movable spout.
Height: 27 cm - Interaxis: 18 cm.



OME614CLT8

Miscelatore lavello monoforo 45° con canna fusa corta.
Altezza: 21 cm - Interasse: 12 cm.
Single-lever sink mixer 45° with short movable casted spout.
Height: 21 cm - Interaxis: 12 cm.



OME614TCLT8

Miscelatore lavello monoforo 45° con bocca corta girevole.
Altezza: 21 cm - Interasse: 12,5 cm.
Single-lever sink mixer 45° with short movable spout.
Height: 21 cm - Interaxis: 12,5 cm.



OME618LT8

Miscelatore lavello monoforo 90° con canna alta girevole.
Altezza: 33,5 cm - Interasse: 17,5 cm.
Single-lever sink mixer 90° with high movable spout.
Height: 33,5 cm - Interaxis: 17,5 cm.



OME618CLT8

Miscelatore lavello monoforo 90° con canna alta girevole, modello corto.
Altezza: 29,2 cm - Interasse: 12,6 cm.
Single-lever sink mixer 90° with high movable spout, short type.
Height: 29,2 cm - Interaxis: 12,6 cm.

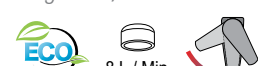



OME629LT8

Monocomando lavello con canna girevole.
Altezza canna: 16 cm - Interasse: 22,5 cm.
Single-lever sink mixer with swiveling
spout.
Spout height: 16 cm - Interaxis: 22,5 cm.



OME617LT8

Miscelatore lavello monoforo 45° con
canna alta "U" girevole.
Altezza: 27 cm - Interasse: 22 cm.
Single-lever sink mixer 45° with high
movable "U" spout.
Height: 27 cm - Interaxis: 2 cm.



OMEGA

SMART

OMEGA

ECO

SMART

ECO



OME624LT8

Miscelatore lavabo/vasca con canna
fusa lunga 30 cm, e con deviatore con
kit doccia.
Wall basin/bath single lever mixer
with long casted spout 30 cm, and
diverter with shower kit.



OME624HLT8

Miscelatore lavabo/vasca con canna fusa
lunga 30 cm, e con deviatore senza kit
doccia.
Wall basin/bath single lever mixer with
long casted spout 30 cm, and diverter
without shower kit.





SMART

SMART ECO combina la sua semplicità di design con il PROGRAMMA ECO, inserendo nella fornitura standard la cartuccia ENERGY SAVING per limitare le richieste accidentali di acqua calda quando la leva è in posizione parallela alla bocca del miscelatore.

La serie SMART ECO è inoltre dotata di aeratore a risparmio idrico con limitazione di portata a 8 litri al minuto.

La collezione può essere integrata, su specifica richiesta, con le altre opzioni ECO a catalogo (ANTISCALDING e WATER SAVING DYNAMIC)

SMART ECO combines its simplicity of design with the ECO PROGRAM, including in the standard furniture the ENERGY SAVING cartridge to limit accidental requests for hot water when the lever is parallel to the mixer's mouth.

SMART ECO collection is also equipped with a water-saving aerator with a flow limitation of 8 liters per minute.

The series can be integrated, on demand, with the other ECO options on the catalog (ANTISCALDING and WATER SAVING DYNAMIC).

CARATTERISTICHE TECNICHE:

La serie è dotata di cartuccia a dischi ceramici Ø 35 mm, prodotta da S.T.S.R. Studio Tecnico Sviluppo e Ricerche www.stsr.it

TECHNICAL CHARACTERISTICS:

The series is equipped with ceramic cartridge Ø 35 mm, produced by S.T.S.R. - Research Development Technical Office www.stsr.it

LAVABI E BIDET - WASHBASIN AND BIDET MIXERS



Monocomando lavabo.
Altezza: 15 cm - Interasse: 10,7 cm.
*Single-lever basin mixer.
Height: 15 cm - Interaxis: 10,7 cm.*



SRE605LT8

con scarico.
with pop-up waste.

SRE605ALT8

con scarico in plastica
with plastic waste.

SRE606LT8

senza scarico
without waste.



Monocomando lavabo XL.
Altezza: 30,5 cm - Interasse: 18,2 cm.
*XL basin mixer.
Height: 30,5 cm - Interaxis: 18,2 cm.*



SRE607LT8

con scarico click-clack.
with click-clack waste.

SRE607BLT8

senza scarico
without waste.



SRE632LT8

Miscelatore monocomando a incasso per lavabo, lunghezza bocca 18 cm, con piastra rettangolare.
Single-lever built-in basin mixer, length spout 18 cm, with rectangular wall flange.



SRE634LT8

Miscelatore monocomando a incasso per lavabo, lunghezza bocca 18 cm, con piastra rettangolare verticale.
Single-lever built-in basin mixer, length spout 18 cm, with vertical rectangular wall flange.

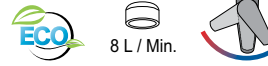

Miscelatore bidet.
Altezza: 12,5 cm - Interasse: 10,5 cm.
Bidet mixer.
Height: 12,5 cm - Interaxis: 10,5 cm.



SRE604LT8 con scarico.
with pop-up waste.

SRE604ALT8 con scarico in plastica
with plastic waste.

SRE604BLT8 senza scarico
without waste.



SRE645LT8

Miscelatore incasso per shut-off con doccetta shut-off, supporto doccia, presa acqua.
Built-in shut-off mixer set with shut-off, shower holder water punch.



CUCINA - KITCHEN



SRE618LT8

Miscelatore lavello monoforo 90° con canna alta girevole.
Altezza: 33,5 cm - Interasse: 17,5 cm.
Single-lever sink mixer 90° with high movable spout.
Height: 33,5 cm - Interaxis: 17,5 cm.



SRE618CLT8

Miscelatore lavello monoforo 90° con canna alta girevole, modello corto.
Altezza: 29,2 cm - Interasse: 12,6 cm.
Single-lever sink mixer 90° with high movable spout, short type.
Height: 29,2 cm - Interaxis: 12,6 cm.



SRE614TLT8

Miscelatore lavello monoforo 45° con bocca alta girevole.
Altezza: 22 cm - Interasse: 13 cm.
Single-lever sink mixer 45° with high movable spout.
Height: 22 cm - Interaxis: 13 cm.



SRE614RLT8

Miscelatore monocomando per lavello, con bocca alta girevole, tipo lusso.
Altezza: 29 cm - Interasse: 19,5 cm.
Single-lever one-hole sink mixer, with high movable spout, luxury type.
Height: 29 cm - Interaxis: 19,5 cm.



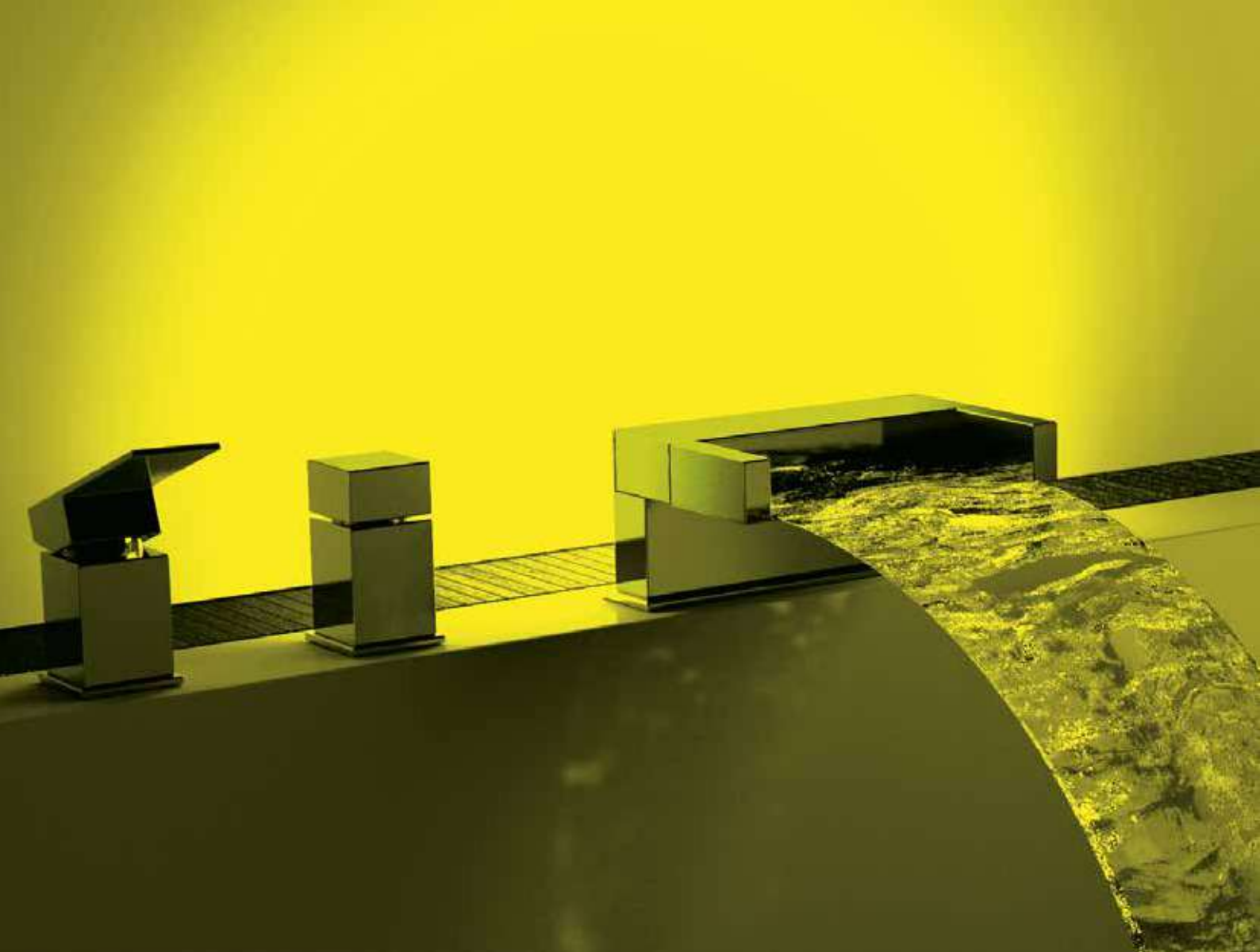

SKYLINE A M B I E N T

Le forme essenziali e squadrate della Collezione SKYLINE AMBIENT si arricchiscono della funzionalità di luce ambientale. La rubinetteria diventa fonte di una morbida luce led colorata che illumina dolcemente lo spazio circostante. Colore e intensità possono essere facilmente regolati tramite il pannello comandi nascosto sul lato posteriore del miscelatore, per comporre ambientazioni sempre uniche e personali.

The essential and square shapes of SKYLINE AMBIENT collection get enriched with the ambient light feature. The faucets become the source of a soft colored led light, softly illuminating the surrounding space. Colour and intensity can be easily adjusted using the control panel hidden on the back side of the mixer, in order to compose even more unique and personal environments.





FINISHINGS

FIN 2

-  **CP** cromo spazzolato
brushed chrome
-  **NP** nichel spazzolato
brushed nickel
-  **NPO** nichel spazzolato opaco
matt brushed nickel
-  **63** vecchio ottone
old brass
-  **OIL** oil bronze
oil bronze
-  **64** vecchio rame
old copper
-  **14** bianco opaco
matt white
-  **15** nero opaco
matt black

FIN 4

-  **DO** oro lucido
shiny gold
-  **DP** oro spazzolato
brushed gold
-  **RL** rame lucido
shiny copper
-  **FZ** cromo nero spazzolato lucido
shiny brushed black chrome
-  **CF** cromo nero lucido
shiny black chrome
-  **GO** grafite
graphite

FIN 5

-  **PG** oro rosa lucido
shiny pink gold
-  **PP** oro rosa spazzolato
brushed pink gold
-  **RPO** rame anodizzato
anodised copper

Finiture consigliate per questa collezione.
Per l'elenco completo fare riferimento alla tabella delle finiture (pag.04)

*Suggested finishes for this collection.
For a complete list of available colors, please refer to the finishing table (page 04)*

DECORI DISPONIBILI:
AVAILABLE DECORATIONS:

OPTICAL YP



DECO 1

-  **YP81** cromo lucido, decoro oro spazzolato.
shiny chrome, brushed gold decoration.

DECO 2

-  **YP84** nichel spazzolato, decoro cromo lucido.
brushed nickel, shiny chrome decoration.
-  **YP86** nichel spazzolato, decoro canna di fucile spazzolato.
brushed nickel, brushed gun barrel decoration.
-  **YP97** nichel spazzolato, decoro nichel lucido.
brushed nickel, shiny nickel decoration.

DECO 4

-  **YP85** nichel spazzolato, decoro oro spazzolato.
brushed nickel, brushed gold decoration.
-  **YP95** canna di fucile spazzolato, decoro cromo.
brushed gun barrel, chrome decoration.
-  **YP98** ottone spazzolato decoro ottone lucido.
brushed brass shiny brass decoration.

DECO 5

-  **YP82** oro lucido, decoro oro spazzolato.
shiny gold, brushed gold decoration.
-  **YP83** oro lucido, decoro nichel spazzolato.
shiny gold, brushed nickel decoration.
-  **YP88** oro antico, decoro canna di fucile spazzolato.
antique gold, brushed gun barrel decoration.
-  **YP96** oro spazzolato, decoro cromo.
brushed gold, chrome decoration.

DECO 6

-  **YP14** Bianco Opaco
Matt White
-  **YP15** Nero Opaco
Matt Black

DEKORA

SENSE

CARATTERISTICHE TECNICHE:

La serie è dotata di cartuccia a dischi ceramici Ø 25 mm, esclusi gli incassi che utilizzano la cartuccia a dischi ceramici Ø 35 mm, Cartucce ed elettronica prodotte da S.T.S.R. Studio Tecnico Sviluppo e Ricerche, www.stsr.it

TECHNICAL CHARACTERISTICS:

The series is equipped with ceramic cartridge Ø25 mm, except built-in items that use ceramic cartridge Ø35 mm. Cartridges and electronics are produced by S.T.S.R. Research Development Technical Office, www.stsr.it

LAVABI - WASHBASIN MIXERS



Monocomando lavabo dotato di dispositivo luminoso AMBIENT di retroilluminazione.
Altezza: 13,8 cm - Interasse: 15,5 cm
Single-lever basin mixer with led light AMBIENT device for back lighting.
Height: 13,8 cm - Interaxis: 15,5 cm.

SKA605

con scarico click-clack con troppo pieno.
with click-clack waste with overflow

SKA606

senza scarico.
without waste.



Monocomando lavabo alto dotato di dispositivo luminoso AMBIENT di retroilluminazione.
Altezza: 23 cm - Interasse: 18,4 cm
High basin mixer with led light AMBIENT device for back lighting.
Height: 23 cm - Interaxis: 18,4 cm.

SKA607

con scarico click-clack con troppo pieno.
with click-clack waste with overflow

SKA607B

senza scarico.
without waste.



Monocomando lavabo alto XL dotato di dispositivo luminoso AMBIENT di retroilluminazione.
Altezza: 27,5 cm - Interasse: 18,4 cm
High XL basin mixer with led light AMBIENT device for back lighting.
Height: 27,5 cm - Interaxis: 18,4 cm.

SKA607X

con scarico click-clack con troppo pieno.
with click-clack waste with overflow

SKA607XB

senza scarico.
without waste.

MISCELATORI VASCA - SHOWER MIXERS

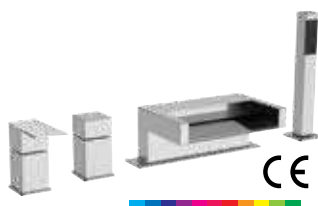

SKA697

Miscelatore monocomando bordo vasca dotato di dispositivo luminoso AMBIENT di retroilluminazione.
Single lever deck bath/shower mixer with led light AMBIENT device for back lighting.

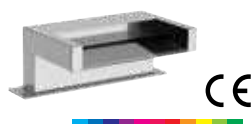

CA4705Q

Bocca bordo vasca a cascata dotato di dispositivo luminoso AMBIENT di retroilluminazione.
Waterfall built-in spout with led light AMBIENT device for back lighting.



SKYLINE
AMBIENT

CUBE
WATERFALL

OXY
LIGHT

CUCINA - KITCHEN



SKA608

Monocomando lavello bocca girevole dotato di dispositivo luminoso AMBIENT di retroilluminazione.
Altezza: 28,1 cm - Interasse: 20 cm
Single-lever Sink mixer swivelling spout with led light AMBIENT device for back lighting.
Height: 28,1 cm - Interaxis: 20 cm.



KCA201

Monocomando lavello bocca girevole dotato di dispositivo luminoso AMBIENT con illuminazione sotto la bocca di erogazione.
Altezza: 25 cm - Interasse: 20 cm.
Single-lever Sink mixer swivelling spout with led light AMBIENT device with light under the spout.
Height: 25 cm - Interaxis: 20 cm.



BOCCE A SOFFITTO
CEILING COLUMN

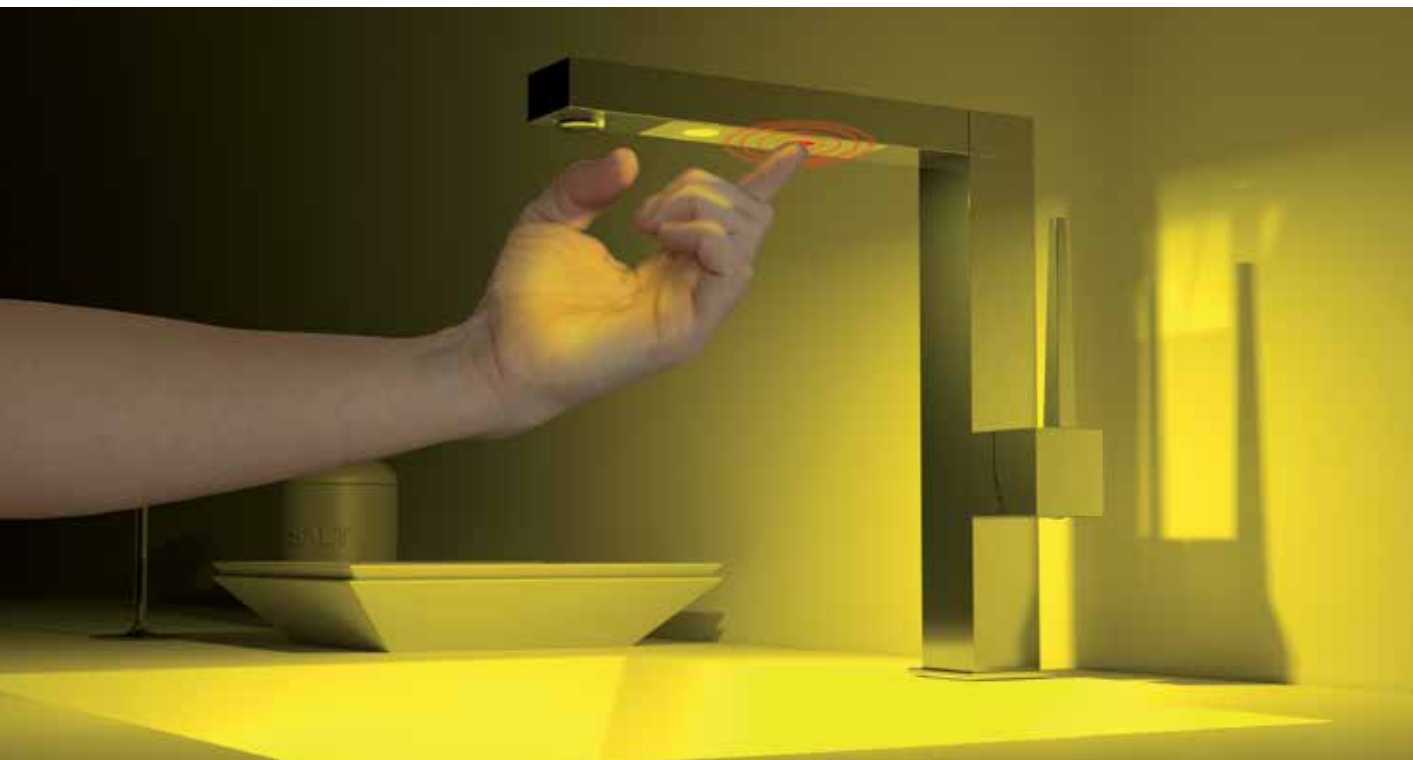



CUBE WATERFALL

Cube waterfall nasce dal desiderio di combinare forme spiccatamente moderne con l'incanto e l'armoniosità di una cascata naturale. Una collezione addolcita dai particolari scivoli cromati che permettono di osservare l'acqua corrente durante il suo fluire.
Design by Cristian Mapelli

*CUBE WATERFALL comes from the desire to combine distinctly modern shapes with the charm and the harmony of a natural waterfall. A collection softened by the particular chromed slides allowing to observe the water during its flow.
Design by Cristian Mapelli.*



FINISHINGS

FIN 2



FIN 4

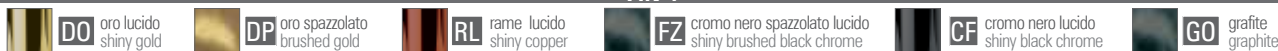

FIN 5



Finiture consigliate per questa collezione.

Per l'elenco completo fare riferimento alla tabella delle finiture (pag.04)

Suggested finishes for this collection.

For a complete list of available colors, please refer to the finishing table (page 04)

DECORI DISPONIBILI:
AVAILABLE DECORATIONS:

POP ART YL



DEKORA

DECO 1



DECO 2



DECO 4



DECO 5



DECO 6



SENSE

CUBE WATERFALL

CARATTERISTICHE TECNICHE:

La serie è dotata di cartuccia a dischi ceramici, Ø 35 mm, prodotta da S.T.S.R. Studio Tecnico Sviluppo e Ricerche www.stsr.it

TECHNICAL CHARACTERISTICS:

The series is equipped with ceramic cartridge, Ø 35 mm, produced by S.T.S.R. - Research Development Technical Office www.stsr.it

LAVABI E BIDET - WASHBASIN MIXERS AND BIDET



Monocomando lavabo con bocca a cascata.
Altezza: 16,5 cm - Interasse: 13,8 cm
Single-lever basin mixer with waterfall spout.
Height: 16,5 cm - Interaxis: 13,8 cm.

CW605 con scarico.
with pop-up waste.

CW606 senza scarico.
without waste.



Monocomando lavabo alto con bocca a cascata.
Altezza: 32,5 cm - Interasse: 15 cm
High basin mixer with waterfall spout.
Height: 32,5 cm - Interaxis: 15 cm.

CW607 con scarico click-clack.
with click-clack waste

CW607B senza scarico.
without waste.

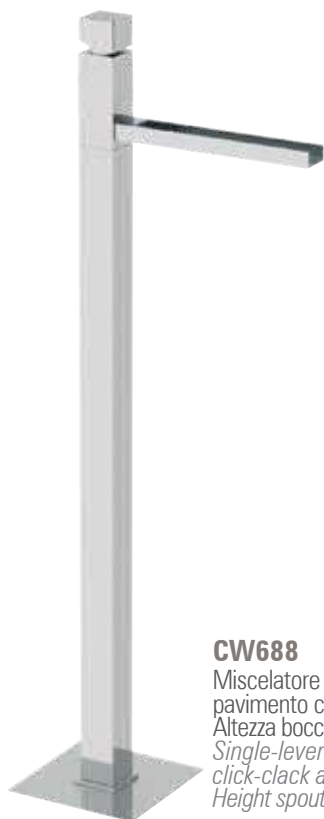

CW688
Miscelatore monocomando lavabo da pavimento con click-clack e troppo pieno.
Altezza bocca: 92 cm - Interasse: 15 cm
Single-lever mixer floor mounting with click-clack and overflow.
Height spout: 92 cm - Interaxis: 15 cm.





CW634

Miscelatore monocomando a incasso per lavabo, con piastra verticale rettangolare.
Lunghezza bocca: 19 cm.
*Single lever built-in basin mixer, with vertical rectangular wall flange.
Length spout: 19 cm.*



CW632

Miscelatore monocomando a incasso per lavabo, con piastra rettangolare.
Lunghezza bocca: 19 cm.
*Single-lever built-in basin mixer, with rectangular wall flange.
Length spout: 19 cm.*



Monocomando bidet.
Altezza: 16,5 cm - Interasse: 8,7 cm
*Single-lever bidet mixer.
Height: 16,5 cm - Interaxis: 8,7 cm.*

CU604 con scarico.
with pop-up waste.

CU604B senza scarico.
without waste.

SKYLINE
AMBIENT

CUBE
WATERFALL

OXY
LIGHT

BOCCHIE A SOFFITTO
CEILING COLUMN

INCASSI DOCCIA E BOCCHIE - BUILT-IN MIXERS AND SPOUTS



CU602

Miscelatore doccia incasso.
Built-in shower single-lever mixer.



CU612

Miscelatore vasca incasso con deviatore.
Built-in bath/shower mixer with diverter.



C4705Q

Bocca bordo vasca a cascata.
Waterfall built-in spout.



F4705Q

Bocca bordo vasca con effetto multigetto.
Spout with multijet effect for deck bath/shower mixer.



CA4704

Bocca incasso a cascata.
Built-in spout with waterfall jet.



CW4704

Bocca incasso a cascata, 18 cm.
Waterfall built-in spout, 18 cm.

MISCELATORI VASCA E DOCCIA - SHOWER AND BATH MIXERS



Miscelatore vasca esterno con bocca a cascata.
Exposed bath mixer with waterfall spout.

CW610

con kit doccia, flessibile 150 cm.
with shower kit, flexible 150 cm.

CW600

con kit doccia, flessibile 120 cm.
with shower kit, flexible 120 cm.

CW600H

senza kit doccia.
without shower kit.



CW678

Miscelatore vasca da pavimento con bocca a cascata, con deviatore e kit doccia.
Free standing bath mixer floor mounting with waterfall spout, with diverter and shower kit.
Altezza bocca: 78 cm - Interasse: 18,3 cm.
Height spout: 78 cm - Interaxis: 18,3 cm.

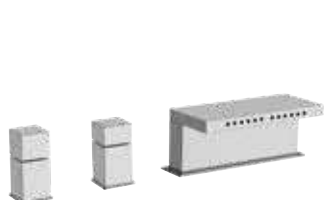

CU699

Miscelatore monocomando bordo vasca.
Single lever deck bath/shower mixer.

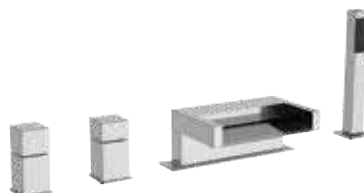

CU697

Miscelatore monocomando bordo vasca.
Single lever deck bath/shower mixer.



Monocomando doccia esterno.
Exposed shower mixer.

CU611A

con kit doccia.
with shower kit.

CU611

senza kit doccia.
without shower kit.



CU652

Miscelatore monocomando per vasca da incasso, su piastra in ottone cromato.
Single-lever bath mixer, with wall flange in chrome plated.

SKYLINE
AMBIENT

CUBE
WATERFALL

OXY
LIGHT

BOCCHETTE A
SOFFITTO
CEILING
COLUMN

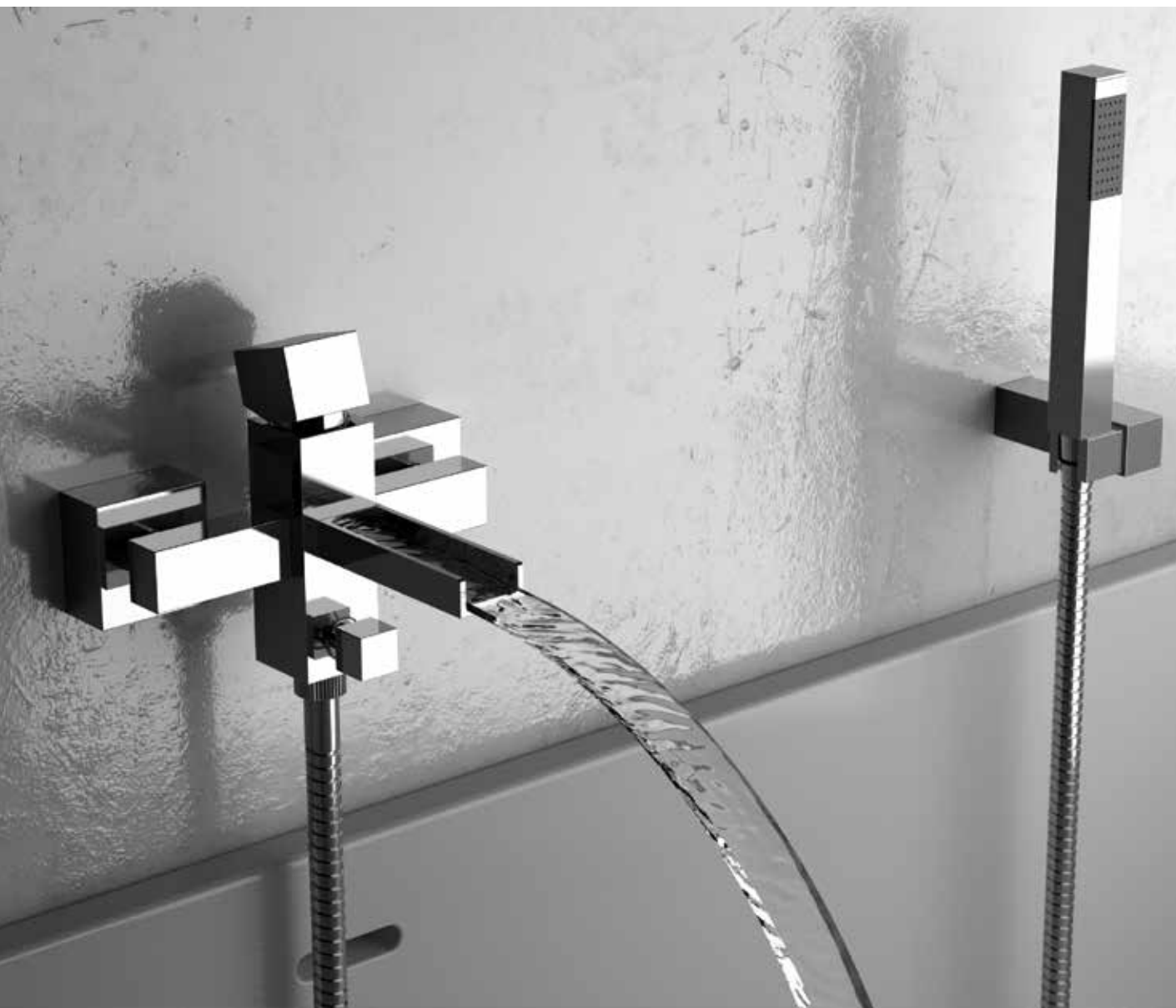



OXY LIGHT

Un soffice diffondersi di luce colorata accompagna il fluire dell'acqua, riempiendo la stanza da bagno di benessere e relax. La collezione OXY LIGHT ospita nel suo design moderno e minimale una turbina LED che, senza alcun collegamento elettrico, dà vita ad incantevoli giochi cromatici.

A soft spread of colorful light accompanying the water flow, filling the bath room with rest and wellness. OXY LIGHT collection features a LED turbine in its modern and minimal design, producing beautiful chromatic effects without any electrical connection.



FINISHINGS

FIN 2				
CP cromo spazzolato brushed chrome	NP nichel spazzolato brushed nickel	NPO nichel spazzolato opaco matt brushed nickel	63 vecchio ottone old brass	OIL oil bronze oil bronze
64 vecchio rame old copper	14 bianco opaco matt white	15 nero opaco matt black		
FIN 4				
DO oro lucido shiny gold	DP oro spazzolato brushed gold	RL rame lucido shiny copper	FZ cromo nero spazzolato lucido shiny brushed black chrome	CF cromo nero lucido shiny black chrome
FIN 5				
PG oro rosa lucido shiny pink gold	PP oro rosa spazzolato brushed pink gold	RPO rame anodizzato anodised copper		

Finiture consigliate per questa collezione.
Per l'elenco completo fare riferimento alla tabella delle finiture (pag.04)

Suggested finishes for this collection.
For a complete list of available colors, please refer to the finishing table (page 04)

DECORI DISPONIBILI:
AVAILABLE DECORATIONS: POP ART YL



DEKORA

DECO 1		
YL80 cromo lucido, decoro nichel spazzolato. shiny chrome, brushed nickel decoration.	YL81 cromo lucido, decoro oro spazzolato. shiny chrome, brushed gold decoration.	
DECO 2		
YL84 nichel spazzolato, decoro cromo lucido. brushed nickel, shiny chrome decoration.	YL86 nichel spazzolato, decoro canna di fucile spazzolato. brushed nickel, brushed gun barrel decoration.	YL97 nichel spazzolato, decoro nichel lucido. brushed nickel, shiny nickel decoration.
DECO 4		
YL85 nichel spazzolato, decoro oro spazzolato. brushed nickel, brushed gold decoration.	YL95 canna di fucile spazzolato, decoro cromo. brushed gun barrel, chrome decoration.	YL98 ottone spazzolato decoro ottone lucido. brushed brass shiny brass decoration.
DECO 5		
YL82 oro lucido, decoro oro spazzolato. shiny gold, brushed gold decoration.	YL83 oro lucido, decoro nichel spazzolato. shiny gold, brushed nickel decoration.	YL88 oro antico, decoro canna di fucile spazzolato. antique gold, brushed gun barrel decoration.
YL96 oro spazzolato, decoro cromo. brushed gold, chrome decoration.		

SENSE

DECO 6	
YL14 Bianco Opaco Matt White	YL15 Nero Opaco Matt Black

OXY LIGHT

CARATTERISTICHE TECNICHE:

La serie è dotata di cartuccia a dischi ceramici, Ø 35 mm, prodotta da S.T.S.R. Studio Tecnico Sviluppo e Ricerche www.stsr.it

TECHNICAL CHARACTERISTICS:

The series is equipped with ceramic cartridge, Ø 35 mm, produced by S.T.S.R. - Research Development Technical Office www.stsr.it

La tecnologia COLOUR LED LIGHT è disponibile in quattro varianti denominate A, B, C, D, di seguito dettagliate. Per evidenziare la Vostra scelta, aggiungere la lettera corrispondente a fine codice articolo.

The COLOUR LED LIGHT technology is available in four variants named A, B, C, D, that we detail here following. To highlight your selection please add the chosen letter at the end of the article number.

A  La luce emanata è solo bianca.
The light emitted is white like.

B  La luce emanata cambia colore al variare della temperatura
Azzurro: fino a 32°
Bianco: da 32° a 38°
Rosa: oltre 38°
*The light emitted changes colour with temperature
Light Blue: up to 32°
White: from 32° to 38°
Pink: from 38°*

C  La luce emanata cambia colore al variare della temperatura
Blu: fino a 28°
Verde: da 28° a 33°
Giallo: da 33° a 38°
Rosso: da 38°
*The light emitted changes colour with temperature
Blue: up to 28°
Green: from 28° to 33°
Yellow: from 33° to 38°
Red: from 38°*

D  Un arcobaleno di colori e sfumature si alternano creando un continuo gioco emozionale
A rainbow of colors and shades alternate, creating a constant emotional game

Le temperature indicate possono variare di circa +/-2 gradi a seconda delle caratteristiche del miscelatore e dell'ambiente.
I modelli A B e D oltre i 40° emaneranno luce di colore rosso come protezione.

The indicated temperatures may vary approximately by +/-2 degrees, depending on the mixer and the environment characteristics.
Over 40° models A B and D will emit red light as protection.

LAVABI E BIDET - WASHBASIN MIXERS AND BIDET



Monocomando lavabo con luce led.
Altezza: 19,4 cm - Interasse: 10 cm
*Single-lever basin mixer with led light.
Height: 19,4 cm - Interaxis: 10 cm.*



OXL605 con scarico.
with pop-up waste.

OXL606 senza scarico.
without waste.



Monocomando lavabo alto con luce led.
Altezza: 31,5 cm - Interasse: 11,8 cm
*High Washbasin mixer with led light.
Height: 31,5 cm - Interaxis: 11,8 cm.*



OXL607 con scarico click clack.
with click clack waste.

OXL607BA senza scarico.
without waste.



Monocomando lavabo XL con luce led.
Altezza: 47,6 cm - Interasse: 11,8 cm
*XL Washbasin mixer with led light.
Height: 47,6 cm - Interaxis: 11,8 cm.*



OXL607X con scarico click clack.
with click clack waste.

OXL607XBA senza scarico.
without waste.



OXL688

Miscelatore monocomando lavabo da pavimento con click-clack e troppo pieno.
Altezza bocca: 95 cm - Interasse: 11,8 cm
*Single-lever mixer floor mounting with click-clack and overflow.
Height spout: 95 cm - Interaxis: 11,8 cm.*



Monocomando bidet.
Altezza: 17 cm - Interasse: 9,4 cm
*Single-lever bidet mixer.
Height: 17 cm - Interaxis: 9,4 cm.*

OXL604 con scarico.
with pop-up waste.

OXL604B senza scarico.
without waste.

INCASSI DOCCIA E BOCCHIE - BUILT-IN MIXERS AND SPOUTS



OX23602
Miscelatore doccia incasso.
Single-lever built-in shower mixer.



OX23612
Miscelatore vasca incasso con deviatore.
Built-in bath/shower mixer with diverter.



OXL4704
Bocca incasso con luce led.
Built-in spout with led light.
CE 

MISCELATORI VASCA E DOCCIA - SHOWER AND BATH MIXERS



Miscelatore vasca esterno con luce led.
Exposed bath mixer with led light.
CE 

OXL610 con kit doccia, flessibile 150 cm.
with shower kit, flexible 150 cm.

OXL600 con kit doccia, flessibile 120 cm.
with shower kit, flexible 120 cm.

OXL600H senza kit doccia.
without shower kit.

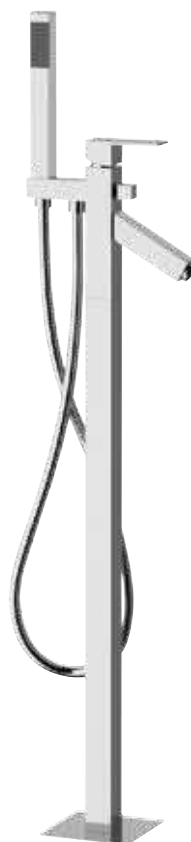

OXL678
Miscelatore vasca da pavimento con luce led con deviatore e kit doccia.
Altezza bocca: 80 cm - Interasse: 11,8 cm.
Free standing bath mixer floor mounting with led light with diverter and shower kit.
Height spout: 80 cm - Interaxis: 11,8 cm.

CE 



Monocomando doccia esterno.
Exposed shower mixer.

OX23611A con kit doccia
with shower kit

OX23611 senza kit doccia.
without shower kit.



OXL691

Miscelatore monocomando bordo
vasca con bocca con luce led.
*Single lever deck bath/shower mixer
with led light spout*





COLONNE DA SOFFITTO CEILING COLUMN





FINISHINGS

FIN 2

- | | | | | |
|--|---|---|---------------------------------------|-------------------------------------|
| CP cromo spazzolato
brushed chrome | NP nichel spazzolato
brushed nickel | NPO nichel spazzolato opaco
matt brushed nickel | 63 vecchio ottone
old brass | OIL oil bronze
oil bronze |
| 64 vecchio rame
old copper | 14 bianco opaco
matt white | 15 nero opaco
matt black | | |

FIN 4

- | | | | | | |
|------------------------------------|--|---------------------------------------|--|---|-------------------------------|
| DO oro lucido
shiny gold | DP oro spazzolato
brushed gold | RL rame lucido
shiny copper | FZ cromo nero spazzolato lucido
shiny brushed black chrome | CF cromo nero lucido
shiny black chrome | GO grafite
graphite |
|------------------------------------|--|---------------------------------------|--|---|-------------------------------|

FIN 5

- | | | |
|--|--|---|
| PG oro rosa lucido
shiny pink gold | PP oro rosa spazzolato
brushed pink gold | RPO rame anodizzato
anodised copper |
|--|--|---|

Finiture consigliate per questa collezione.
Per l'elenco completo fare riferimento alla tabella delle finiture (pag.04)

*Suggested finishes for this collection.
For a complete list of available colors, please refer to the finishing table (page 04)*

DECORI DISPONIBILI:
AVAILABLE DECORATIONS:

SPIRAL YC



DECO 2

- | |
|--|
| YC86 nichel spazzolato, decoro canna di fucile spazzolato.
brushed nickel, brushed gun barrel decoration.. |
|--|

- | |
|--|
| YC97 nichel spazzolato, decoro nichel lucido.
brushed nickel, shiny nickel decoration, |
|--|

DECO 3

- | |
|---|
| YC90 vecchio ottone decoro oro lucido.
old brass shiny gold decoration. |
|---|

DECO 4

- | |
|---|
| YC85 nichel spazzolato, decoro oro spazzolato.
brushed nickel, brushed gold decoration. |
|---|

- | |
|---|
| YC95 canna di fucile spazzolato, decoro cromo.
brushed gun barrel, chrome decoration. |
|---|

- | |
|--|
| YC98 ottone spazzolato decoro ottone lucido.
brushed brass shiny brass decoration. |
|--|

DECO 5

- | |
|--|
| YC88 oro antico, decoro canna di fucile spazzolato.
antique gold, brushed gun barrel decoration. |
|--|

- | |
|---|
| YC96 oro spazzolato, decoro cromo.
brushed gold, chrome decoration. |
|---|

DECO 6

- | |
|--|
| YC14 Bianco Opaco
Matt White |
|--|

- | |
|--------------------------------------|
| YC15 Nero Opaco
Matt Black |
|--------------------------------------|

DEKORA

SENSE

BOCCHIE A SOFFITTO - CEILING COLUMN

MISCELATORE DA SOFFITTO - CEILING MIXER



Miscelatore da soffitto in ottone cromato, con miscelazione e controllo flusso integrati nella bocca di erogazione.
Ceiling mixer in chrome plated brass, with mixing and flow control integrated in the outlet spout.

SL20703 lunghezza 166 cm e dispositivo color.
length 166 cm and colour device.

SL20703X lunghezza 181 cm e dispositivo color.
length 181cm and colour device.

SL20703XL lunghezza 231 cm e dispositivo color.
length 231cm and colour device.



Miscelatore da soffitto in ottone cromato, con miscelazione e controllo flusso integrati nella bocca di erogazione.
Ceiling mixer in chrome plated brass, with mixing and flow control integrated in the outlet spout.

S20703 lunghezza 166 cm.
length 166 cm.

S20703X lunghezza 181 cm.
length 181 cm.

S20703XL lunghezza 231 cm.
length 231 cm.

BOCCHIE - SPOUTS



Bocca da soffitto in ottone cromato con dispositivo color.
Ceiling spout in chrome plated brass with colour device.

SL204706 lunghezza 166 cm e dispositivo color.
length 166 cm and colour device.

SL204706X lunghezza 181 cm e dispositivo color.
length 181 cm and colour device.



Bocca da soffitto in ottone cromato.
Ceiling spout in chrome plated brass.

S204706 lunghezza 166 cm.
length 166 cm.

S204706X lunghezza 181 cm.
length 181 cm.

SKYLINE
AMBIENT

CUBE
WATERFALL

OXY
LIGHT

BOCCHIE A
SOFFITTO
CEILING
COLUMN





CRYSTAL

CRYSTAL è una collezione di rubinetteria classica bicomando che celebra un ambiente sofisticato ed elegante.

Le manopole dei rubinetti sono infatti impreziosite da cristalli Swarovski che illuminano tutta la serie con la loro inconfondibile brillantezza.

Qui proposta in abbinamento alla finitura oro lucido (DO), la serie CRYSTAL può essere personalizzata in base agli arredi e seguendo le diverse colorazioni a catalogo.

CRYSTAL is a classic collection of dual-control taps that celebrates a sophisticated and elegant context.

The faucets knobs are indeed embellished with Swarovski crystals that illuminate the whole collection with their typical brilliance.

Here proposed in combination with the shiny gold finishing (DO), CRYSTAL series can be customized according to the furniture and following the different colorings in the catalog.

FINISHINGS

CP cromo spazzolato
brushed chrome

64 vecchio rame
old copper

DO oro lucido
shiny gold

GO grafite
graphite

PG oro rosa lucido
shiny pink gold

NP nichel spazzolato
brushed nickel

14 bianco opaco
matt white

DP oro spazzolato
brushed gold

PP oro rosa spazzolato
brushed pink gold

FIN 2

NPO nichel spazzolato opaco
matt brushed nickel

15 nero opaco
matt black

FZ cromo nero spazzolato lucido
shiny brushed black chrome

63 vecchio ottone
old brass

OIL oil bronze
oil bronze

FIN 4

CF cromo nero lucido
shiny black chrome

RL rame lucido
shiny copper

FIN 5

RPO rame anodizzato
anodised copper

Finiture consigliate per questa collezione.
Per l'elenco completo fare riferimento alla tabella delle finiture (pag.04)

*Suggested finishes for this collection.
For a complete list of available colors, please refer to the finishing table (page 04)*



CRYSTAL

CRYSTAL
RETRO

REVIVAL

DEKORA
SENSE

RETRO

LIFE

DEKORA

MISS

DEKORA

TIME



TICINO

CRYSTAL

CARATTERISTICHE TECNICHE:

Leve con cristallo Swarovski.
La serie è dotata di vitone ceramico,
prodotto da S.T.S.R. Studio Tecnico Sviluppo e Ricerche
www.stsr.it

TECHNICAL CHARACTERISTICS:

Levers with swarovski crystal.
The series is equipped with ceramic headvalves,
produced by S.T.S.R. - Research Development Technical Office
www.stsr.it

LAVABI - WASHBASIN MIXERS



CY5112DO

Monoforo lavabo con scarico.
Altezza: 15 cm - Interasse: 12,5 cm.
One hole washbasin mixer with pop-up waste.
Height: 15 cm - Interaxis: 12,5 cm.



CY5112LDO

Monoforo lavabo con scarico click-clack.
Altezza: 17,5 cm - Interasse: 13 cm.
One hole washbasin mixer with click-clack waste.
Height: 17,5 cm - Interaxis: 13 cm.



CY5116DO

Monoforo lavabo con canna tubo e scarico.
Altezza: 30 cm - Interasse: 18,5 cm.
One hole washbasin mixer with tube spout and pop-up waste.
Height: 30 cm - Interaxis: 18,5 cm.



CY5003DO

Batteria lavabo con scarico.
Altezza: 15 cm - Interasse: 13 cm.
Washbasin set with pop-up waste.
Height: 15 cm - Interaxis: 13 cm.



BIDET - BIDET MIXERS



CY6200DO

Monoforo bidet con scarico.
Altezza: 7 cm - Interasse: 10 cm.
One hole bidet mixer with pop-up waste.
Height: 7 cm - Interaxis: 10 cm.



CY6302DO

Batteria bidet con scarico.
Altezza bocca: 5,5 cm - Interasse: 10 cm.
Three holes bidet set with pop-up waste.
Height spout: 5,5 cm - Interaxis: 10 cm.



S20642DO

Miscelatore incasso per shut-off con doccetta shut-off, supporto doccia, presa acqua
Built-in shut-off mixer set with shut-off, shower holder, water punch.

MISCELATORI VASCA E DOCCIA - SHOWER AND BATH MIXERS



Gruppo vasca esterno.
Bathtub mixer.

CY4302DO

con kit doccia, doccia duplex e flessibile 150 cm.
with duplex shower kit and flexible 150 cm.

CY4300DO

con kit doccia, doccia duplex e flessibile 120 cm.
with duplex shower kit and flexible 120 cm.

CY4300HDO

senza kit doccia.
without shower kit.



CY4491DO

Batteria bordo vasca con doccia estraibile.
Bathtub set with pull-out shower.



CY4492DO

Miscelatore bordo vasca quattro fori.
Deck bath set with diverter.



CY4440DO

Batteria vasca incasso con deviatore completa di set doccia e bocca a incasso.
Built-in bathtub mixer with diverter complete of shower kit and built-in spout.



CY444189DO

Batteria vasca incasso con deviatore, presa acqua con flessibile cm 150 e doccetta ad 1 funzione e braccio doccia con soffione.
Tutto in ottone cromato.
Built-in bathtub mixer with diverter, water punch/shower holder with flexible cm 150 and 1 function handshower, shower arm with shower head. All in brass.

CRYSTAL

CRYSTAL
RETRO

REVIVAL

DEKORA
SENSE

RETRO

LIFE

DEKORA

MISS

DEKORA

TIME

TICINO

CRYSTAL



Gruppo doccia esterno.
Wall-mounted shower mixer.

CY4433ADO

con kit doccia.
with shower kit.

CY4433DO

senza kit doccia.
without shower kit.



CY4433ZDO

Gruppo doccia esterno, attacco
3/4 per colonna doccia.
Wall mounted shower mixer with
connection 3/4 for columns.

ACCESSORI - ACCESSORIES



A705LITCCDO

Colonna di scarico con sifone per vasca con
tubo in rame cromato e piletta click-clack,
tutta cromata.

*Bath brass waste with siphon, trap chrome
plated, copper tube and click clack waste, all
chrome plated.*



A705LITDO

Colonna di scarico con sifone per vasca con
tubo in rame cromato, tutta cromata.

*Bath brass waste with siphon, trap and chrome
plated copper tube, all in chrome plated.*



A735DO

Scarico automatico con sistema click-clack,
1"1/4, e tappo grande, senza troppo pieno.
*Automatic pop-waste, click-clack system,
1"1/4, big plug, without overflow.*



A736DO

Scarico automatico con sistema click-clack,
1"1/4, e tappo grande, con troppo pieno.
*Automatic pop-waste, click-clack system,
1"1/4, big plug, with overflow.*



A750DO

Sifone minimale in ottone cromato
1"1/4.
C.P. brass minimal P trap 1"1/4.



A765DO

Sifone a bottiglia, canotto cm 25 in
ottone cromato, 1" - 1" 1/4.
*Bottle trap, 25 cm outlet tube in
c.p. brass, 1" - 1" 1/4.*



CY4454DO
Rubinetto doccia incasso 1/2.
Built-in right valve 1/2.



CY9200DO
Maniglia Crystal.
Crystal handle.

COLONNE DOCCIA - SHOWER COLUMN



CY443789DO
Gruppo doccia con colonna girevole e soffione tutto in ottone.
Shower mixer with column and shower head all in brass.



CY443689DO
Gruppo doccia con colonna saliscendi girevole con deviatore doccetta, flessibile e soffione.
Shower mixer with sliding rail column with diverter shower, flexible and shower head.

CRYSTAL

CRYSTAL
RETRO

REVIVAL
DEKORA
SENSE

RETRO

LIFE
DEKORA

MISS
DEKORA

TIME

TICINO

CUCINA - KITCHEN



CY7005DO
Gruppo lavello a muro con canna fusa alta.
Altezza canna: 17,5 cm - Interasse: 12,3 cm.
*Wall-mounted sink set with high casted spout.
Spout height: 17,5 cm - Interaxis: 12,3 cm.*



CY7004DO
Gruppo lavello a muro con canna fusa a "S".
Lunghezza canna: 18,5 cm.
*Wall-mounted sink set with "S" casted spout.
Lenght spout: 18,5 cm.*



CY7100DO
Monoforo lavello con bocca girevole.
Altezza: 28 cm - Interasse: 19 cm.
*One hole sink mixer with swiveling spout.
Height: 28 cm - Interaxis: 19 cm.*



CRYSTAL RETRÓ

La collezione CRYSTAL RETRÓ propone una rubinetteria bicomando dedicata ad un gusto antico e principesco. Tutta l'eleganza classica della serie viene arricchita da maniglie in cristallo Swarovski, creando un prezioso gioco di riflessi e trasparenze. Qui proposta in abbinamento alla colorazione oro lucido (DO), CRYSTAL RETRÓ può essere personalizzata in base agli arredi secondo le diverse finiture a catalogo.

CRYSTAL RETRÓ presents a dual-control taps collection dedicated to an ancient and princely taste. All the classic elegance of the series is enriched with Swarovski crystal handles, creating a precious play of reflections and transparencies. Here proposed in combination with the shiny gold coloring (DO), CRYSTAL RETRÓ can be customized according to the furniture and following the different finishings in the catalog.

FINISHINGS

CP cromo spazzolato brushed chrome

64 vecchio rame old copper

DO oro lucido shiny gold

GO grafite graphite

NP nichel spazzolato brushed nickel

14 bianco opaco matt white

DP oro spazzolato brushed gold

FIN 5
PG oro rosa lucido shiny pink gold

FIN 2
NPO nichel spazzolato opaco matt brushed nickel

15 nero opaco matt black

FIN 4
FZ cromo nero spazzolato lucido shiny brushed black chrome

RPO rame anodizzato anodised copper

63 vecchio ottone old brass

OIL oil bronze oil bronze

CF cromo nero lucido shiny black chrome

RL rame lucido shiny copper

Finiture consigliate per questa collezione.
Per l'elenco completo fare riferimento alla tabella delle finiture (pag.04)

*Suggested finishes for this collection.
For a complete list of available colors, please refer to the finishing table (page 04)*



CLASSICA
CLASSIC

CRYSTAL

CRYSTAL
RETRO

REVIVAL

DEKORA
SENSE

RETRO

LIFE

DEKORA

MISS

DEKORA

TIME



TICINO

CARATTERISTICHE TECNICHE:
 Leve con cristallo Swarovski.
 La serie è dotata di vitone ceramico,
 prodotto da S.T.S.R. Studio Tecnico Sviluppo e Ricerche
 www.stsr.it

TECHNICAL CHARACTERISTICS:
 Levers with Swarovski crystal.
 The series is equipped with ceramic headvalves,
 produced by S.T.S.R. - Research Development Technical Office
 www.stsr.it

LAVABI - WASHBASIN MIXERS



RYV605DO
 Miscelatore monocomando lavabo con scarico.
 Altezza: 17 cm - Interasse: 11 cm
Single lever washbasin mixer with pop-up waste.
 Height: 17 cm - Interaxis: 11 cm.



RY5400DO
 Monoforo lavabo con canna antica e scarico.
 Altezza: 23,5 cm - Interasse: 23 cm
One hole washbasin mixer with "Antique" spout and pop-up waste.
 Height: 23,5 cm - Interaxis: 23 cm.



RY5003LDO
 Batteria lavabo con canna fusa corta e scarico.
 Altezza: 15 cm - Interasse: 13 cm
Three holes washbasin mixer with casted spout and pop-up waste.
 Height: 15 cm - Interaxis: 13 cm.



RY5104DO
 Batteria lavabo con canna antica e scarico.
 Altezza: 26,5 cm - Interasse: 19 cm
Washbasin set with "Antique" spout and pop-up waste.
 Height: 26,5 cm - Interaxis: 19 cm.



RY5112LDO
 Monoforo lavabo con scarico click-clack.
 Altezza: 17,5 cm - Interasse: 13 cm
One hole washbasin mixer with click-clack pop-up waste.
 Height: 17,5 cm - Interaxis: 13 cm.



RY5003DO
 Batteria lavabo con scarico.
 Altezza bocca: 5,5 cm - Interasse: 14 cm
Washbasin set with pop-up waste.
 Height spout: 5,5 cm - Interaxis: 14 cm.

BIDET - BIDET MIXERS



RYV604DO
 Miscelatore monocomando bidet con scarico.
 Altezza: 17 cm - Interasse: 11 cm
Single lever bidet mixer with pop-up waste.
 Height: 17 cm - Interaxis: 11 cm.



RY6400DO
 Monoforo bidet canna antica con scarico.
 Altezza: 14,5 cm - Interasse: 15,5 cm
One hole bidet mixer with "Antique" spout and pop-up waste.
 Height: 14,5 cm - Interaxis: 15,5 cm.



RY6302DO
 Batteria bidet con scarico.
 Altezza: 8,5 cm - Interasse: 10 cm
Three holes bidet set with pop-up waste.
 Height: 8,5 cm - Interaxis: 10 cm.



RY6004DO
 Batteria bidet con canna antica e scarico.
 Altezza: 18 cm - Interasse: 11,5 cm
Bidet set with "Antique" spout and pop-up waste.
 Height: 18 cm - Interaxis: 11,5 cm.



RY6200DO
 Monoforo bidet con scarico.
 Interasse: 11,5 cm
One hole bidet mixer with pop-up waste.
 Interaxis: 11,5 cm.



RY4102DO

Gruppo vasca esterno con kit doccia, doccia e flessibile 120 cm.
Bathtub mixer with shower kit and flexible 120 cm.



RY4102UKDO

Gruppo vasca esterno su colonnette alte con flessibile cm 120 e doccia normale.
Bathtub mixer on high studs with flexible cm 120 and normal shower.

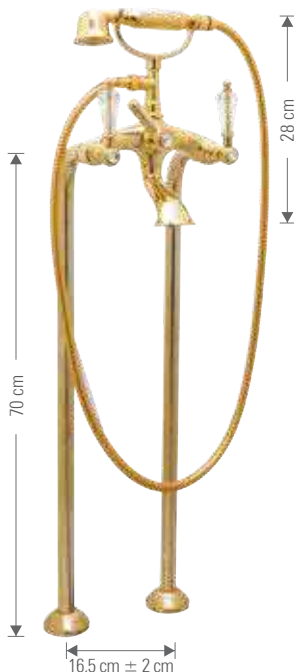

RY4102XLDO

Gruppo vasca esterno su colonne da pavimento, con doccia.
Altezza bocca: 60 cm.
*Traditional bathtub mixer, on floor columns, with shower.
Height spout: 60 cm.*



RY4192DO

Batteria bordo vasca con doccia estraibile.
Bathtub set with pull-out shower.



RY4433ADO

con kit doccia.
with shower kit.

RY4433DO

senza kit doccia.
without shower kit.

Gruppo doccia esterno.
Wall-mounted shower mixer.



RY4433ZDO

Gruppo doccia esterno attacco 3/4 per colonna doccia.
Wall-mounted shower mixer connection 3/4 for columns.



RY4100ZDO

Gruppo vasca con deviatore e attacco 3/4M.
Bathtub mixer with diverter and 3/4M connection.

CRYSTAL

CRYSTAL
RETRO

REVIVAL

DEKORA
SENSE

RETRO

LIFE
DEKORA

MISS
DEKORA

TIME

TICINO



RY413689DO

Gruppo vasca con colonna saliscendi girevole e deviatore con doccia, flessibile e soffione tutto in ottone cromato.
Bathtub mixer with sliding rail column and diverter with shower, flexible and shower head all in brass.



RY443689DO

Gruppo doccia con colonna saliscendi girevole e deviatore con doccia, flessibile e soffione tutto in ottone cromato.
Shower mixer with sliding rail column and diverter with shower, flexible and shower head all in brass.



RY109DO

Gruppo doccia con colonna girevole e soffione tutto in ottone cromato.
Shower mixer with swivelling column and shower head all in brass.



RY9200DO

Maniglia Crystal Retrò.
Crystal Retrò handle.

INCASSI DOCCIA - BUILT-IN MIXERS



RY602DO

Miscelatore monocomando doccia incasso.
Single lever built-in shower mixer.



RY612DO

Miscelatore monocomando vasca/doccia incasso con deviatore.
Single lever built-in bath/shower mixer with diverter.

CRYSTAL

CUCINA - KITCHEN



RY7007DO

Gruppo lavello a muro con canna antica.
Altezza: 21,5 cm - Interasse: 23,5 cm
*Wall-mounted sink set with "Antique" spout.
Height: 21,5 cm - Interaxis: 23,5 cm.*



RY7114DO

Monoforo lavello con canna antica.
Altezza: 24 cm - Interasse: 23,5 cm
*One hole sink mixer with "Antique" spout.
Height: 24 cm - Interaxis: 23,5 cm.*

CRYSTAL
RETRO

REVIVAL

DEKORA
SENSE

RETRO

LIFE

DEKORA

MISS

DEKORA

TIME



RY618DO

Miscelatore monocomando cucina con canna antica.
Altezza: 28 cm - Interasse: 23,5 cm
*Single lever kitchen mixer with "Antique" spout.
Height: 28 cm - Interaxis: 23,5 cm.*

TICINO





REVIVAL

La collezione Revival rappresenta l'espressione più classica tra le serie di Daniel Rubinetterie. Miscelatori bicomando in cui il gusto e l'eleganza delle forme si fonde armoniosamente con la più raffinata tradizione. L'ampia possibilità di finiture permette inoltre di scegliere la combinazione più adatta ad arricchire ogni singolo progetto, accentuando i toni antichi negli ambienti dal gusto retrò o sperimentando nuovi abbinamenti con le tinte degli arredi moderni.

REVIVAL collection represents the most classical expression between Daniel Rubinetterie series. Double-lever mixers in which the shapes taste and elegance harmoniously blends with the finest tradition. The wide range of finishes allows also to choose the most suitable combination to enrich every single project, highlighting the ancient tones in "retro" environments or experimenting new colors combinations with modern furniture tints.

FINISHINGS

FIN 1					
11CR bianco raal/cromo white raal/chrome	CRDO cromo/oro chrome/gold	110T bianco raal/ottone white raal/brass	01 bianco lucido shiny white	07 nero lucido shiny black	11 bianco raal white raal
11DO bianco raal/oro white raal/gold	07DO nero lucido/oro shiny black/gold	07CR nero lucido/cromo shiny black/chrome			
FIN 2					
NPO nichel spazzolato opaco matt brushed nickel	64 vecchio rame old copper	OIL oil bronze oil bronze	CP cromo spazzolato brushed chrome	NP nichel spazzolato brushed nickel	63 vecchio ottone old brass
SM ottone s. marco s. marco brass	OT ottone lucido shiny brass	15CR nero opaco/cromo matt black/chrome	OP ottone spazzolato brushed brass	14 bianco opaco matt white	15 nero opaco matt black
OM v. ottone opaco matt old brass	NPCR nichel spazz./cromo brushed nickel/chrome				
FIN 4					
FZ cromo nero spazzolato lucido shiny brushed black chrome	CF cromo nero lucido shiny black chrome	GO grafite graphite	DO oro lucido shiny gold	DP oro spazzolato brushed gold	RL rame lucido shiny copper
88 oro antico old gold	EG oro inglese english gold	CFDO cromo nero lucido/ oro lucido shiny black chrome/ shiny gold			
FIN 5					
PG oro rosa lucido shiny pink gold	PP oro rosa spazzolato brushed pink gold	RPO rame anodizzato anodised copper			

Finiture consigliate per questa collezione.
Per l'elenco completo fare riferimento alla tabella delle finiture (pag.04)

*Suggested finishes for this collection.
For a complete list of available colors, please refer to the finishing table (page 04)*



DECORI DISPONIBILI:
AVAILABLE DECORATIONS:

SPIRAL YC



DECO 2



YC85 nichel spazzolato, decoro oro spazzolato
brushed nickel, brushed gold decoration



YC86 nichel spazzolato, decoro canna di fucile spazzolato.
brushed nickel, brushed gun barrel decoration..



YC97 nichel spazzolato, decoro nichel lucido.
brushed nickel, shiny nickel decoration,

DECO 3



YC90 vecchio ottone decoro oro lucido.
old brass shiny gold decoration.



YC91 vecchio ottone, decoro ottone scuro
old brass, dark brass decoration



YC92 vecchio rame, decoro rame lucido
old copper, shiny copper decoration



YC93 vecchio rame, decoro rame scuro
old copper, dark copper decoration

DECO 4



YC95 canna di fucile spazzolato, decoro cromo.
brushed gun barrel, chrome decoration.



YC98 ottone spazzolato, decoro ottone lucido
brushed brass, shiny brass decoration

DECO 5



YC88 oro antico, decoro canna di fucile spazzolato.
antique gold, brushed gun barrel decoration.



YC96 oro spazzolato, decoro cromo.
brushed gold, chrome decoration.

DECO 6



YC14 Bianco Opaco
Matt White



YC15 Nero Opaco
Matt Black

CARATTERISTICHE TECNICHE:

La serie è dotata di vitone ceramico,
prodotto da S.T.S.R. Studio Tecnico Sviluppo e Ricerche - www.stsr.it

TECHNICAL CHARACTERISTICS:

The series is equipped with ceramic headvalves,
produced by S.T.S.R. - Research Development Technical Office - www.stsr.it

MANIGLIE DISPONIBILI:
AVAILABLE HANDLES:



diamond



signed

LAVABI - WASHBASIN MIXERS



V5400

Monoforo lavabo con canna antica e scarico.
Altezza: 23,5 cm - Interasse: 23 cm
One hole washbasin mixer with "Antique" spout and pop-up waste.
Height: 23,5 cm - Interaxis: 23 cm.



V5104

Batteria lavabo con canna antica e scarico.
Altezza: 26,5 cm - Interasse: 19 cm
Washbasin set with "Antique" spout and pop-up waste.
Height: 26,5 cm - Interaxis: 19 cm.



V5116

Monoforo lavabo con canna tubo e scarico.
Altezza: 31 cm - Interasse: 19 cm
One hole washbasin mixer with tube spout and pop-up waste.
Height: 31 cm - Interaxis: 19 cm.



V5100

Batteria lavabo con bocca alta e scarico.
Altezza: 31 cm - Interasse: 19 cm
Washbasin set with swiveling high spout and pop-up waste.
Height: 31 cm - Interaxis: 19 cm.



V605

Miscelatore monoforo lavabo con scarico.
Altezza: 15,6 cm - Interasse: 11,5 cm
One hole single lever washbasin mixer with pop-up waste.
Height: 15,6 cm - Interaxis: 11,5 cm.



V5003L

Batteria lavabo con canna fusa corta e scarico.
Altezza: 16 cm - Interasse: 12,5 cm
Three holes washbasin mixer with casted spout and pop-up waste.
Height: 16 cm - Interaxis: 12,5 cm.



V5118

Monoforo lavabo con canna fusa corta e scarico.
Altezza: 20 cm - Interasse: 12,5 cm
One hole washbasin mixer with short casted spout and pop-up waste.
Height: 20 cm - Interaxis: 12,5 cm.



V5112L

Monoforo lavabo con scarico click-clack.
Altezza: 17,5 cm - Interasse: 13 cm
One hole washbasin mixer with click-clack pop-up waste.
Height: 17,5 cm - Interaxis: 13 cm.

**V5003**

Batteria lavabo con scarico.
Altezza: 9 cm - Interasse: 14 cm
Washbasin set with pop-up waste.
Height: 9 cm - Interaxis: 14 cm.

**V5112**

Monoforo lavabo con scarico.
Altezza: 10 cm - Interasse: 13 cm
One hole washbasin mixer with pop-up waste.
Height: 10 cm - Interaxis: 13 cm.

**V5022**

Batteria lavabo/lavello da incasso.
Lunghezza bocca: 20 cm.
Concealed basin/sink mixer.
Length spout: 20 cm.

CRYSTAL

CRYSTAL
RETRO

REVIVAL

DEKORA
SENSE

BIDET

RETRO

LIFE

DEKORA

MISS

DEKORA

TIME

TICINO

**V6300**

Batteria bidet con scarico e doccia.
Bidet set with pop-up waste and shower.

**V6400**

Monoforo bidet canna antica e scarico.
Altezza: 14,5 cm - Interasse: 15,5 cm
One hole bidet mixer with "Antique" spout and pop-up waste.
Height: 14,5 cm - Interaxis: 15,5 cm.

**V6302**

Batteria bidet con scarico.
Altezza: 7,5 cm - Interasse: 11 cm
Three holes bidet set with pop-up waste.
Height: 7,5 cm - Interaxis: 11 cm.

**V6200**

Monoforo bidet con scarico.
Altezza: 11,5 cm - Interasse: 11,5 cm
One hole bidet mixer with pop-up waste.
Height: 11,5 cm - Interaxis: 11,5 cm.

**V604**

Miscelatore monoforo bidet con scarico.
Altezza: 15,6 cm - Interasse: 11,5 cm
One hole single lever bidet mixer with pop-up waste.
Height: 15,6 cm - Interaxis: 11,5 cm.

**V6004**

Batteria bidet canna antica con scarico.
Altezza: 18 cm - Interasse: 17 cm
Three holes bidet mixer with "Antique" spout and pop-up waste.
Height: 18 cm - Interaxis: 17 cm.

**V6080**

Combinazione bidet senza scarico.
Bidet supply fitting without waste.

**V6030**

Combinazione bidet con scarico.
Bidet supply fitting with pop-up waste.

MISCELATORI VASCA E DOCCIA - SHOWER AND BATH MIXERS



Gruppo vasca esterno.
Bathtub mixer.

V4101 con kit doccia, doccia duplex e flessibile 150 cm.
with shower kit, duplex shower and flexible 150 cm.

V4102 con kit doccia, doccia e flessibile 120 cm.
with shower kit and flexible 120 cm

V4100Z Gruppo vasca con deviatore e attacco 3/4M.
Bathtub mixer with diverter and 3/4M connection.



V4101UK

Gruppo vasca esterno su colonnette alte con flessibile cm 150 e doccia duplex.
Bathtub mixer on high studs with flexible cm 150 and duplex shower.



V4192

Batteria bordo vasca con doccia estraibile.
Bathtub set with pull-out shower.

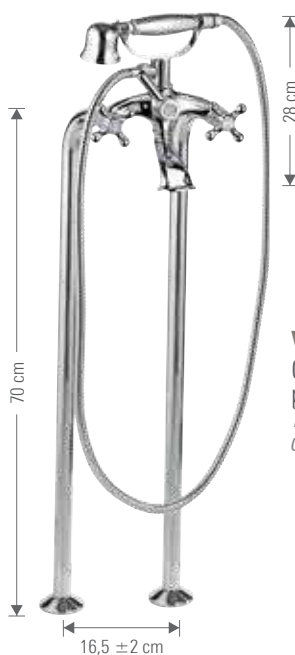

V4101XL

Gruppo vasca esterno su colonne da pavimento, con doccia.
Traditional bathtub mixer, on floor columns, with shower.

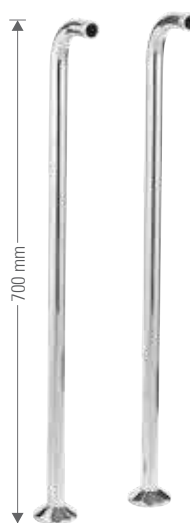

A880XL

Colonne da pavimento.
Floor columns.



CRYSTAL

CRYSTAL
RETRO

REVIVAL
DEKORA
SENSE

RETRO

LIFE
DEKORA

MISS
DEKORA

TIME

TICINO



V444189

Batteria vasca incasso con deviatore composta da presa acqua con flessibile e doccetta, braccio doccia con soffione, tutto in ottone cromato.
Built-in bathtub mixer with diverter composed by water connector with flexible and handshower, shower arm with shower head, all in c.p. brass.



V4440

Batteria vasca incasso con deviatore composta da presa acqua con flessibile e doccetta, bocca, tutto in ottone cromato.
Built-in bathtub mixer with diverter composed by water connector with flexible and handshower, spout, all in c.p. brass.



Miscelatore lavabo/vasca con canna "S" cm 30 e deviatore.
Exposed basin/bath mixer with "S" spout cm 30 and diverter.

V7623S con kit doccia.
with duplex shower.

V7623SH senza kit doccia.
without shower kit.



Gruppo doccia esterno.
Wall-mounted shower mixer.

V4433A con kit doccia.
with duplex shower.

V4433 senza kit doccia.
without shower kit.



Saliscendi Revival.
Revival sliding rail.

A308 404 cm 60 con asta tonda Ø 25 mm e doccetta completamente in ottone cromato.
round rod Ø 25 mm lenght cm 60 with handshower completely in CP brass.

A398 404 cm 90 con asta tonda Ø 25 mm e doccetta completamente in ottone cromato.
round rod Ø 25 mm lenght cm 90 with handshower completely in CP brass.



V4306

Gruppo vasca esterno con doccia e canna lunga girevole, lunghezza 40 cm.
Bathtub mixer with shower and long movable spout, lenght 40 cm.



V4433Z

Gruppo doccia esterno attacco 3/4 per colonna doccia.
Wall-mounted shower mixer connection 3/4 for columns.

BOCCHIE E ACCESSORI - SPOUTS & ACCESSORIES



A705LICC

Colonna di scarico con sifone per vasca con tubo in rame cromato e piletta click-clack, tutta cromata.
Bath brass waste with siphon, trap chrome plated, copper tube and click clack waste, all chrome plated.



A705LIT

Colonna di scarico con sifone per vasca con tubo in rame cromato, tutta cromata.
Bath brass waste with siphon, trap and chrome plated copper tube, all in chrome plated.

CRYSTAL

CRYSTAL
RETRO

REVIVAL

DEKORA
SENSE

RETRO

LIFE

DEKORA

MISS

DEKORA

TIME

TICINO



L4704

Bocca incasso.
Built-in spout.



V9200

Maniglia Revival.
Revival handle.



V4454

Rubinetto doccia incasso 1/2.
Built-in right valve 1/2.

INCASSI DOCCIA - BUILT-IN MIXERS



V602

Miscelatore monocomando doccia incasso.
Single lever built-in shower mixer.



V612

Miscelatore monocomando vasca/doccia incasso con deviatore.
Single lever built-in bath/shower mixer with diverter.

BOX INCASSO - BUILT-IN BOX

V602KB

Set miscelatore doccia da abbinare al box incasso.
Shower mixer set to match with the built-in box.



DAN BOX

Box da incasso per miscelatore doccia con deviatore.
Built-in box for shower mixer with diverter.

V612KB

Set miscelatore doccia con deviatore da abbinare al box incasso.
Shower mixer set with diverter to match with the built-in box.



DAN BOX

Box da incasso per miscelatore doccia con deviatore.
Built-in box for shower mixer with diverter.

COLONNE DOCCIA E VASCA - SHOWER AND BATH COLUMN



V443789
 Gruppo doccia con colonna girevole e soffione tutto in ottone cromato.
Shower mixer with column and shower head all in C.P. brass.



V443689
 Gruppo doccia con colonna saliscendi girevole e deviatore con doccia, flessibile e soffione tutto in ottone cromato.
Shower mixer with sliding rail column and diverter with shower, flexible and shower head all in c.p. brass.

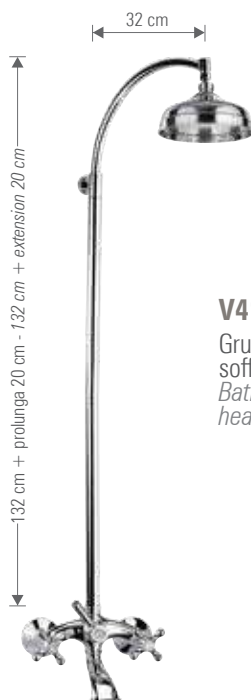

V413789
 Gruppo vasca con colonna girevole e soffione tutto in ottone cromato.
Bathtub mixer with column and shower head all in c.p. brass.



V413689
 Gruppo vasca con colonna saliscendi girevole e deviatore con doccia, flessibile e soffione tutto in ottone cromato.
Bathtub mixer with sliding rail column and diverter with shower, flexible and shower head all in brass.



V7114

Monoforo lavello con canna antica.
Altezza: 23,5 cm - Interasse: 27,5 cm
One hole sink mixer with "Antique" spout.
Height: 23,5 cm - Interaxis: 27,5 cm.



V7112

Monoforo lavello con bocca fusa girevole.
Altezza: 23,5 cm - Interasse: 20,5 cm
One hole sink mixer with swiveling casted spout.
Height: 23,5 cm - Interaxis: 20,5 cm.



V7100

Monoforo lavello con bocca girevole.
Altezza: 28 cm - Interasse: 19 cm
One hole sink mixer with swiveling spout.
Height: 28 cm - Interaxis: 19 cm.



CRYSTAL

CRYSTAL
RETRO

REVIVAL

DEKORA
SENSE

RETRO

LIFE
DEKORA

MISS
DEKORA

TIME

TICINO



V7007
Gruppo lavello a muro con canna antica.
Altezza: 21 cm - Interasse: 23 cm
Wall-mounted sink set with "Antique" spout.
Height: 21 cm - Interaxis: 23 cm.



V7005
Gruppo lavello a muro con canna "J" tubo superiore.
Altezza bocca: 16,5 cm - Interasse: 18 cm.
Wall-mounted sink set with upper "J" spout.
Height spout: 16,5 cm - Interaxis: 18 cm.



V7004
Gruppo lavello a muro con canna tubo a "S".
Lunghezza canna: 18 cm
Wall-mounted sink set with "S" tube lower spout.
Length spout: 18 cm.



V7000
Gruppo lavello a muro con canna superiore.
Lunghezza canna: 17,5 cm
Wall-mounted sink set with "upper" spout.
Length spout: 17,5 cm.

MONOACQUA - SINGLE WATER



V7202
Rubinetto a muro con canna bassa.
Sink tap with lower spout.



V7200U
Rubinetto a muro con canna superiore a "U".
Sink tap with upper "U" spout.



V7200J
Rubinetto a muro con canna superiore a "J".
Sink tap with upper "J" spout.



V7250
Rubinetto a colonnina.
Bar faucet.



V5009
Rubinetto collo a cigno, 1/2, 3/4.
Wash basin pillar tap, 1/2, 3/4.



V7250U
Rubinetto a colonnina con canna superiore a U.
Bar faucet with upper U spout.



V7200

Rubinetto a squadra per lavatrice 1/2"x3/4".
Angle tap for washing machine 1/2"x3/4".



V720012

Rubinetto a squadra per lavatrice 1/2"x1/2".
Angle tap for washing machine 1/2"x1/2".



V7222

Rubinetto prolungato.
Extended tap.



V7230

Rubinetto con portagomma.
Tap with hose union.



V7210

Rubinetto a snodo con attacco lavatrice, 1/2".
Washing machine bibcock, with swiveling spout.



V7212

Rubinetto curvo con uscita da 1/2" e uscita da bocca di erogazione, attacco 1/2" M.
Angle tap with 1/2" output and spout output, 1/2" M connection.

CRYSTAL

CRYSTAL
RETRO

REVIVAL

DEKORA
SENSE

RETRO

LIFE

DEKORA

MISS

DEKORA

TIME

TICINO



RETRO

La collezione Retrò rappresenta un piccolo viaggio in profili e ricordi del passato. La soluzione di arredo ideale per aggiungere una classe di altri tempi ai gesti quotidiani.

The RETRO collection represents a small trip into profiles and memories of the past. The ideal furnishing solution to add a yesteryear class to of to everyday gestures.

FINISHINGS

FIN 1					
11CR bianco raal/cromo white raal/chrome	CRDO cromo/oro chrome/gold	110T bianco raal/ottone white raal/brass	01 bianco lucido shiny white	07 nero lucido shiny black	11 bianco raal white raal
11DO bianco raal/oro white raal/gold	07DO nero lucido/oro shiny black/gold	07CR nero lucido/cromo shiny black/chrome			
FIN 2					
NPO nichel spazzolato opaco matt brushed nickel	64 vecchio rame old copper	OIL oil bronze oil bronze	CP cromo spazzolato brushed chrome	NP nichel spazzolato brushed nickel	63 vecchio ottone old brass
SM ottone s. marco s. marco brass	OT ottone lucido shiny brass	15CR nero opaco/cromo matt black/chrome	OP ottone spazzolato brushed brass	14 bianco opaco matt white	15 nero opaco matt black
OM v. ottone opaco matt old brass	NPCR nichel spazz./cromo brushed nickel/chrome				
FIN 4					
FZ cromo nero spazzolato lucido shiny brushed black chrome	CF cromo nero lucido shiny black chrome	GO grafite graphite	DO oro lucido shiny gold	DP oro spazzolato brushed gold	RL rame lucido shiny copper
88 oro antico old gold	EG oro inglese english gold	CFDO cromo nero lucido/ oro lucido shiny black chrome/ shiny gold			
FIN 5					
PG oro rosa lucido shiny pink gold	PP oro rosa spazzolato brushed pink gold	RPO rame anodizzato anodised copper			

Finiture consigliate per questa collezione.
Per l'elenco completo fare riferimento alla tabella delle finiture (pag.04)

*Suggested finishes for this collection.
For a complete list of available colors, please refer to the finishing table (page 04)*



CLASSICA
CLASSIC

CRYSTAL

CRYSTAL
RETRO

REVIVAL
DEKORA
SENSE

RETRO

LIFE
DEKORA

MISS
DEKORA

TIME



TICINO

CARATTERISTICHE TECNICHE:

La serie è dotata di vitone ceramico,
prodotto da S.T.S.R. Studio Tecnico Sviluppato e Ricerche
www.stsr.it

TECHNICAL CHARACTERISTICS:

The series is equipped with ceramic headvalves,
produced by S.T.S.R. - Research Development Technical Office
www.stsr.it

LAVABI - WASHBASIN MIXERS



RTV605

Miscelatore monocomando lavabo con scarico.
Altezza: 17 cm - Interasse: 11 cm
*Single lever washbasin mixer with pop-up waste.
Height: 17 cm - Interaxis: 11 cm.*



RT5400

Monoforo lavabo con canna antica e scarico.
Altezza: 23,5 cm - Interasse: 23 cm
*One hole washbasin mixer with "Antique" spout and pop-up waste.
Height: 23,5 cm - Interaxis: 23 cm.*



RT5003L

Batteria lavabo con canna fusa corta e scarico.
Altezza: 15 cm - Interasse: 13 cm
*Three holes washbasin mixer with casted spout and pop-up waste.
Height: 15 cm - Interaxis: 13 cm.*



RT5104

Batteria lavabo con canna antica e scarico.
Altezza: 26,5 cm - Interasse: 19 cm
*Washbasin set with "Antique" spout and pop-up waste.
Height: 26,5 cm - Interaxis: 19 cm.*





RT5112L
Monoforo lavabo con scarico click-clack.
Altezza: 17,5 cm - Interasse: 13 cm
One hole washbasin mixer with click-clack pop-up waste.
Height: 17,5 cm - Interaxis: 13 cm.



RT5112
Monoforo lavabo con scarico.
Altezza bocca: 7 cm - Interasse: 13 cm
One hole washbasin mixer with pop-up waste.
Height spout: 7 cm - Interaxis: 13 cm.



RT5003
Batteria lavabo con scarico.
Altezza: 5,5 cm - Interasse: 14 cm
Washbasin set with pop-up waste.
Height: 5,5 cm - Interaxis: 14 cm.



RT5022
Batteria lavabo/lavello da incasso.
Lunghezza canna: 19 cm.
Concealed basin/sink mixer.
Length spout: 19 cm.

CRYSTAL

CRYSTAL
RETRO

REVIVAL

DEKORA
SENSE

BIDET - BIDET MIXERS



RT6200
Monoforo bidet con scarico.
Altezza bocca: 9 cm - Interasse: 11,5 cm
One hole bidet mixer with pop-up waste.
Height spout: 9 cm - Interaxis: 11,5 cm.



RTV604
Miscelatore monocomando bidet con scarico.
Altezza: 17 cm - Interasse: 11 cm
Single lever bidet mixer with pop-up waste.
Height: 17 cm - Interaxis: 11 cm.

RETRO

LIFE

DEKORA



RT6400
Monoforo bidet canna antica con scarico.
Altezza: 14,5 cm - Interasse: 15,5 cm
One hole bidet mixer with "Antique" spout and pop-up waste.
Height: 14,5 cm - Interaxis: 15,5 cm.



RT6302
Batteria bidet con scarico.
Altezza: 8,5 cm - Interasse: 10 cm
Three holes bidet set with pop-up waste.
Height: 8,5 cm - Interaxis: 10 cm.

MISS

DEKORA

TIME



RT6030
Combinazione bidet con scarico.
Bidet supply fitting with pop-up waste.



RT6004
Batteria bidet con canna antica e scarico.
Altezza: 18 cm - Interasse: 11,5 cm
Bidet set with "Antique" spout and pop-up waste.
Height: 18 cm - Interaxis: 11,5 cm.

TICINO

MISCELATORI VASCA E DOCCIA - SHOWER AND BATH MIXERS



RT4102
Gruppo vasca esterno con kit doccia, doccia e flessibile 120 cm.
Bathtub mixer with shower kit and flexible 120 cm



RT4102UK
Gruppo vasca esterno su colonnette alte con flessibile cm 120 e doccia normale.
Bathtub mixer on high studs with flexible cm 120 and normal shower.

RETRÓ

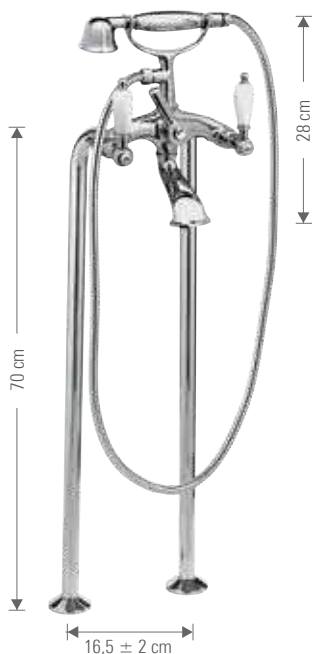

RT4102XL
Gruppo vasca esterno su colonne da pavimento, con doccia.
Traditional bathtub mixer, on floor columns, with shower.



Gruppo doccia esterno.
Wall-mounted shower mixer.

RT4433A con kit doccia.
with shower kit.

RT4433 senza kit doccia.
without shower kit.



RT4192
Batteria bordo vasca con doccia estraibile.
Bathtub set with pull-out shower.



RT4100Z
Gruppo vasca con deviatore e attacco 3/4M.
Bathtub mixer with diverter and 3/4M connection.



RT4433Z
Gruppo doccia esterno attacco 3/4 per colonna doccia.
Wall-mounted shower mixer connection 3/4 for columns.

BOX INCASSO - BUILT-IN BOX

RT602KB

Set miscelatore doccia da abbinare al box incasso.
Shower mixer set to match with the built-in box.



DAN BOX

Box da incasso per miscelatore doccia con deviatore.
Built-in box for shower mixer with diverter.

RT612KB

Set miscelatore doccia con deviatore da abbinare al box incasso.
Shower mixer set with diverter to match with the built-in box.



DAN BOX

Box da incasso per miscelatore doccia con deviatore.
Built-in box for shower mixer with diverter.

INCASSI DOCCIA - BUILT-IN MIXERS



RT602
Miscelatore monocomando doccia incasso.
Single lever built-in shower mixer.



RT612
Miscelatore monocomando vasca/doccia incasso con deviatore.
Single lever built-in bath/shower mixer with diverter.

CRYSTAL

CRYSTAL
RETRO

COLONNE DOCCIA E VASCA - SHOWER AND BATH COLUMN

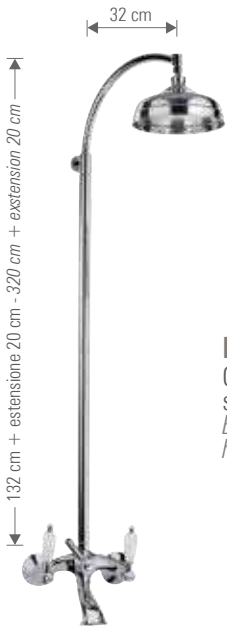

RT413789
Gruppo vasca con colonna girevole e soffione tutto in ottone cromato.
Bathtub mixer with column and shower head all in brass.



RT413689
Gruppo vasca con colonna saliscendi girevole e deviatore con doccia, flessibile e soffione tutto in ottone cromato.
Bathtub mixer with sliding rail column and diverter with shower, flexible and shower head all in brass.

REVIVAL
DEKORA
SENSE

RETRO

LIFE
DEKORA

MISS
DEKORA

TIME



RT443789
Gruppo doccia con colonna girevole e soffione tutto in ottone cromato.
Shower mixer with swivelling column and shower head all in C.P. brass.



RT443689
Gruppo doccia con colonna saliscendi girevole e deviatore con doccia, flessibile e soffione tutto in ottone cromato.
Shower mixer with sliding rail column and diverter with shower, flexible and shower head. All in C.P. brass.

TICINO

CUCINA - KITCHEN



RT7007

Gruppo lavello a muro con canna antica.
Altezza: 21,5 cm - Interasse: 23,5 cm
Wall-mounted sink set with "Antique" spout.
Height: 21,5 cm - Interaxis: 23,5 cm.



RT7114

Monoforo lavello con canna antica.
Altezza: 24 cm - Interasse: 23,5 cm
One hole sink mixer with "Antique" spout.
Height: 24 cm - Interaxis: 23,5 cm.



RT618

Miscelatore monocomando cucina con canna antica.
Altezza: 28 cm - Interasse: 23,5 cm
Single lever kitchen mixer with "Antique" spout.
Height: 28 cm - Interaxis: 23,5 cm.



RT7250A

Rubinetto a colonnina.
Altezza: 28 cm - Interasse: 23,5 cm
Bar faucet.
Height: 28 cm - Interaxis: 23,5 cm.



RT9200

Maniglia Retrò.
Retrò handle.



CLASSICA
CLASSIC

CRYSTAL

CRYSTAL
RETRO

REVIVAL

DEKORA
SENSE

RETRO

LIFE

DEKORA

MISS

DEKORA

TIME

TICINO



LIFE

LIFE è una collezione di rubinetteria tradizionale, caratterizzata da un disegno sobrio e da un'architettura pulita. Un'eleganza senza tempo in cui la distanza tra passato e presente si annulla, lasciando spazio al solo piacere di vivere l'ambiente bagno con semplicità.

LIFE is a traditional faucets collection, characterized by a sober design and clean architecture. Timeless elegance where the distance between past and present vanishes, leaving space only for the pleasure of living the bathroom with ease.

FINISHINGS

FIN 1											
 11CR bianco raal/cromo white raal/chrome	 CRDO cromo/oro chrome/gold	 11OT bianco raal/ottone white raal/brass	 01 bianco lucido shiny white	 07 nero lucido shiny black	 11 bianco raal white raal	 11DO bianco raal/oro white raal/gold	 07DO nero lucido/oro shiny black/gold	 07CR nero lucido/cromo shiny black/chrome			
FIN 2											
 NPO nichel spazzolato opaco matt brushed nickel	 64 vecchio rame old copper	 OIL oil bronze oil bronze	 CP cromo spazzolato brushed chrome	 NP nichel spazzolato brushed nickel	 63 vecchio ottone old brass	 SM ottone s. marco s. marco brass	 OT ottone lucido shiny brass	 15CR nero opaco/cromo matt black/chrome	 OP ottone spazzolato brushed brass	 14 bianco opaco matt white	 15 nero opaco matt black
 OM v. ottone opaco matt old brass	 NPCR nichel spazz./cromo brushed nickel/chrome										
FIN 4											
 FZ cromo nero spazzolato lucido shiny brushed black chrome	 CF cromo nero lucido shiny black chrome	 GO grafite graphite	 DO oro lucido shiny gold	 DP oro spazzolato brushed gold	 RL rame lucido shiny copper	 88 oro antico old gold	 EG oro inglese english gold	 CFDO cromo nero lucido/ oro lucido shiny black chrome/ shiny gold			
FIN 5											
 PG oro rosa lucido shiny pink gold	 PP oro rosa spazzolato brushed pink gold	 RPO rame anodizzato anodised copper									

Finiture consigliate per questa collezione.
Per l'elenco completo fare riferimento alla tabella delle finiture (pag.04)

*Suggested finishes for this collection.
For a complete list of available colors, please refer to the finishing table (page 04)*



CRYSTAL

CRYSTAL
RETRO

REVIVAL
DEKORA
SENSE

RETRO

LIFE
DEKORA

MISS
DEKORA

TIME

TICINO



DECORI DISPONIBILI:
AVAILABLE DECORATIONS: DAMASCO YF



DECO 2



YF97 nichel spazzolato, decoro nichel lucido.
brushed nickel, shiny nickel decoration.

DECO 4



YF87 nichel spazzolato, decoro oro lucido.
brushed nickel, shiny gold decoration



YF95 canna di fucile spazzolato, decoro cromo.
brushed gun barrel, chrome decoration.



YF98 ottone spazzolato, decoro ottone lucido
brushed brass, shiny brass decoration

DECO 5



YF83 oro lucido, decoro nichel spazzolato.
shiny gold, brushed nickel decoration.



YF88 oro antico, decoro canna di fucile spazzolato.
antique gold, brushed gun barrel decoration.



YF94 canna di fucile spazzolato, decoro oro spazzolato
brushed gun barrel, brushed gold decoration



YF96 oro spazzolato, decoro cromo.
brushed gold, chrome decoration.

CARATTERISTICHE TECNICHE:

La serie è dotata di vitone ceramico,
prodotto da S.T.S.R. Studio Tecnico Sviluppo e Ricerche
www.stsr.it

TECHNICAL CHARACTERISTICS:

The series is equipped with ceramic headvalves,
produced by S.T.S.R. - Research Development Technical Office
www.stsr.it

LAVABI E BIDET - WASHBASIN AND BIDET MIXERS

**L5112NPCR**

Monoforo lavabo con scarico.
Altezza: 15 cm - Interasse: 12,5 cm.
One hole washbasin mixer with pop-up waste.
Height: 15 cm - Interaxis: 12,5 cm.

**L5116NPCR**

Monoforo lavabo con canna tubo e scarico.
Altezza: 28,5 cm - Interasse: 19 cm.
One hole washbasin mixer with tube spout and pop-up waste.
Height: 28,5 cm - Interaxis: 19 cm.

**L5003NPCR**

Batteria lavabo con scarico.
Altezza: 16 cm - Interasse: 12,5 cm.
Washbasin set with pop-up waste.
Height: 16 cm - Interaxis: 12,5 cm.

**L6200NPCR**

Monoforo bidet con scarico.
Altezza bocca: 7 cm - Interasse: 10 cm.
One hole bidet mixer with pop-up waste.
Height spout: 7 cm - Interaxis: 10 cm.

**L6302NPCR**

Batteria bidet con scarico.
Altezza bocca: 5,5 cm - Interasse: 10 cm.
Three holes bidet set with pop-up waste.
Height spout: 5,5 cm - Interaxis: 10 cm.

**L6300NPCR**

Batteria bidet con scarico e doccia.
Bidet set with pop-up waste and shower.

**L6030NPCR**

Combinazione bidet con scarico.
Bidet supply fitting with pop-up waste.

ACCESSORI - ACCESSORIES



L9200NPCR
Maniglia Life.
Life handle.



L4454NPCR
Rubinetto doccia incasso 1/2.
Built-in right valve 1/2.



L4704NPCR
Bocca incasso.
Built-in spout.

CRYSTAL

CRYSTAL
RETRO

REVIVAL

DEKORA
SENSE

RETRO

MISCELATORI VASCA E DOCCIA - SHOWER AND BATH MIXERS



Gruppo vasca esterno.
Bathtub mixer.

L4302NPCR con kit doccia e flessibile 150 cm.
with shower kit and flexible 150 cm.

L4300NPCR con kit doccia e flessibile 120 cm.
with shower kit and flexible 120 cm

L4300HNPCR senza kit doccia.
without shower kit.



L4491NPCR
Batteria bordo vasca con doccia estraibile in ottone cromato.
Bathtub set with pull-out shower in c.p. brass..

LIFE
DEKORA

MISS
DEKORA

TIME

TICINO



L4440NPCR
Batteria vasca incasso con set doccia.
Built-in bathtub mixer with shower kit.



Gruppo doccia esterno
Wall-mounted shower mixer.

L4433ANPCR con kit doccia.
with shower kit.

L4433NPCR senza kit doccia.
without shower kit.

COLONNE DOCCIA E VASCA - SHOWER AND BATH COLUMN

**L4437NPCR**

Gruppo vasca con colonna girevole e soffione tutto in ottone cromato.
Bathtub mixer with column and shower head all in brass.

**L4436NPCR**

Gruppo vasca con colonna saliscendi girevole con deviatore doccia, flessibile e soffione.
Bathtub mixer with sliding rail column with diverter shower, flexible and shower head.

CUCINA - KITCHEN

**L7004NPCR**

Gruppo lavello a muro con canna fusa a "S".
 Interasse: 19 cm
Wall-mounted sink set with "S" casted spout.
 Interaxis: 19 cm.

**L7100NPCR**

Monoforo lavello con bocca girevole.
 Altezza: 28,5 cm - Interasse: 21,5 cm
One hole sink mixer with swiveling spout.
 Height: 28,5 cm - Interaxis: 21,5 cm.

**L7005NPCR**

Gruppo lavello a muro con canna fusa alta.
 Altezza: 25 cm - Interasse: 20,5 cm
Wall-mounted sink set with high casted spout.
 Height: 25 cm - Interaxis: 20,5 cm.



CRYSTAL

CRYSTAL
RETRO

REVIVAL

DEKORA
SENSE

RETRO

LIFE

DEKORA

MISS

DEKORA

TIME

TICINO



MISS

La Collezione MISS raccoglie tutta l'eleganza delle forme più classiche e la ripropone in una rubinetteria delle finiture preziose e dai dettagli ricercati.

MISS collection gathers all the elegance of more traditional shapes and re-proposes it in taps with precious finishes and elegant details.

FINISHINGS

FIN 1					
11CR bianco raal/cromo white raal/chrome	CRDO cromo/oro chrome/gold	110T bianco raal/ottone white raal/brass	01 bianco lucido shiny white	07 nero lucido shiny black	11 bianco raal white raal
11DO bianco raal/oro white raal/gold	07DO nero lucido/oro shiny black/gold	07CR nero lucido/cromo shiny black/chrome			
FIN 2					
NPO nichel spazzolato opaco matt brushed nickel	64 vecchio rame old copper	OIL oil bronze oil bronze	CP cromo spazzolato brushed chrome	NP nichel spazzolato brushed nickel	63 vecchio ottone old brass
SM ottone s. marco s. marco brass	OT ottone lucido shiny brass	15CR nero opaco/cromo matt black/chrome	OP ottone spazzolato brushed brass	14 bianco opaco matt white	15 nero opaco matt black
OM v. ottone opaco matt old brass	NPCR nichel spazz./cromo brushed nickel/chrome				
FIN 4					
FZ cromo nero spazzolato lucido shiny brushed black chrome	CF cromo nero lucido shiny black chrome	GO grafite graphite	DO oro lucido shiny gold	DP oro spazzolato brushed gold	RL rame lucido shiny copper
88 oro anticato old gold	EG oro inglese english gold	CFDO cromo nero lucido/ oro lucido shiny black chrome/ shiny gold			
FIN 5					
PG oro rosa lucido shiny pink gold	PP oro rosa spazzolato brushed pink gold	RPO rame anodizzato anodised copper			

Finiture consigliate per questa collezione.
Per l'elenco completo fare riferimento alla tabella delle finiture (pag.04)

*Suggested finishes for this collection.
For a complete list of available colors, please refer to the finishing table (page 04)*



CRYSTAL

CRYSTAL
RETRO

REVIVAL
DEKORA
SENSE

RETRO

LIFE
DEKORA

MISS
DEKORA

TIME

TICINO



DECORI DISPONIBILI:
AVAILABLE DECORATIONS: DAMASCO YF



DECO 2

YF86 nichel spazzolato, decoro canna di fucile spazzolato.
brushed nickel, brushed gun barrel decoration.

YF97 nichel spazzolato, decoro nichel lucido.
brushed nickel, shiny nickel decoration.

DECO 3

YF89 ottone scuro, decoro ottone lucido.
dark brass, shiny brass decoration

DECO 4

YF87 nichel spazzolato, decoro oro lucido.
brushed nickel, shiny gold decoration

YF95 canna di fucile spazzolato, decoro cromo.
brushed gun barrel, chrome decoration.

YF98 ottone spazzolato, decoro ottone lucido
brushed brass, shiny brass decoration

DECO 5

YF83 oro lucido, decoro nichel spazzolato.
shiny gold, brushed nickel decoration.

YF88 oro antico, decoro canna di fucile spazzolato.
antique gold, brushed gun barrel decoration.

YF94 canna di fucile spazzolato, decoro oro spazzolato
brushed gun barrel, brushed gold decoration

YF96 oro spazzolato, decoro cromo.
brushed gold, chrome decoration.

CARATTERISTICHE TECNICHE:

La serie è dotata di vitone ceramico,
prodotto da S.T.S.R. Studio Tecnico Sviluppo e Ricerche
www.stsr.it

TECHNICAL CHARACTERISTICS:

The series is equipped with ceramic headvalves,
produced by S.T.S.R. - Research Development Technical Office
www.stsr.it

LAVABI E BIDET - WASHBASIN AND BIDET MIXERS



MI5112

Monoforo lavabo con scarico.
Altezza: 15 cm - Interasse: 12,5 cm.
One hole washbasin mixer with pop-up waste.
Height: 15 cm - Interaxis: 12,5 cm.



MI5112L

Monoforo lavabo con scarico click-clack.
Altezza: 17,5 cm - Interasse: 13 cm.
One hole washbasin mixer with click-clack waste.
Height: 17,5 cm - Interaxis: 13 cm.



MI5116

Monoforo lavabo con canna tubo e scarico.
Altezza: 38 cm - Interasse: 18,5 cm.
One hole washbasin mixer with tube spout and pop-up waste.
Height: 38 cm - Interaxis: 18,5 cm.



MI5003

Batteria lavabo con scarico.
Altezza: 15 cm - Interasse: 13 cm.
Washbasin set with pop-up waste.
Height: 15 cm - Interaxis: 13 cm.



MI6200

Monoforo bidet con scarico.
Altezza bocca: 7 cm - Interasse: 10 cm.
One hole bidet mixer with pop-up waste.
Height spout: 7 cm - Interaxis: 10 cm.



MI6302

Batteria bidet con scarico.
Altezza bocca: 5,5 cm - Interasse: 10 cm.
Three holes bidet set with pop-up waste.
Height spout: 5,5 cm - Interaxis: 10 cm.



MI6300

Batteria bidet con scarico e doccia.
Bidet set with pop-up waste and shower.



MI6030

Combinazione bidet con scarico.
Bidet supply fitting with pop-up waste.

MISCELATORI VASCA E DOCCIA - SHOWER AND BATH MIXERS



Gruppo vasca esterno.
Bathtub mixer.

MI4302 con kit doccia, doccia duplex e flessibile 150 cm.
with duplex shower kit and flexible 150 cm.

MI4300 con kit doccia, doccia duplex e flessibile 120 cm.
with duplex shower kit and flexible 120 cm.

MI4300H senza kit doccia.
without shower kit.



MI4492
Miscelatore bordo vasca
quattro fori.
Deck bath set with diverter.



MI4491
Batteria bordo vasca con
doccia estraibile.
*Bathtub set with pull-out
shower.*



MI4441
Batteria vasca incasso con
deviatore, presa acqua con
flessibile cm 150 e doccetta ad
1 funzione e braccio doccia con
soffione. Tutto in ottone cromato.
*Built-in bathtub mixer with
diverter, water punch/shower
holder with flexible cm 150
and 1 function handshower,
shower arm with shower head.
All in C.P. brass.*



MI4440
Batteria vasca incasso con
deviatore completa di set doccia
e bocca a incasso.
*Built-in bathtub mixer with
diverter complete of shower kit
and built-in spout.*

CRYSTAL

CRYSTAL
RETRO

REVIVAL

DEKORA
SENSE

RETRO

LIFE

DEKORA

MISS

DEKORA

TIME

TICINO



MISS



Gruppo doccia esterno.
Wall-mounted shower mixer.

MI4433A

con kit doccia.
with shower kit.

MI4433

senza kit doccia.
without shower kit.



MI4433Z

Gruppo doccia esterno, attacco 3/4 per
colonna doccia.
*Wall mounted shower mixer with connection
3/4 for columns.*

COLONNE DOCCIA - SHOWER COLUMN



MI4437

Gruppo doccia con colonna girevole e
soffione tutto in ottone cromato.
*Shower mixer with column and shower head
all in brass.*



MI4436

Gruppo doccia con colonna saliscendi
girevole con deviatore doccetta, flessibile e
soffione.
*Shower mixer with sliding rail column with
diverter shower, flexible and shower head.*

ACCESSORI - ACCESSORIES



MI4454

Rubinetto doccia incasso 1/2.
Built-in right valve 1/2.



L4704

Bocca incasso.
Built-in spout.



MI9200

Maniglia Miss.
Miss handle.

CUCINA - KITCHEN



MI7005

Gruppo lavello a muro con canna fusa alta.
Altezza: 25 cm - Interasse: 20,5 cm
Wall-mounted sink set with high casted spout.
Height: 25 cm - Interaxis: 20,5 cm.



MI7004

Gruppo lavello a muro con canna fusa a "S".
Lunghezza canna: 19 cm
Wall-mounted sink set with "S" casted spout.
Lenght spout: 19 cm.



MI7100

Monoforo lavello con bocca girevole.
Altezza: 28 cm - Interasse: 19 cm
One hole sink mixer with swiveling spout.
Height: 28 cm - Interaxis: 19 cm.



CRYSTAL

CRYSTAL
RETRO

REVIVAL

DEKORA
SENSE

RETRO

LIFE
DEKORA

MISS
DEKORA

TIME

TICINO



TIME

CARATTERISTICHE TECNICHE:
 La serie è dotata di vitone ceramico,
 prodotto da S.T.S.R. Studio Tecnico Sviluppo e Ricerche
www.stsr.it

TECHNICAL CHARACTERISTICS:
 The series is equipped with ceramic headvalves,
 produced by S.T.S.R. - Research Development Technical Office
www.stsr.it

FINISHINGS

FIN 1					
11CR bianco raal/cromo white raal/chrome	CRDO cromo/oro chrome/gold	110T bianco raal/ottone white raal/brass	01 bianco lucido shiny white	07 nero lucido shiny black	11 bianco raal white raal
11DO bianco raal/oro white raal/gold	07DO nero lucido/oro shiny black/gold	07CR nero lucido/cromo shiny black/chrome			
FIN 2					
NPO nichel spazzolato opaco matt brushed nickel	64 vecchio rame old copper	OIL oil bronze oil bronze	CP cromo spazzolato brushed chrome	NP nichel spazzolato brushed nickel	63 vecchio ottone old brass
SM ottone s. marco s. marco brass	OT ottone lucido shiny brass	15CR nero opaco/cromo matt black/chrome	OP ottone spazzolato brushed brass	14 bianco opaco matt white	15 nero opaco matt black
OM v. ottone opaco matt old brass	NPCR nichel spazz./cromo brushed nickel/chrome				
FIN 4					
FZ cromo nero spazzolato lucido shiny brushed black chrome	CF cromo nero lucido shiny black chrome	GO grafite graphite	DO oro lucido shiny gold	DP oro spazzolato brushed gold	RL rame lucido shiny copper
88 oro anticato old gold	EG oro inglese english gold	CFDO cromo nero lucido/ oro lucido shiny black chrome/ shiny gold			
FIN 5					
PG oro rosa lucido shiny pink gold	PP oro rosa spazzolato brushed pink gold	RPO rame anodizzato anodised copper			

Finiture consigliate per questa collezione.
 Per l'elenco completo fare riferimento alla tabella delle finiture (pag.04)

*Suggested finishes for this collection.
 For a complete list of available colors, please refer to the finishing table (page 04)*



CLASSICA
CLASSIC

CRYSTAL

CRYSTAL
RETRO

REVIVAL
DEKORA
SENSE

RETRO

LIFE
DEKORA

MISS
DEKORA

TIME



TICINO

LAVABI E BIDET - WASHBASIN AND BIDET MIXERS



T5112

Monoforo lavabo con scarico.
Altezza: 15 cm - Interasse: 12,5 cm.
One hole washbasin mixer with pop-up waste.
Height: 15 cm - Interaxis: 12,5 cm.



T5003

Batteria lavabo con scarico.
Altezza: 16 cm - Interasse: 12,5 cm.
Washbasin set with pop-up waste.
Height: 16 cm - Interaxis: 12,5 cm.



T5116

Monoforo lavabo con canna tubo e scarico.
Altezza: 31 cm - Interasse: 19 cm.
One hole washbasin mixer with tube spout and pop-up waste.
Height: 31 cm - Interaxis: 19 cm.



T6200

Monoforo bidet con scarico.
Altezza bocca: 7 cm - Interasse: 10 cm.
One hole bidet mixer with pop-up waste.
Height spout: 7 cm - Interaxis: 10 cm.



T6302

Batteria bidet con scarico.
Altezza bocca: 5,5 cm - Interasse: 10 cm.
Three holes bidet set with pop-up waste.
Height spout: 5,5 cm - Interaxis: 10 cm.



T6300

Batteria bidet con scarico e doccia.
Bidet set with pop-up waste and shower.



T6030

Combinazione bidet con scarico.
Bidet supply fitting with pop-up waste.

MISCELATORI VASCA E DOCCIA - SHOWER AND BATH MIXERS



Gruppo vasca esterno.
Bathtub mixer.

T4302

con kit doccia, doccia duplex e flessibile 150 cm.
with duplex shower kit and flexible 150 cm.

T4300

con kit doccia, doccia duplex e flessibile 120 cm.
with duplex shower kit and flexible 120 cm.

T4300H

senza kit doccia.
without shower kit.



Miscelatore lavabo/vasca con canna "S" cm 30.
Exposed basin/bath mixer with "S" spout cm 30.

T7623S

con deviatore con doccia duplex.
with diverter and duplex shower.

T7623SH

senza kit doccia.
without shower kit.



T4440
Batteria vasca incasso con set doccia.
Built-in bathtub mixer with shower kit.



T4491
Batteria bordo vasca con doccia estraibile.
Bathtub set with pull-out shower.



Miscelatore lavabo/vasca con canna fusa cm 30.
Exposed basin/bath mixer with casted spout cm 30.

T7624 con deviatore con doccia duplex.
with diverter and duplex shower.

T7624H senza kit doccia.
without shower kit.



Gruppo doccia esterno.
Wall-mounted shower mixer.

T4433A con kit doccia.
with shower kit.

T4433 senza kit doccia.
without shower kit.

CRYSTAL

CRYSTAL
RETRO

REVIVAL
DEKORA
SENSE

RETRO

LIFE
DEKORA

MISS
DEKORA

TIME

TICINO

ACCESSORI - ACCESSORIES



L4704
Bocca incasso.
Built-in spout.



T4454
Rubinetto doccia incasso 1/2.
Built-in right valve 1/2.

CUCINA - KITCHEN



T7100
Monoforo lavello con bocca girevole.
Altezza: 28,5 cm - Interasse: 21,5 cm
One hole sink mixer with swiveling spout.
Height: 28,5 cm - Interaxis: 21,5 cm.



T7005
Gruppo lavello a muro con canna fusa alta.
Altezza: 25 cm - Interasse: 20,5 cm
Wall-mounted sink set with high casted spout.
Height: 25 cm - Interaxis: 20,5 cm.



T7004
Gruppo lavello a muro con canna fusa a "S".
Lunghezza canna: 19 cm
Wall-mounted sink set with "S" casted spout.
Length spout: 19 cm.



T9200
Maniglia Time.
Time handle.



TICINO

CARATTERISTICHE TECNICHE:
 La serie è dotata di vitoni standard,
 prodotto da S.T.S.R. Studio Tecnico Sviluppo e Ricerche
www.stsr.it

TECHNICAL CHARACTERISTICS:
 The series is equipped with standard headvalves,
 produced by S.T.S.R. - Research Development Technical Office
www.stsr.it



R
Tris



C
Ticino



O
Orta



F
Trifoglio



VE
Vera



A
Anastasia



Z
Zara



CLASSICA
CLASSIC

CRYSTAL

CRYSTAL
RETRO

REVIVAL

DEKORA
SENSE

RETRO

LIFE

DEKORA

MISS

DEKORA

TIME



TICINO

LAVABI E BIDET - WASHBASIN AND BIDET MIXERS



Batteria lavabo.
Altezza: 10 cm - Interasse: 10 cm.
Washbasin set.
Height: 10 cm - Interaxis: 10 cm.

C5003

con scarico.
with pop-up waste.

C5002

senza scarico.
without waste.



Monoforo lavabo.
Altezza: 13 cm - Interasse: 10 cm.
One hole washbasin mixer.
Height: 13 cm - Interaxis: 10 m.

C5112

con scarico.
with pop-up waste.

C5110

senza scarico.
without waste.



C5118
Monoforo lavabo con canna fusa e scarico.
Altezza: 21 cm - Interasse: 13 cm.
One hole washbasin mixer with casted spout and pop-up waste.
Height: 21 cm - Interaxis: 13 cm.



C5113
Gruppo lavabo a ponte con canna Ø 18 mm.
Altezza: 28 cm - Interasse: 14,5 cm.
Wash basin mixer bridge type with spout Ø 18 mm.
Height: 28 cm - Interaxis: 14,5 cm.



C5116
Monoforo lavabo con canna tubo e scarico.
Altezza: 27 cm - Interasse: 17 cm.
One hole washbasin mixer with tube spout and pop-up waste.
Height: 27 cm - Interaxis: 17 cm.



Monoforo bidet.
One hole bidet mixer.

C6200

con scarico.
with pop-up waste.

C6210

senza scarico.
without waste.



C6302
Batteria bidet con scarico.
Three holes bidet set with pop-up waste.



C6030
Combinazione bidet con scarico.
Bidet supply fitting with pop-up waste.



C6080
Combinazione bidet senza scarico.
Bidet supply fitting without waste.



C6300
Batteria bidet con scarico e doccia.
Bidet set with pop-up waste and shower.

ACCESSORI - ACCESSORIES



C9200
Maniglia Ticino.
Ticino handle.



C4454
Rubinetto doccia incasso 1/2.
Built-in right valve 1/2.

COLONNE VASCA/DOCCIA - BATH/SHOWER COLUMN



C4305AS

Colonna doccia e soffione doccia standard.
Standpipe and standard showerhead.



C4305

Gruppo vasca con colonna doccia e soffione standard.
Bathtub mixer with standpipe and standard showerhead.

CRYSTAL

CRYSTAL
RETRO

REVIVAL

DEKORA
SENSE

RETRO

LIFE

DEKORA

MISS

DEKORA

TIME

MISCELATORI VASCA E DOCCIA - SHOWER AND BATH MIXERS



Gruppo vasca esterno.
Bathtub mixer.

C4302

con kit doccia duplex e flessibile 150 cm.
with duplex shower kit and flexible 150 cm.

C4300

con kit doccia duplex e flessibile 120 cm.
with duplex shower kit and flexible 120 cm.

C4300H

senza kit doccia.
without shower kit.



Gruppo vasca esterno.
Bathtub mixer.

C4304

con doccia duplex e deviatore manuale.
with duplex shower and manual diverter.

C4300Z

con attacco colonna e deviatore manuale, senza kit doccia.
with column connection and manual diverter without shower kit.



C4306

Gruppo vasca esterno con doccia duplex e canna lunga girevole.
Lunghezza canna: 40 cm.
Bathtub mixer with duplex shower and long movable spout. Length spout: 40 cm.



C4440

Batteria vasca incasso con set doccia.
Built-in bathtub mixer with shower kit.

TICINO

TICINO



Miscelatore lavabo/vasca con canna "S".
Lunghezza canna: 30 cm.
*Exposed basin/bath mixer with "S" spout.
Lenght spout: 30 cm.*

C7623S

con deviatore con doccia duplex.
with diverter and duplex shower.

C7623SH

con deviatore, senza kit doccia.
with diverter, without shower kit.



Gruppo doccia esterno.
Wall-mounted shower mixer.

C4433A

con kit doccia.
with shower kit.

C4433

senza kit doccia.
without shower kit.

CUCINA - KITCHEN



C7004

Gruppo lavello a muro con canna tubo bassa.
Altezza: 18 cm - Lunghezza canna: 18 cm.
*Wall-mounted sink set with lower tube spout.
Height: 18 cm - Lenght spout: 18 cm.*



C7000

Gruppo lavello a muro con canna a "U".
Lunghezza canna: 18 cm.
*Wall-mounted sink set with "U" spout.
Lenght spout: 18 cm.*



C7017

Gruppo lavello a muro con attacco lavatrice e canna a "S" bassa.
Lunghezza canna: 18 cm.
*Wall-mounted sink set for washing machine with lower spout.
Lenght spout: 18 cm.*



C7005

Gruppo lavello a muro con canna tubo alta.
Interasse: 17 cm.
*Wall-mounted sink set with upper tube spout.
Lenght spout: 17 cm.*



C7112

Monoforo lavello con bocca fusa girevole.
Altezza: 24 cm - Interasse: 19 cm.
*One hole sink mixer with swiveling casted spout.
Height: 24 cm - Interaxis: 19 cm.*



C7100

Monoforo lavello con bocca girevole.
Altezza: 27 cm - Interasse: 17 cm.
*One hole sink mixer with swiveling spout.
Height: 27 cm - Interaxis: 17 cm.*



C7100A

Monoforo lavello tipo economico con bocca girevole.
Altezza: 26,5 cm - Interasse: 17 cm.
*One hole sink mixer, economic type with swiveling spout.
Height: 26,5 cm - Interaxis: 17 cm.*

RUBINETTI MONOACQUA - SINGLE WATER TAPS

CRYSTAL

CRYSTAL
RETRO

REVIVAL

DEKORA
SENSE

RETRO

LIFE

DEKORA

MISS

DEKORA

TIME

TICINO



C5009
Rubinetto collo cigno 1/2.
Wash-basin tap 1/2.



C7202
Rubinetto a muro con canna bassa.
Sink tap with lower spout.



C7250
Rubinetto a colonnina.
Bar faucet.



C7200J
Rubinetto a muro con canna alta a "J".
Sink tap with high "J" swiveling spout.



C7200U
Rubinetto a snodo pesante, 1/2 con canna alta a "U" Ø 18 mm girevole, con rompigetto.
Sink tap 1/2, with high "U" swiveling spout Ø 18 mm, and aerator.



C7200
Rubinetto a squadra per lavatrice, 1/2x3/4.
Angle tap for washing machine 1/2x3/4.



C720012
Rubinetto a squadra per lavatrice, 1/2x1/2.
Angle tap for washing machine 1/2x1/2.



C7222
Rubinetto prolungato.
Extended tap.



C7230
Rubinetto con portagomma.
Bibtap with hose union.



C7215
Rubinetto a 2 maniglie per attacco lavatrice 1/2x3/4.
Washing machine bibcock 1/2x3/4.



C7210
Rubinetto a snodo con attacco lavatrice, 1/2.
Washing machine bibcock, with swiveling spout 1/2.



C7212
Rubinetto curvo con uscita da 1/2" e uscita da bocca di erogazione, attacco 1/2" M.
Angle tap with 1/2" output and spout output, 1/2" M connection.



VENUS

CARATTERISTICHE TECNICHE:
 La serie è dotata di cartuccia Ø40,
 prodotta da S.T.S.R. Studio Tecnico Sviluppo e
 Ricerche
www.stsr.it

TECHNICAL CHARACTERISTICS:
 The series is equipped with cartridge Ø40,
 produced by S.T.S.R. - Research Development
 Technical Office
www.stsr.it

MANIGLIE DISPONIBILI:
 AVAILABLE HANDLES:



Maniglia VA
 VA Lever



Maniglia VE
 VE Lever

LAVABI E BIDET - WASHBASIN AND BIDET MIXERS



Monocomando lavabo.
 Altezza: 14 cm - Interasse: 10 cm.
Single-lever basin mixer.
Height: 14 cm - Interaxis: 10 cm.

VE13605

con scarico.
with pop-up waste.

VE13606

senza scarico.
without waste.



Miscelatore bidet con scarico.
 Altezza: 14 cm - Interasse: 10 cm.
Bidet mixer with pop-up waste.
Height: 14 cm - Interaxis: 10 cm.

VE13604

con scarico.
with pop-up waste.

VE13607

senza scarico.
without waste.



VE13606G

Miscelatore lavabo/lavello con bocca girevole.
 Altezza: 10 cm - Interasse: 14,5 cm.
Single-lever one-hole basin or sink mixer,
with movable spout.
Height: 10 cm - Interaxis: 14,5 cm.

MISCELATORI VASCA E DOCCIA - BATH & SHOWER MIXERS

VENUS



Miscelatore vasca esterno.
Exposed bath/shower mixer.

VE13610 con flessibile cm 150 e doccetta.
with flexible cm 150 and handshower.

VE13600 con flessibile cm 120 e doccetta.
with flexible cm 120 and handshower.

VE13600H senza kit doccia.
without shower kit.



Miscelatore monocomando
vasca con deviatore.
*Bathtub single-lever mixer with
diverter.*

VE13606D con flessibile cm 150 e doccetta.
with flexible cm 150 and handshower.

VE13606DH senza kit doccia.
without shower kit.

RIO

SERENA

CONTRACT

ECO



VE13691
Miscelatore bordo vasca con
doccia estraibile.
Bathtub set with pull-out shower.



VE13698
Batteria bordo vasca con bocca
a cascata e doccia estraibile.
*Bathtub set with pull-out shower
and waterfall spout.*

LEVA
CLINICA

MINI



Miscelatore lavabo/vasca con
canna fusa con deviatore.
Lunghezza canna: 30 cm.
*Exposed basin/bath mixer with
casted spout cm 30 with diverter.
Lenght spout: 30 cm.*

VE13624 con flessibile e doccetta.
with flexible and handshower.

VE13624H senza kit doccia.
without shower kit.



Miscelatore lavabo/vasca con
canna "S" con deviatore.
Lunghezza canna: 30 cm.
*Exposed basin/bath mixer with
"S" spout with diverter.
Lenght spout: 30 cm.*

VE13623S con flessibile e doccetta.
with flexible and handshower.

VE13623SH senza kit doccia.
without shower kit.

MINI
100

Miscelatore doccia esterno.
Exposed shower mixer.

VE13611A con flessibile e doccetta.
with flexible and handshower.

VE13611 senza kit doccia.
without shower kit.



Miscelatore doccia esterno con
leva frontale.
*Exposed shower mixer with
frontal lever.*

VE13631A con flessibile e doccetta.
with flexible and handshower.

VE13631 senza kit doccia.
without shower kit.

INCASSI DOCCIA - BUILT IN SHOWER MIXER



VE13602
Miscelatore doccia incasso.
Built-in shower mixer.



VE13612
Miscelatore vasca incasso con deviatore.
Built-in bath/shower mixer with diverter.

BOX INCASSO - BUILT-IN BOX

VE13602KB

Set miscelatore doccia da abbinare al box incasso.
Shower mixer set to match with the built-in box.



DAN BOX

Box da incasso per miscelatore doccia con deviatore.
Built-in box for shower mixer with diverter.

VE13612KB

Set miscelatore doccia con deviatore da abbinare al box incasso.
Shower mixer set with diverter to match with the built-in box.



DAN BOX

Box da incasso per miscelatore doccia con deviatore.
Built-in box for shower mixer with diverter.

BOCCE ED ACCESSORI - SPOUTS AND ACCESSORIES



4704
Bocca incasso 15 cm.
Built-in spout 15 cm.



4702
Bocca incasso vasca-doccia, con deviatore integrato 15 cm.
Built-in spout for bath-shower, with integrated diverter 15 cm.



VE7630
Maniglia Venus.
Venus lever.

CUCINA - KITCHEN



VE13617
Miscelatore lavello monoforo 45° con canna alta "U" girevole.
Altezza: 27 cm - Interasse: 22 cm.
Single-lever sink mixer 45° with high movable "U" spout.
Height: 27 cm - Interaxis: 22 cm.



VE13614R
Miscelatore monocomando per lavello, con bocca alta girevole, tipo lusso.
Altezza: 29 cm - Interasse: 19,5 cm.
Single-lever one-hole sink mixer, with high movable spout, luxury type.
Height: 29 cm - Interaxis: 19,5 cm.

**VE13614T**

Miscelatore lavello monoforo 45° con bocca alta girevole.
Altezza: 27 cm - Interasse: 18 cm.
Single-lever sink mixer 45° with high movable spout.
Height: 27 cm - Interaxis: 20 cm.

**VE13614TC**

Miscelatore lavello monoforo 45° con bocca corta girevole.
Altezza: 25 cm - Interasse: 13 cm.
Single-lever sink mixer 45° with short movable spout.
Height: 25 cm - Interaxis: 13 cm.

**VE13614**

Miscelatore lavello monoforo 45° con canna fusa alta.
Altezza: 25 cm - Interasse: 20 cm.
Single-lever sink mixer 45° with high movable casted spout.
Height: 25 cm - Interaxis: 18 cm.

**VE13614C**

Miscelatore lavello monoforo 45° con bocca alta girevole a "C" tipo lusso, canna fusa corta.
Altezza: 18,5 cm - Interasse: 12,5 cm.
Single-lever sink mixer 45° with "C" high movable spout, luxury type, shorter casted spout.
Height: 18,5 cm - Interaxis: 12,5 cm.

**VE13627**

Miscelatore lavello monoforo bocca alta con doccia estraibile.
Altezza: 34 cm - Interasse: 20 cm.
Single-lever sink mixer high spout with pull-out shower.
Height: 34 cm - Interaxis: 20 cm.

**VE13618**

Miscelatore lavello monoforo 90° con canna fusa alta.
Altezza: 28 cm - Interasse: 20 cm.
Single-lever sink mixer 90° with high movable casted spout.
Height: 28 cm - Interaxis: 20 cm.

**VE13609T**

Miscelatore lavello a muro con bocca girevole.
Lunghezza canna: 20 cm.
Wall-mounted single-lever sink mixer with movable spout.
Length spout: 20 cm.

**VE13609S**

Miscelatore lavello a muro con bocca ad "S" girevole.
Lunghezza canna: 20 cm.
Wall-mounted single-lever sink mixer with "S" movable spout.
Length spout: 20 cm.

**VE13609**

Miscelatore lavello a muro con canna fusa girevole.
Lunghezza canna: 20 cm.
Wall-mounted single lever sink mixer with movable casted spout.
Length spout: 20 cm.

**VE13633**

Miscelatore monocomando per lavello a muro, con leva frontale e bocca girevole.
Altezza: 24 cm - Interasse: 19 cm.
Single-lever wall mounted sink mixer with frontal lever and movable spout.
Height: 24 cm - Interaxis: 19 cm.

**VE13608**

Monocomando lavello con canna fusa girevole.
Altezza: 20 cm - Interasse: 22,5 cm.
Single-lever sink mixer with swiveling casted spout.
Height: 20 cm - Interaxis: 22,5 cm.

**VE13629**

Monocomando lavello monoforo con bocca girevole.
Altezza: 18,5 cm - Interasse: 22 cm.
Single-lever sink mixer with movable casted spout.
Height: 18,5 cm - Interaxis: 22 cm.

**VE13613**

Miscelatore lavello monoforo con doccia estraibile.
Altezza: 16,5 cm - Interasse: 23,5 cm.
Single-lever sink mixer with pull-out shower.
Height: 16,5 cm - Interaxis: 23,5 cm.

VENUS

RIO

SERENA

CONTRACT

ECO

LEVA
CLINICA

MINI

MINI
100



RIO

CARATTERISTICHE TECNICHE:
 La serie è dotata di cartuccia Ø40,
 prodotta da S.T.S.R. Studio Tecnico Sviluppo e
 Ricerche
www.stsr.it

TECHNICAL CHARACTERISTICS:
 The series is equipped with cartridge Ø40,
 produced by S.T.S.R. - Research Development
 Technical Office
www.stsr.it

LAVABI E BIDET - WASHBASIN AND BIDET MIXERS



Monocomando lavabo.
 Altezza: 12,8 cm - Interasse: 12 cm.
Single-lever basin mixer.
 Height: 12,8 cm - Interaxis: 12 cm.

R6605

con scarico.
with pop-up waste.



R6606G

Miscelatore lavabo/lavello con bocca girevole.
 Altezza: 10 cm - Interasse: 14,5 cm.
Single-lever one-hole basin or sink mixer, with
movable spout.
 Height: 10 cm - Interaxis: 14,5 cm.

R6606

senza scarico.
without waste.



Miscelatore bidet.
 Altezza: 12,5 cm - Interasse: 11 cm.
Bidet mixer.
 Height: 12,5 cm - Interaxis: 11 cm.

R6604

con scarico.
with pop-up waste.



R6603

Miscelatore bidet con deviatore, doccetta
 e scarico.
 Interasse: 14 cm.
Bidet mixer with diverter, spray and pop-up
waste.
 Interaxis: 14 cm.

R6607

senza scarico.
without waste.



R6603D

Miscelatore monocomando per bidet, con
 deviatore e doccetta.
Bidet mixer with diverter and spray.

MISCELATORI VASCA E DOCCIA - BATH & SHOWER MIXERS



Miscelatore vasca esterno.
Exposed bath/shower mixer.

R6610 con flessibile cm 150 e doccetta.
with flexible cm 150 and handshower.

R6600 con flessibile cm 120 e doccetta.
with flexible cm 120 and handshower.

R6600H senza kit doccia.
without shower kit.



Miscelatore monocomando vasca con deviatore.
Bathtub single-lever mixer with diverter.

R6606D con kit doccia.
and shower kit.

R6606DH senza kit doccia.
without shower kit.

VENUS

RIO

SERENA

CONTRACT

ECO

LEVA
CLINICA

MINI

MINI
100

Miscelatore lavabo/vasca con canna "S" con deviatore.
Lunghezza canna: 30 cm.
*Exposed basin/bath mixer with "S" spout with diverter.
Length spout: 30 cm.*

R6623S con kit doccia.
and shower kit.

R6623SH senza kit doccia.
without shower kit.



Miscelatore lavabo/vasca con canna fusa con deviatore.
Lunghezza canna: 30 cm.
*Exposed basin/bath mixer with casted spout with diverter.
Length spout: 30 cm.*

R6624 con kit doccia.
and shower kit.

R6624H senza kit doccia.
without shower kit.



R6691
Miscelatore bordo vasca con doccia estraibile.
Bathtub set with pull-out shower.



Miscelatore doccia esterno.
Exposed shower mixer.

R6611A con kit doccia.
and shower kit.

R6611 senza kit doccia.
without shower kit.



Miscelatore doccia esterno con leva frontale.
Exposed shower mixer with frontal lever.

R6631A con kit doccia.
and shower kit.

R6631 senza kit doccia.
without shower kit.

INCASSI DOCCIA - BUILT IN SHOWER MIXER



R6602
Miscelatore doccia incasso.
Built-in shower mixer.



R6612
Miscelatore vasca incasso con deviatore.
Built-in bath/shower mixer with diverter.

BOX INCASSO - BUILT-IN BOX

R6602KB

Set miscelatore doccia da abbinare al box incasso.
Shower mixer set to match with the built-in box.

**DAN BOX**

Box da incasso per miscelatore doccia con deviatore.
Built-in box for shower mixer with diverter.

R6612KB

Set miscelatore doccia con deviatore da abbinare al box incasso.
Shower mixer set with diverter to match with the built-in box.

**DAN BOX**

Box da incasso per miscelatore doccia con deviatore.
Built-in box for shower mixer with diverter.

BOCCE ED ACCESSORI - SPOUTS AND ACCESSORIES



4704
Bocca incasso 15 cm.
Built-in spout 15 cm.



4702
Bocca incasso vasca-doccia, con deviatore integrato 15 cm.
Built-in spout for bath-shower, with integrated diverter 15 cm.



R6630
Maniglia Rio.
Rio lever.

CUCINA - KITCHEN



R6617
Miscelatore lavello monoforo 45° con canna alta "U" girevole.
Altezza: 27 cm - Interasse 22 cm.
Single-lever sink mixer 45° with high movable "U" spout.
Height: 27 cm - Interaxis: 22 cm.



R6614
Miscelatore lavello monoforo 45° con canna fusa alta.
Altezza: 26,5 cm - Interasse 20 cm.
Single-lever sink mixer 45° with high movable casted spout.
Height: 26,5 cm - Interaxis: 20 cm.



R6614R
Miscelatore monocomando per lavello, con bocca alta girevole, tipo lusso.
Altezza: 30 cm - Interasse 19,5 cm.
Single-lever one-hole sink mixer, with high movable spout, luxury type.
Height: 30 cm - Interaxis: 19,5 cm.



R6614T
Miscelatore lavello monoforo 45° con bocca alta girevole.
Altezza: 26,5 cm - Interasse 21,5 cm.
Single-lever sink mixer 45° with high movable spout.
Height: 26,5 cm - Interaxis: 21,5 cm.

**R6614TC**

Miscelatore lavello monoforo 45° con bocca corta girevole.
Altezza: 25 cm - Interasse 13 cm.
Single-lever sink mixer 45° with short movable spout.
Height: 25 cm - Interaxis: 13 cm.

**R6614C**

Miscelatore lavello monoforo 45° con bocca alta girevole a "C" tipo lusso, modello corto.
Altezza: 21,5 cm - Interasse 12,5 cm.
Single-lever sink mixer 45° with "C" high movable spout, luxury type, shorter model.
Height: 21,5 cm - Interaxis: 12,5 cm.

VENUS**RIO****R6618**

Miscelatore lavello monoforo 90° con canna fusa alta.
Altezza: 28 cm - Interasse 20 cm.
Single-lever sink mixer 90° with high movable casted spout.
Height: 28 cm - Interaxis: 20 cm.

**R6627**

Miscelatore lavello monoforo bocca alta con doccia estraibile.
Altezza: 34 cm - Interasse 20 cm.
Single-lever sink mixer high spout with pull-out shower.
Height: 34 cm - Interaxis: 20 cm.

SERENACONTRACTECO**R6609**

Miscelatore lavello a muro con canna fusa girevole.
Lunghezza canna: 20 cm..
Wall-mounted single lever sink mixer with movable casted spout.
Length spout: 20 cm.

**R6609S**

Miscelatore lavello a muro con bocca ad "S" girevole.
Lunghezza canna: 20 cm..
Wall-mounted single-lever sink mixer with "S" movable spout.
Length spout: 20 cm.

LEVA CLINICAMINI**R6609T**

Miscelatore lavello a muro con bocca girevole.
Lunghezza canna: 20 cm..
Wall-mounted single-lever sink mixer with movable spout.
Length spout: 20 cm.

**R6633**

Miscelatore monocomando per lavello a muro, con leva frontale e bocca girevole.
Altezza: 24 cm - Interasse 19 cm.
Single-lever wall mounted sink mixer with frontal lever and movable spout.
Height: 24 cm - Interaxis: 19 cm.

MINI 100**R6613**

Miscelatore lavello monoforo con doccia estraibile.
Altezza: 20 cm - Interasse 22,5 cm.
Single-lever sink mixer with pull-out shower.
Height: 20 cm - Interaxis: 22,5 cm.

**R6629**

Monocomando lavello monoforo con bocca girevole.
Altezza: 18,5 cm - Interasse 22 cm.
Single-lever sink mixer with movable casted spout.
Height: 18,5 cm - Interaxis: 22 cm.

**R6608**

Monocomando lavello con canna fusa girevole.
Altezza: 16,5 cm - Interasse 23,5 cm.
Single-lever sink mixer with swiveling casted spout.
Height: 16,5 cm - Interaxis: 23,5 cm.



SERENA

CARATTERISTICHE TECNICHE:
 La serie è dotata di cartuccia Ø40,
 prodotta da S.T.S.R. Studio Tecnico Sviluppo e
 Ricerche
www.stsr.it

TECHNICAL CHARACTERISTICS:
 The series is equipped with cartridge Ø40,
 produced by S.T.S.R. - Research Development
 Technical Office
www.stsr.it

MANIGLIE DISPONIBILI:
 AVAILABLE HANDLES:



Maniglia SA
 SA Lever



Maniglia SB
 SB Lever



Maniglia SC
 SC Lever

LAVABI E BIDET - WASHBASIN AND BIDET MIXERS



Monocomando lavabo.
 Altezza: 14 cm - Interasse: 9 cm.
 Single-lever basin mixer.
 Height: 14 cm - Interaxis: 9 cm.

SA1605

con scarico.
 with pop-up waste.

SA1605A

con scarico lin plastica.
 with plastic pop-up waste.

SA1606

senza scarico.
 without waste.



Miscelatore bidet con scarico.
 Altezza: 11,5 cm - Interasse: 9,5 cm.
 Bidet mixer with pop-up waste.
 Height: 11,5 cm - Interaxis: 9,5 cm.

SA1604

con scarico.
 with pop-up waste.

SA1604A

con scarico lin plastica.
 with plastic pop-up waste.

SA1607

senza scarico.
 without waste.



SA1606G

Miscelatore lavabo/lavello con bocca girevole.
 Altezza: 10 cm - Interasse: 14,5 cm.
 Single-lever one-hole basin or sink mixer,
 with movable spout.
 Height: 10 cm - Interaxis: 14,5 cm.



SA1603

Miscelatore bidet con deviatore doccia e
 scarico.
 Bidet mixer with diverter, spray and pop-up
 waste.

MISCELATORI VASCA E DOCCIA - BATH & SHOWER MIXERS



Miscelatore vasca esterno.
Exposed bath/shower mixer.

SA1610 con flessibile cm 150 e doccetta.
with flexible cm 150 and handshower.

SA1600 con flessibile cm 120 e doccetta.
with flexible cm 120 and handshower.

SA1600H senza kit doccia.
without shower kit.

SA1600SD Miscelatore vasca esterno senza deviatore e senza kit doccia.
Exposed bath/shower mixer without diverter and without shower kit.



Miscelatore lavabo/vasca con canna fusa con deviatore.
Lunghezza canna: 30 cm.
*Exposed basin/bath mixer with casted spout with diverter.
Lenght spout: 30 cm.*

SA1624 con kit doccia.
and shower kit.

SA1624H senza kit doccia.
without shower kit.



Miscelatore doccia esterno.
Exposed shower mixer.

SA1611A con kit doccia.
and shower kit.

SA1611 senza kit doccia.
without shower kit.



Miscelatore monocomando vasca con deviatore.
Bath tub single-lever mixer with diverter.

SA1606D con kit doccia.
and shower kit.

SA1606DH senza kit doccia.
without shower kit.



SA1691 Miscelatore bordo vasca con doccia estraibile.
Bath tub set with pull-out shower.



Miscelatore lavabo/vasca con canna tubo con deviatore.
Lunghezza canna: 30 cm.
*Exposed basin/bath mixer with tube spout with diverter.
Lenght spout: 30 cm.*

SA1623 con kit doccia.
and shower kit.

SA1623H senza kit doccia.
without shower kit.



Miscelatore doccia esterno con leva frontale.
Exposed shower mixer with frontal lever.

SA1631A con kit doccia.
and shower kit.

SA1631 senza kit doccia.
without shower kit.

VENUS

RIO

SERENA

CONTRACT

ECO

LEVA
CLINICA

MINI

MINI
100

BOCCE ED ACCESSORI - SPOUTS AND ACCESSORIES



4704 Bocca incasso 15 cm.
Built-in spout 15 cm.



A1630 Maniglia Serena.
Serena handle.



4702 Bocca incasso vasca-doccia, con deviatore integrato 15 cm.
Built-in spout for bath-shower, with integrated diverter 15 cm.

INCASSI DOCCIA - BUILT IN SHOWER MIXER



SA1602
Miscelatore doccia incasso.
Built-in shower mixer.



SA1612
Miscelatore vasca incasso con deviatore.
Built-in bath/shower mixer with diverter.

BOX INCASSO - BUILT-IN BOX

SA1602KB

Set miscelatore doccia da abbinare al box incasso.
Shower mixer set to match with the built-in box.



DAN BOX

Box da incasso per miscelatore doccia con deviatore.
Built-in box for shower mixer with diverter.

SA1612KB

Set miscelatore doccia con deviatore da abbinare al box incasso.
Shower mixer set with diverter to match with the built-in box.



DAN BOX

Box da incasso per miscelatore doccia con deviatore.
Built-in box for shower mixer with diverter.

CUCINA - KITCHEN



SA1614R
Miscelatore monocomando per lavello, con bocca alta girevole, tipo lusso.
Altezza: 30 cm - Interasse: 19,5 cm.
Single-lever one-hole sink mixer, with high movable spout, luxury type.
Height: 30 cm - Interaxis: 19,5 cm.



SA1617
Miscelatore lavello monoforo 45° con canna alta "U" girevole.
Altezza: 27 cm - Interasse: 22 cm.
Single-lever sink mixer 45° with high movable "U" spout.
Height: 27 cm - Interaxis: 22 cm.



SA1627
Miscelatore lavello monoforo bocca alta con doccia estraibile.
Altezza: 34 cm - Interasse: 20 cm.
Single-lever sink mixer high spout with pull-out shower.
Height: 34 cm - Interaxis: 20 cm.



SA1618
Miscelatore lavello monoforo 90° con canna fusa alta.
Altezza: 28 cm - Interasse: 20 cm.
Single-lever sink mixer 90° with movable casted spout.
Height: 28 cm - Interaxis: 20 cm.



SA1614
Miscelatore lavello monoforo 45° con canna fusa alta.
Altezza: 25 cm - Interasse: 20 cm.
Single-lever sink mixer 45° with high movable casted spout.
Height: 25 cm - Interaxis: 20 cm.



SA1614T
Miscelatore lavello monoforo 45° con bocca alta girevole.
Altezza: 28 cm - Interasse: 20 cm.
Single-lever sink mixer 45° with high movable spout.
Height: 28 cm - Interaxis: 20 cm.

**SA1614C**

Miscelatore lavello monoforo 45° con canna fusa corta.
Altezza: 21,5 cm - Interasse: 12,5 cm.
Single-lever sink mixer 45° with short movable casted spout.
Height: 21,5 cm - Interaxis: 12,5 cm.

**SA1614TC**

Miscelatore lavello monoforo 45° con bocca corta girevole.
Altezza: 25 cm - Interasse: 13 cm.
Single-lever sink mixer 45° with short movable spout.
Height: 25 cm - Interaxis: 13 cm.

VENUS

**SA1633**

Miscelatore monocomando per lavello a muro, con leva frontale e bocca girevole.
Altezza: 26 cm - Interasse: 19 cm.
Single-lever wall mounted sink mixer with frontal lever and movable spout.
Height: 26 cm - Interaxis: 19 cm.

**SA1609**

Miscelatore lavello a muro con canna fusa girevole.
Lunghezza canna: 20 cm.
Wall-mounted single lever sink mixer with movable casted spout.
Length spout: 20 cm.

RIO

SERENA

CONTRACT

**SA1609S**

Miscelatore lavello a muro con bocca ad "S" girevole.
Lunghezza canna: 20 cm.
Wall-mounted single-lever sink mixer with "S" movable spout.
Length spout: 20 cm.

**SA1609T**

Miscelatore lavello a muro con bocca girevole.
Lunghezza canna: 20 cm.
Wall-mounted single-lever sink mixer with movable spout.
Length spout: 20 cm.

ECO

LEVA
CLINICA

MINI

**SA1608**

Monocomando lavello con canna fusa girevole.
Altezza: 16,5 cm - Interasse: 23,5 cm.
Single-lever sink mixer with swiveling casted spout.
Height: 16,5 cm - Interaxis: 23,5 cm.

**SA1613**

Miscelatore lavello monoforo con doccia estraibile.
Altezza: 20 cm - Interasse: 22,5 cm.
Single-lever sink mixer with pull-out shower.
Height: 20 cm - Interaxis: 22,5 cm.

MINI
100**SA1629**

Miscelatore lavello monoforo bocca girevole.
Altezza: 18,5 cm - Interasse 24 cm.
Single-lever sink mixer with swiver spout.
Height: 18,5 cm - Interaxis: 24 cm.

CON SELETTORE ACQUA POTABILE - WITH SELECTOR FOR DRINKING WATER

**SA1622**

Miscelatore lavello monoforo con selettore acqua potabile (tre vie di ingresso).
Altezza: 22 cm - Interasse: 22 cm.
Single-lever sink mixer with selector for drinking water (3 ways inlet).
Height: 22 cm - Interaxis: 22 cm.



CONTRACT

CARATTERISTICHE TECNICHE:
 La serie è dotata di cartuccia Ø40,
 prodotta da S.T.S.R. Studio Tecnico
 Sviluppo e Ricerche
www.stsr.it

TECHNICAL CHARACTERISTICS:
 The series is equipped with cartridge Ø40,
 produced by S.T.S.R. - Research
 Development Technical Office
www.stsr.it

LAVABI E BIDET - WASHBASIN AND BIDET MIXERS



Monocomando lavabo.
 Altezza: 18,5 cm - Interasse: 12,5 cm.
Single-lever basin mixer.
 Height: 18,5 cm - Interaxis: 12,5 cm.

CT13605

con scarico.
with pop-up waste.



Miscelatore bidet con scarico.
 Altezza: 15 cm - Interasse: 10,5 cm.
Bidet mixer with pop-up waste.
 Height: 15 cm - Interaxis: 10,5 cm.

CT13604

con scarico.
with pop-up waste.

CT13606

senza scarico.
without waste.

CT13607

senza scarico.
without waste.



CT13606G

Miscelatore lavabo/lavello con bocca girevole.
 Altezza: 10 cm - Interasse: 14,5 cm.
*Single-lever one-hole basin or sink mixer, with
 movable spout.*
 Height: 10 cm - Interaxis: 14,5 cm.

MISCELATORI VASCA E DOCCIA - BATH & SHOWER MIXERS



Miscelatore vasca esterno.
Exposed bath/shower mixer.

CT13610 con flessibile cm 150 e doccetta.
with flexible cm 150 and handshower.

CT13600 con flessibile cm 120 e doccetta.
with flexible cm 120 and handshower.

CT13600H senza kit doccia.
without shower kit.



Miscelatore lavabo/vasca con canna fusa con deviatore.
Lunghezza canna: 30 cm.
Exposed basin/bath mixer with casted spout with diverter. Length spout: 30 cm.

CT13624 con kit doccia.
and shower kit.

CT13624H senza kit doccia.
without shower kit.



CT13691
Miscelatore bordo vasca con doccia estraibile.
Bathtub set with pull-out shower.



CT13698
Miscelatore bordo vasca con doccia estraibile e bocca con getto a cascata.
Bathtub set with pull-out shower and deck with waterfall jet.



Miscelatore doccia esterno.
Exposed shower mixer.

CT13611A con kit doccia.
and shower kit.

CT13611 senza kit doccia.
without shower kit.



Miscelatore doccia esterno con leva frontale.
Exposed shower mixer with frontal lever.

CT13631A con kit doccia.
and shower kit.

CT13631 senza kit doccia.
without shower kit.

VENUS

RIO

SERENA

CONTRACT

ECO

LEVA
CLINICA

MINI

MINI
100

BOCCE ED ACCESSORI - SPOUTS AND ACCESSORIES



4704
Bocca incasso 15 cm.
Built-in spout 15 cm.



4702
Bocca incasso vasca-doccia, con deviatore integrato 15 cm.
Built-in spout for bath-shower, with integrated diverter 15 cm.



B1630
Maniglia Contract.
Contract handle.

INCASSI DOCCIA - BUILT IN SHOWER MIXER



CT13602
Miscelatore doccia incasso.
Built-in shower mixer.



CT13612
Miscelatore vasca incasso con deviatore.
Built-in bath/shower mixer with diverter.

BOX INCASSO - BUILT-IN BOX

CT13602KB

Set miscelatore doccia da abbinare al box incasso.
Shower mixer set to match with the built-in box.



DAN BOX

Box da incasso per miscelatore doccia con deviatore.
Built-in box for shower mixer with diverter.

CT13612KB

Set miscelatore doccia con deviatore da abbinare al box incasso.
Shower mixer set with diverter to match with the built-in box.



DAN BOX

Box da incasso per miscelatore doccia con deviatore.
Built-in box for shower mixer with diverter.

CUCINA - KITCHEN



CT13614R

Miscelatore monocomando per lavello, con bocca alta girevole, tipo lusso.
Altezza: 30 cm - Interasse: 19,5 cm.
Single-lever one-hole sink mixer, with high movable spout, luxury type.
Heigt: 30 cm - Interaxis: 19,5 cm.



CT13617

Miscelatore lavello monoforo 45° con canna alta "U" girevole.
Altezza: 27 cm - Interasse: 22 cm.
Single-lever sink mixer 45° with high movable "U" spout.
Heigt: 27 cm - Interaxis: 22 cm.



CT13618

Miscelatore lavello monoforo 90° con canna fusa alta.
Altezza: 28 cm - Interasse: 20 cm.
Single-lever sink mixer 90° with high movable casted spout.
Heigt: 28 cm - Interaxis: 20 cm.

€ 101,40



CT13614

Miscelatore lavello monoforo 45° con canna fusa alta.
Altezza: 25 cm - Interasse: 20 cm.
Single-lever sink mixer 45° with high movable casted spout.
Heigt: 25 cm - Interaxis: 20 cm.

**CT13614T**

Miscelatore lavello monoforo 45° con bocca alta girevole.
Altezza: 28 cm - Interasse: 20 cm.
Single-lever sink mixer 45° with high movable spout.
Heigt: 28 cm - Interaxis: 20 cm.

**CT13614C**

Miscelatore lavello monoforo 45° con canna fusa corta.
Altezza: 21,5 cm - Interasse: 12,5 cm.
Single-lever sink mixer 45° with short movable casted spout.
Heigt: 21,5 cm - Interaxis: 12,5 cm.

**CT13614TC**

Miscelatore lavello monoforo 45° con bocca corta girevole.
Altezza: 25 cm - Interasse: 13 cm.
Single-lever sink mixer 45° with short movable spout.
Heigt: 25 cm - Interaxis: 13 cm.

**CT13633**

Miscelatore monocomando per lavello a muro, con leva frontale e bocca girevole.
Altezza: 26 cm - Interasse: 19 cm.
Single-lever wall mounted sink mixer with frontal lever and movable spout.
Heigt: 26 cm - Interaxis: 19 cm.

**CT13609T**

Miscelatore lavello a muro con bocca girevole.
Lunghezza canna: 20 cm.
Wall-mounted single-lever sink mixer with movable spout.
Lenght spout 20 cm.

**CT13609**

Miscelatore lavello a muro con canna fusa girevole.
Lunghezza canna: 20 cm.
Wall-mounted single-lever sink mixer with movable casted spout.
Lenght spout 20 cm.

**CT13609S**

Miscelatore lavello a muro con bocca ad "S" girevole.
Lunghezza canna: 20 cm.
Wall-mounted single-lever sink mixer with "S" movable spout.
Lenght spout 20 cm.

**CT13629**

Monocomando lavello con canna girevole.
Altezza: 16 cm - Interasse 22 cm.
Single-lever sink mixer with swiveling spout.
Heigt: 16 cm - Interaxis: 22 cm.

**CT13608**

Monocomando lavello con canna fusa girevole.
Altezza: 16,5 cm - Interasse: 23,5 cm.
Single-lever sink mixer with swiveling casted spout.
Heigt: 16,5 cm - Interaxis: 23,5 cm.

**CT13613**

Miscelatore lavello monoforo con doccia estraibile.
Altezza: 20 cm - Interasse: 22 cm.
Single-lever sink mixer with pull-out shower.
Heigt: 20 cm - Interaxis: 22 cm.

VENUS

RIO

SERENA

CONTRACT

ECO

LEVA
CLINICA

MINI

MINI
100



ECO

CARATTERISTICHE TECNICHE:
La serie è dotata di cartuccia Ø40,
prodotta da S.T.S.R. Studio Tecnico Sviluppo e
Ricerche
www.stsr.it

TECHNICAL CHARACTERISTICS:
The series is equipped with cartridge Ø40,
produced by S.T.S.R. - Research Development
Technical Office
www.stsr.it

MANIGLIE DISPONIBILI:
AVAILABLE HANDLES:



Maniglia Star ES
Star Lever ES



Maniglia Medea EM
Medea Lever EM



Maniglia Kim EK
Kim Lever EK

LAVABI E BIDET - WASHBASIN AND BIDET MIXERS



Monocomando lavabo.
Altezza: 12 cm - Interasse: 11 cm.
*Single-lever basin mixer.
Height: 12 cm - Interaxis: 11 cm.*

ES5605

con scarico.
with pop-up waste.

ES5605A

con scarico in plastica.
with plastic pop-up waste.

ES5606

senza scarico.
without waste.



ES5643

Miscelatore lavabo con bocca lunga con
scarico.
Altezza: 13 cm - Interasse: 14 cm.
*Basin mixer with long body with pop-up
waste.
Height: 13 cm - Interaxis: 14 cm.*



ES5605P

Miscelatore monocomando lavabo con
bocca estraibile e scarico.
*Single-lever basin mixer with pull-out spout
and pop-up waste.*



ES5606G

Miscelatore lavabo/lavello con bocca
girevole.
*Single-lever basin or sink mixer with
movable spout.*



Miscelatore bidet con scarico.
Altezza: 12 cm - Interasse: 13 cm.
*Bidet mixer with pop-up waste.
Height: 12 cm - Interaxis: 13 cm.*

ES5604 con scarico.
with pop-up waste.

ES5604A con scarico in plastica.
with plastic pop-up waste.

ES5607 senza scarico.
without waste.



ES5603
Miscelatore bidet con deviatore doccetta e scarico.
Bidet mixer with diverter, spray and pop-up waste.



ES5603D
Miscelatore monocomando per bidet, con deviatore e doccetta.
Bidet mixer with diverter and spray.

VENUS

RIO

SERENA

CONTRACT

ECO

LEVA
CLINICA

MINI

MINI
100

MISCELATORI VASCA E DOCCIA - BATH & SHOWER MIXERS



Miscelatore vasca esterno.
Exposed bath/shower mixer.

ES5610 con flessibile cm 150 e doccetta.
with flexible cm 150 and handshower.

ES5600 con flessibile cm 120 e doccetta.
with flexible cm 120 and handshower.

ES5600H senza kit doccia.
without shower kit.

ES5600SD Miscelatore vasca esterno senza deviatore e senza kit doccia.
Exposed bath/shower mixer without diverter and without shower kit.



Miscelatore monocomando vasca con deviatore.
Bathtub single-lever mixer with diverter.

ES5606D con kit doccia.
and shower kit.

ES5606DH senza kit doccia.
without shower kit.



ES5691
Miscelatore bordo vasca con doccia estraibile.
Bathtub set with pull-out shower.



ES5610UK
Gruppo vasca esterno su colonnette, con doccia duplex.
Bathtub mixer, external, on columns, with duplex shower.



Miscelatore lavabo/vasca con canna "S" con deviatore.
Lunghezza canna: 30 cm.
*Exposed basin/bath mixer with "S" spout with diverter.
Length spout: 30 cm.*

ES5623S con kit doccia.
and shower kit.

ES5623SH senza kit doccia.
without shower kit.



Miscelatore lavabo/vasca con canna fusa con deviatore.
Lunghezza canna: 30 cm.
*Exposed basin/bath mixer with casted spout with diverter.
Length spout: 30 cm.*

ES5624 con kit doccia.
and shower kit.

ES5624H senza kit doccia.
without shower kit.

ECO



Miscelatore lavabo/vasca con canna tubo con deviatore. Lunghezza canna: 30 cm. *Exposed basin/bath mixer with tube spout with diverter. Length spout: 30 cm.*

ES5623

con kit doccia.
and shower kit.

ES5623H

senza kit doccia.
without shower kit.



Miscelatore doccia esterno. *Exposed shower mixer.*

ES5611A

con kit doccia.
and shower kit.

ES5611

senza kit doccia.
without shower kit.



Miscelatore doccia esterno con leva frontale. *Exposed shower mixer with frontal lever.*

ES5631A

con kit doccia.
and shower kit.

ES5631

senza kit doccia.
without shower kit.

INCASSI DOCCIA - BUILT IN SHOWER MIXER



ES5602

Miscelatore doccia incasso. *Built-in shower mixer.*



ES5612

Miscelatore vasca incasso con deviatore. *Built-in bath/shower mixer with diverter.*

BOX INCASSO - BUILT-IN BOX

ES5602KB

Set miscelatore doccia da abbinare al box incasso. *Shower mixer set to match with the built-in box.*



+



DAN BOX

Box da incasso per miscelatore doccia con deviatore. *Built-in box for shower mixer with diverter.*

ES5612KB

Set miscelatore doccia con deviatore da abbinare al box incasso. *Shower mixer set with diverter to match with the built-in box.*



+



DAN BOX

Box da incasso per miscelatore doccia con deviatore. *Built-in box for shower mixer with diverter.*

BOCCE ED ACCESSORI - SPOUTS AND ACCESSORIES

**4704**

Bocca incasso 15 cm.
Built-in spout 15 cm.

**4702**

Bocca incasso vasca-doccia, con deviatore integrato, 15 cm.
Built-in spout for bath-shower, with integrated diverter, 15 cm.

**ES5630**

Maniglia Eco.
Eco handle.

VENUS

RIO

SERENA

CONTRACT

LINEA PARRUCCHIERE - BARBER LINE

**ES5601**

Mixer per parrucchiere completo con doccia estraibile.
Barber mixer complete with pull-out shower.

ECO

CUCINA - KITCHEN

**ES5617**

Miscelatore lavello monoforo 45° con canna alta "U" girevole.
Altezza: 27 cm - Interasse 22 cm.
Single-lever sink mixer 45° with high movable "U" spout.
Height: 27 cm - Interaxis 22 cm.

**ES5614R**

Miscelatore monocomando per lavello, con bocca alta girevole, tipo lusso.
Altezza: 30 cm - Interasse 19,5 cm.
Single-lever one-hole sink mixer, with high movable spout, luxury type.
Height: 30 cm - Interaxis 19,5 cm.

LEVA
CLINICA

MINI

**ES5627**

Miscelatore lavello monoforo bocca alta con doccia estraibile.
Altezza: 34 cm - Interasse: 20 cm.
Single-lever sink mixer high spout with pull-out shower.
Height: 34 cm - Interaxis 20 cm.

**ES5618**

Miscelatore lavello monoforo 90° con canna fusa alta.
Altezza: 28 cm - Interasse: 20 cm.
Single-lever sink mixer 90° with high movable casted spout.
Height: 28 cm - Interaxis 20 cm.

MINI
100**ES5614**

Miscelatore lavello monoforo 45° con canna fusa alta.
Altezza: 25 cm - Interasse: 20 cm.
Single-lever sink mixer 45° with high movable casted spout.
Height: 25 cm - Interaxis 20 cm.

**ES5614T**

Miscelatore lavello monoforo 45° con bocca alta girevole.
Altezza: 28 cm - Interasse: 20 cm.
Single-lever sink mixer 45° with high movable spout.
Height: 28 cm - Interaxis 20 cm.

**ES5614C**

Miscelatore lavello monoforo 45° con canna fusa corta.
Altezza: 21,5 cm - Interasse: 12,5 cm.
Single-lever sink mixer 45° with short movable casted spout.
Height: 21,5 cm - Interaxis 12,5 cm.

**ES5614TC**

Miscelatore lavello monoforo 45° con bocca corta girevole.
Altezza: 25 cm - Interasse: 13 cm.
Single-lever sink mixer 45° with short movable spout.
Height: 25 cm - Interaxis 13 cm.

ECO



ES5609

Miscelatore lavello a muro con canna fusa girevole.
Lunghezza canna: 20 cm.
Wall-mounted single lever sink mixer with movable casted spout.
Lenght spout: 20 cm.



ES5609S

Miscelatore lavello a muro con bocca ad "S" girevole.
Lunghezza canna: 20 cm.
Wall-mounted single-lever sink mixer with "S" movable spout.
Lenght spout: 20 cm.



ES5609T

Miscelatore lavello a muro con bocca girevole.
Lunghezza canna: 20 cm.
Wall-mounted single-lever sink mixer with movable spout.
Lenght spout: 20 cm.



ES5633

Miscelatore monocomando per lavello a muro, con leva frontale e bocca girevole.
Altezza: 26 cm - Interasse: 19 cm.
Single-lever wall mounted sink mixer with frontal lever and movable spout.
Height: 26 cm - Interaxis 19 cm.



ES5613

Miscelatore lavello monoforo con doccia estraibile.
Altezza: 20 cm - Interasse: 22,5 cm.
Single-lever sink mixer with pull-out shower.
Height: 20 cm - Interaxis 22,5 cm.



ES5608

Monocomando lavello con canna fusa girevole.
Altezza: 16,5 cm - Interasse: 23,5 cm.
Single-lever sink mixer with swiveling casted spout.
Height: 16,5 cm - Interaxis 23,5 cm.



ES5629

Miscelatore lavello monoforo bocca girevole.
Altezza: 17 cm - Interasse: 24 cm.
Single-lever sink mixer with movable spout.
Height: 17 cm - Interaxis 24 cm.

CON SELETTORE ACQUA POTABILE - WITH SELECTOR FOR DRINKING WATER



ES5629DW

Miscelatore lavello a tre vie di ingresso con bocca girevole, con selezione acqua potabile tramite leva, con 2 aeratori in uscita.
Altezza: 20 cm - Interasse: 23 cm.
Tree ways inlet single lever sink mixer, with movable spout, with selection for drinking water directly from the lever, with 2 exit aerators.
Height: 20 cm - Interaxis 23 cm.



ES5622

Miscelatore lavello monoforo con selettore acqua potabile (3 vie d'ingresso).
Altezza: 22 cm - Interasse: 22 cm.
Single-lever sink mixer with selector for drinking water (3 ways inlet).
Height: 22 cm - Interaxis 22 cm.

BASSA PRESSIONE - LOW PRESSURE



ES5641

Miscelatore per lavello o lavabo con bocca girevole corta per bassa pressione.
Altezza: 10 cm - Interasse: 14,5 cm.
Single-lever basin or sink mixer, with short movable spout, for low pressure.
Height: 10 cm - Interaxis 14,5 cm.



ES5642

Miscelatore monocomando per lavello a muro, con bocca girevole, per bassa pressione.
Lunghezza canna: 19 cm.
Wall mounted sink mixer with movable spout for low pressure.
Lenght spout: 19 cm.



ES5615

Miscelatore lavello monoforo con canna girevole, per bassa pressione.
Altezza: 18,5 cm - Interasse: 22 cm.
Single-lever sink mixer, with swiveling spout, for low pressure.
Height: 18,5 cm - Interaxis 22 cm.

MONO ACQUA - SINGLE WATER

I rubinetti della linea mono acqua usano gli stessi principi dei miscelatori monocomando ma gestiscono il flusso di una sola acqua (generalmente l'acqua fredda) e sono alimentati da un singolo flessibile. Girando la leva a destra e sinistra riceverete sempre acqua della stessa tipologia di temperatura mentre alzando e abbassando la leva ne regolerete la quantità di flusso come nei normali monocomando.

The single water line taps use the same principles of the single lever mixers but they flow only one water (generally cold water) and they're supplied by a single flexible hose.

Turning the handle on the right and on the left side you will always receive cold water while opening and closing the lever you regulate the flow as usual.

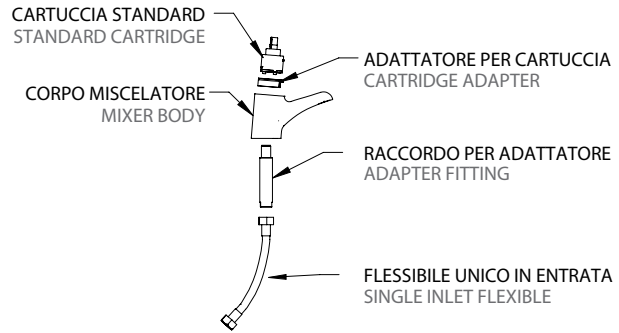

Monocomando lavabo monoacqua.
Altezza: 12 cm - Interasse: 11 cm.
Single-lever single-water line basin mixer with click-clack waste.
Height: 12 cm - Interaxis: 11 cm.

ES5605M

con scarico click-clack.
with pop-up waste.

**ES5606GM**

Miscelatore monocomando e monoacqua per lavabo o lavello, con bocca girevole.
Single-lever single-water line basin or sink mixer, with movable spout.

ES5606M

senza scarico.
without waste.

**ES5614TM**

Miscelatore monocomando mono acqua per lavello, con bocca alta girevole.
Altezza: 25 cm - Interasse: 20 cm.
Single-lever single-water one-hole sink mixer, with high movable spout.
Height: 25 cm - Interaxis 20 cm.

**ES5614CM**

Miscelatore monocomando mono acqua per lavello, con bocca alta girevole, tipo lusso, modello corto.
Altezza: 21,5 cm - Interasse: 12,5 cm.
Single-lever single-water one-hole sink mixer, with high movable spout, shorter model, luxury type.
Height: 21,5 cm - Interaxis 12,5 cm.

**ES5614TCM**

Miscelatore monocomando mono acqua per lavello, con bocca alta girevole, modello corto.
Altezza: 25 cm - Interasse: 13 cm.
Single-lever single-water one-hole sink mixer, with high movable spout, shorter model.
Height: 25 cm - Interaxis 13 cm.

**ES5617M**

Miscelatore monocomando monoacqua per lavello, con bocca alta a "U" girevole.
Altezza: 27 cm - Interasse 22 cm.
Single-lever single water one-hole sink mixer, with high "U" movable spout.
Height: 27 cm - Interaxis 22 cm.

**ES5613M**

Miscelatore monocomando monoacqua per lavello, con doccia estraibile a getto variabile.
Altezza: 20 cm - Interasse: 22,5 cm.
Single-lever single water one-hole sink mixer, with pull-out spray jet shower two functions.
Height: 20 cm - Interaxis 22,5 cm.

**ES5629M**

Miscelatore monocomando mono acqua per lavello, con bocca girevole.
Altezza: 17 cm - Interasse: 24 cm.
Single-lever single-water one-hole sink mixer, with movable spout.
Height: 17 cm - Interaxis 24 cm.

VENUS

RIO

SERENA

CONTRACT

ECO

LEVA
CLINICA

MINI

MINI
100



LEVA CLINICA LONG LEVER

CARATTERISTICHE TECNICHE:
La serie è dotata di cartuccia Ø40,
prodotta da S.T.S.R. Studio Tecnico
Sviluppo e Ricerche
www.stsr.it

TECHNICAL CHARACTERISTICS:
The series is equipped with cartridge Ø40,
produced by S.T.S.R. - Research
Development Technical Office
www.stsr.it



S8630L
Leva lunga.
Long lever.

LAVABI - WASHBASIN MIXERS



S5643L
Miscelatore lavabo con bocca lunga,
scarico e leva lunga
Wash basin mixer with long spout, pop-up
waste and long lever



S5605L
Miscelatore lavabo con scarico e leva
lunga.
Wash basin mixer with pop-up waste
and long lever.

MISCELATORI DOCCIA - SHOWER MIXERS



Miscelatore monocomando esterno per doccia.
Wall mounted single-lever shower mixer.

S5611AL con kit doccia e leva lunga.
with shower kit and long lever.

S5611L senza kit doccia e leva lunga.
without shower kit and long lever.

VENUS

RIO

SERENA

CONTRACT

ECO

CUCINA - KITCHEN



S5618L
Miscelatore monocomando per lavello, con bocca alta girevole e leva lunga.
Altezza: 27 cm - Interasse: 20 cm.
Single-lever one-hole sink mixer, with high movable spout and long lever.
Height: 27 cm - Interaxis: 20 cm.



S5609L
Miscelatore lavello a muro con leva lunga.
Lunghezza canna: 20 cm.
Wall-mounted sink mixer with long lever.
Length spout: 20 cm.



S5608L
Miscelatore lavello monoforo bocca girevole con leva lunga.
Altezza: 22,5 cm - Interasse: 22 cm.
Single-lever sink mixer with movable spout and long lever.
Height: 22,5 cm - Interaxis: 22 cm.



S5613L
Miscelatore monocomando per lavello con leva lunga e doccia estraibile.
Altezza: 20 cm - Interasse: 22 cm.
Single-lever one-hole sink mixer with long lever and with pull-out spray shower.
Height: 20 cm - Interaxis: 22 cm.

LEVA CLINICA

MINI

MINI
100



MINI

CARATTERISTICHE TECNICHE:
 La serie è dotata di cartuccia a dischi ceramici Ø35,
 prodotta da S.T.S.R. Studio Tecnico Sviluppo e
 Ricerche
www.stsr.it

TECHNICAL CHARACTERISTICS:
 The series is equipped with ceramic cartridge Ø35,
 produced by S.T.S.R. - Research Development
 Technical Office
www.stsr.it

MANIGLIE DISPONIBILI:
AVAILABLE HANDLES:



Maniglia M
M Lever



Maniglia MA
MA Lever



Maniglia MR
MR Lever



Maniglia MT
MT Lever



Maniglia MW
MW Lever

LAVABI E BIDET - WASHBASIN AND BIDET MIXERS



Monocomando lavabo.
 Altezza: 11,5 cm - Interasse: 10 cm.
Single-lever basin mixer.
Height: 11,5 cm - Interaxis: 10 cm.

MT16605

con scarico.
with pop-up waste.

MT16605A

con scarico in plastica.
with plastic pop-up waste.

MT16606

senza scarico.
without waste.



Monocomando bidet.
 Altezza: 12 cm - Interasse: 11,5 cm.
Single-lever bidet mixer.
Height: 12 cm - Interaxis: 11,5 cm.

MT16604

con scarico.
with pop-up waste.

MT16604A

con scarico in plastica.
with plastic pop-up waste.

MT16607

senza scarico.
without waste.



MT16606G

Miscelatore lavabo/lavello con bocca girevole.
single-lever one-hole basin or sink mixer,
with movable spout.



MT16603

Miscelatore monocomando per bidet, con
 doccetta.
Single-lever bidet mixer with spray.

MISCELATORI VASCA E DOCCIA - BATH & SHOWER MIXERS



Miscelatore vasca esterno.
Exposed bath/shower mixer.

MT16610 con flessibile cm 150 e doccetta.
with flexible cm 150 and handshower.

MT16600H senza kit doccia.
without shower kit.



MT16691
Miscelatore bordo vasca con doccia estraibile.
Bathtub set with pull-out shower.



MT16698
Batteria bordo vasca con bocca a cascata e doccia estraibile.
Bathtub set with pull-out shower and waterfall spout.



Miscelatore lavabo/vasca con canna "S" e deviatore.
Lunghezza canna: 30 cm
Exposed basin/bath mixer with "S" spout with diverter. Length spout: 30 cm.

MT16623S con flessibile cm 150 e doccetta.
with flexible cm 150 and handshower.

MT16623SH senza kit doccia.
without shower kit.

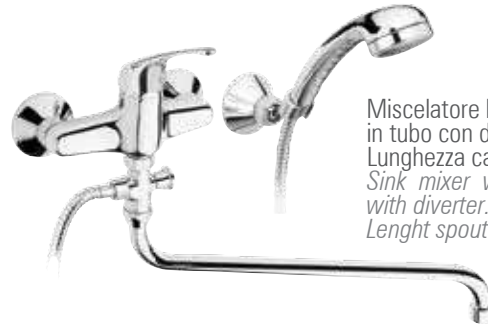

Miscelatore lavello con canna in tubo con deviatore.
Lunghezza canna: 40 cm.
Sink mixer with tube spout, with diverter. Length spout: 40 cm.

MT16623 con flessibile cm 150 e doccetta.
with flexible cm 150 and handshower.

MT16623H senza kit doccia.
without shower kit.



Miscelatore lavabo/vasca con canna fusa e deviatore.
Lunghezza canna: 30 cm.
Wall basin/bath single-lever mixer with casted spout, with diverter. Length spout: 30 cm.

MT16624 con flessibile cm 150 e doccetta.
with flexible cm 150 and handshower.

MT16624H senza kit doccia.
without shower kit.



Miscelatore monocomando esterno per doccia.
Wall mounted single-lever shower mixer.

MT16611A con flessibile cm 150 e doccetta.
with flexible cm 150 and handshower.

MT16611 senza kit doccia.
without shower kit.



Miscelatore monocomando esterno per doccia, con leva frontale.
Wall mounted single-lever shower mixer, with frontal lever.

MT16631A con flessibile cm 150 e doccetta.
with flexible cm 150 and handshower.

MT16631 senza kit doccia.
without shower kit.



MT16631Z
Gruppo doccia esterno, attacco 3/4 per colonna doccia.
Wall mounted shower mixer with connection 3/4 for columns.

VENUS

RIO

SERENA

CONTRACT

ECO

LEVA
CLINICA

MINI

MINI
100

COLONNE DOCCIA - SHOWER COLUMN



MT16637

Gruppo doccia con colonna e soffione doccia standard.
Shower wall-mounted mixer with column and standard shower head.



MT16636

Gruppo doccia con colonna saliscendi e deviatore, completa di doccetta anticalcare 4 getti, flessibile e soffione anticalcare.
Shower wall-mounted mixer with sliding rail column and diverter, complete with handshower anti-limestone 4 jets, flexible hose and shower head anti-limestone.

INCASSI DOCCIA - BUILT IN SHOWER MIXER



MT16602

Miscelatore doccia incasso.
Built-in shower mixer.



MT16612

Miscelatore vasca incasso con deviatore.
Built-in bath/shower mixer with diverter.

BOX INCASSO - BUILT-IN BOX

MT16602KB

Set miscelatore doccia da abbinare al box incasso.
Shower mixer set to match with the built-in box.



DAN BOX

Box da incasso per miscelatore doccia con deviatore.
Built-in box for shower mixer with diverter.

MT16612KB

Set miscelatore doccia con deviatore da abbinare al box incasso.
Shower mixer set with diverter to match with the built-in box.



DAN BOX

Box da incasso per miscelatore doccia con deviatore.
Built-in spout for shower mixer with diverter.

BOCCHIE ED ACCESSORI - SPOUTS AND ACCESSORIES



4704

Bocca incasso 15 cm.
Built-in spout 15 cm.



M3630

Maniglia Mini.
Mini handle.



4702

Bocca incasso vasca-doccia, con deviatore integrato, 15 cm.
Built-in spout for bath-shower, with integrated diverter, 15 cm.

MISCELATORI VASCA E DOCCIA - BATH & SHOWER MIXERS

**MT16617**

Miscelatore monocomando per lavello, con bocca alta a "U" girevole.
Altezza: 27 cm - Interasse: 22 cm.
Single-lever one-hole sink mixer, with high "U" movable spout.
Height: 27 cm - Interaxis: 22 cm.

**MT16614R**

Miscelatore monocomando per lavello, con bocca alta girevole, tipo lusso.
Altezza: 29 cm - Interasse: 19,5 cm.
Single-lever one-hole sink mixer, with high movable spout, luxury type.
Height: 29 cm - Interaxis: 19,5 cm.

**MT16614**

Miscelatore monocomando per lavello, con bocca alta fusa girevole.
Altezza: 25 cm - Interasse: 22 cm.
Single-lever one-hole sink mixer, with high movable casted spout.
Height: 25 cm - Interaxis: 22 cm.

**MT16614T**

Miscelatore lavello monoforo 45° con bocca alta girevole.
Altezza: 26,5 cm - Interasse: 19 cm.
Single-lever sink mixer 45° with high movable spout.
Height: 26,5 cm - Interaxis: 19 cm.

**MT16614C**

Miscelatore lavello monoforo 45° con canna fusa corta.
Altezza: 21 cm - Interasse: 12,5 cm.
Single-lever sink mixer 45° with short movable casted spout.
Height: 21 cm - Interaxis: 12,5 cm.

**MT16614TC**

Miscelatore lavello monoforo 45° con bocca corta girevole.
Altezza: 25 cm - Interasse: 12 cm.
Single-lever sink mixer 45° with short movable spout.
Height: 25 cm - Interaxis: 12 cm.

**MT16633**

Miscelatore monocomando per lavello a muro, con leva frontale e bocca girevole.
Altezza: 26 cm - Interasse: 19 cm.
Single-lever wall mounted sink mixer with frontal lever and movable spout.
Height: 26 cm - Interaxis: 19 cm.

**MT16609T**

Miscelatore lavello a muro con bocca girevole.
Lunghezza canna: 20 cm.
Wall-mounted single-lever sink mixer with movable spout.
Length spout: 20 cm.

**MT16609S**

Miscelatore lavello a muro con bocca ad "S" girevole.
Lunghezza canna: 20 cm.
Wall-mounted single-lever sink mixer with "S" movable spout.
Length spout: 20 cm.

**MT16609**

Miscelatore lavello a muro con canna fusa girevole.
Lunghezza canna: 20 cm.
Wall-mounted single-lever sink mixer with movable casted spout.
Length spout: 20 cm.

**MT16608**

Miscelatore monocomando per lavello, con bocca girevole.
Altezza: 16 cm - Interasse: 24 cm.
Single-lever one-hole sink mixer, with movable spout.
Height: 16 cm - Interaxis: 24 cm.

VENUS

RIO

SERENA

CONTRACT

ECO

LEVA
CLINICA

MINI

MINI
100



MINI 100

CARATTERISTICHE TECNICHE:
 La serie è dotata di cartuccia a dischi ceramici Ø35,
 prodotta da S.T.S.R. Studio Tecnico Sviluppo e
 Ricerche - www.stsr.it
INTERASSE CORPO: 100 mm.

TECHNICAL CHARACTERISTICS:
 The series is equipped with ceramic cartridge Ø35,
 produced by S.T.S.R. - Research Development
 Technical Office - www.stsr.it
BODY INTERAXIS: 100

MANIGLIE DISPONIBILI:
AVAILABLE HANDLES:



Maniglia M
M Lever



Maniglia MA
MA Lever



Maniglia MR
MR Lever



Maniglia MT
MT Lever



Maniglia MW
MW Lever

SHUT-OFF



MT22631ADP

Set composto da: doccia a pulsante,
 flessibile conico 120 cm, miscelatore
 doccia e supporto in ottone cromato.
*Set composed of: shut-off handshower,
 flexible 120 cm, shower mixer and c.p.
 brass shower holder.*



1031

Set "Oasis", composto da: doccia a
 pulsante, flessibile conico 120 cm,
 miscelatore doccia e supporto in
 ottone cromato.
*"Oasis" set composed of: shut-off
 handshower, flexible 120 cm, shower
 mixer and c.p. brass shower holder.*

MISCELATORI VASCA E DOCCIA - BATH & SHOWER MIXERS



Miscelatore vasca esterno.
Exposed bath/shower mixer.

MT22610 con flessibile cm 150 e doccetta.
with flexible cm 150 and handshower.

MT22600H senza kit doccia.
without shower kit.



Miscelatore monocomando esterno per doccia.
Lunghezza canna: 30 cm.
Wall mounted single-lever shower mixer.
Lenght spout: 30 cm.

MT22624 con flessibile cm 150 e doccetta.
with flexible cm 150 and handshower.

MT22624H senza kit doccia.
without shower kit.



Miscelatore lavabo/vasca con canna in tubo e deviatore.
Lunghezza canna: 40 cm.
Sink/bath mixer with tube spout, and diverter.
Lenght spout: 40 cm.

MT22623 con flessibile cm 150 e doccetta.
with flexible cm 150 and handshower.

MT22623H senza kit doccia.
without shower kit.



Miscelatore doccia.
Shower mixer.

MT22611A con flessibile cm 150 e doccetta.
with flexible cm 150 and handshower.

MT22611 senza kit doccia.
without shower kit.



Miscelatore monocomando esterno per doccia, con leva frontale.
Wall mounted single-lever shower mixer, with frontal lever.

MT22631A con flessibile cm 150 e doccetta.
with flexible cm 150 and handshower.

MT22631 senza kit doccia.
without shower kit.

VENUS

RIO

SERENA

CONTRACT

ECO

LEVA
CLINICA

MINI

MINI
100

CUCINA - KITCHEN



MT22609
Miscelatore monocomando per lavello a muro, con bocca girevole.
Lunghezza canna: 20 cm.
Single-lever wall mounted sink mixer, with movable spout.
Lenght spout: 20 cm.



MT22633
Miscelatore monocomando esterno per lavello, con leva frontale e bocca alta.
Altezza: 24 cm - Interasse: 19 cm.
Single-lever sink mixer, external mounted, with frontal lever and high spout.
Height: 24 cm - Interaxis: 19 cm.



X-FACTOR

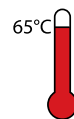
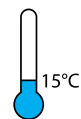
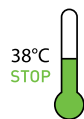

L'utilizzo dei modelli termostatici può aiutare ad avere un maggiore controllo sul consumo di acqua e energia, risparmiando la quantità di acqua solitamente sprecata cercando la temperatura desiderata.

The use of thermostatic models can help you to have more control over the energy and water consumption, saving the amount of water usually wasted looking for the desired temperature.

FINISHINGS

CP cromo spazzolato
brushed chrome

64 vecchio rame
old copper

DO oro lucido
shiny gold

GO grafite
graphite

PG oro rosa lucido
shiny pink gold

NP nichel spazzolato
brushed nickel

14 bianco opaco
matt white

DP oro spazzolato
brushed gold

PP oro rosa spazzolato
brushed pink gold

FIN 2

NPO nichel spazzolato opaco
matt brushed nickel

15 nero opaco
matt black

FZ cromo nero spazzolato lucido
shiny brushed black chrome

63 vecchio ottone
old brass

OIL oil bronze
oil bronze

FIN 4

CF cromo nero lucido
shiny black chrome

RL rame lucido
shiny copper

FIN 5

RPO rame anodizzato
anodised copper

Finiture consigliate per questa collezione.
Per l'elenco completo fare riferimento alla tabella delle finiture (pag.04)

*Suggested finishes for this collection.
For a complete list of available colors, please refer to the finishing table (page 04)*



TERMOSTATICI
THERMOSTATICSS

X-FACTOR

Q-FACTOR

SKYLINE
THERMO

SUVI
THERMO

OXY
THERMO

THERMO



X-FACTOR

CARATTERISTICHE TECNICHE:

La serie è dotata di cartuccia termostatica prodotta da S.T.S.R. Studio Tecnico Sviluppo e Ricerche - www.stsr.it

TECHNICAL CHARACTERISTICS:

The series is equipped with thermostatic cartridge, produced by S.T.S.R. Research Development Technical Office - www.stsr.it



Termostatico. L'utilizzo dei modelli termostatici può aiutare ad avere un maggiore controllo sul consumo di acqua ed energia.

Thermostatic. The use of thermostatic models can help you to have more control over the energy and water consumption.

MISCELATORI VASCA E DOCCIA - BATH & SHOWER MIXERS



Miscelatore termostatico esterno vasca.
Thermostatic bath mixer.

XF610 con flessibile cm 150 e doccetta.
with flexible cm 150 and handshower.

XF600H senza kit doccia.
without shower kit.



Miscelatore esterno doccia termostatico.
Thermostatic shower mixer.

XF611Z con attacco alto da 1/2" ed attacco inferiore da 1/2".
with upper 1/2" connection and lower 1/2" connection.

XF611Z34 con attacco alto da 3/4" ed attacco inferiore da 1/2".
with upper 3/4" connection and lower connection 1/2".



XF611 Miscelatore esterno doccia termostatico con attacco inferiore da 1/2".
Thermostatic shower mixer with lower 1/2" connection.

COLONNE DOCCIA - SHOWER COLUMN

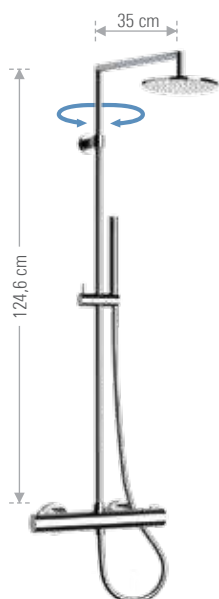

XF636N18 Set doccia composto da miscelatore termostatico esterno doccia con deviatore integrato, colonna doccia minimale Ø 18 mm, dado da 1/2", con saliscendi, doccetta anticalcare in ABS cromato, soffione in ABS cromato anticalcare Ø 25 cm. Flessibile 150 cm.
Shower set composed by external thermostatic shower single lever mixer with integrated diverter, minimal shower column Ø 18 mm, nut 1/2", with sliding central, anti-limestone handshower in ABS, showerhead in c.p. ABS Ø 25 cm with silicone jets anti-limestone. Shower flexible hose 150 cm.

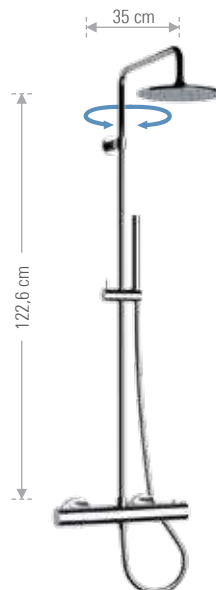

XF636U18 Set doccia composto da Miscelatore termostatico esterno doccia con deviatore integrato, colonna doccia deluxe Ø 18 mm, dado da 1/2", con saliscendi, doccetta anticalcare in ottone cromato e soffione in ABS cromato e anticalcare. Flessibile 150 cm.
Shower set composed by external thermostatic shower single lever mixer with integrated diverter, deluxe shower column Ø 18, nut 1/2", mm with sliding central, including anti-limestone handshower in c.p. brass and showerhead in c.p. ABS with anti-limestone silicone jets. Shower flexible hose 150 cm.



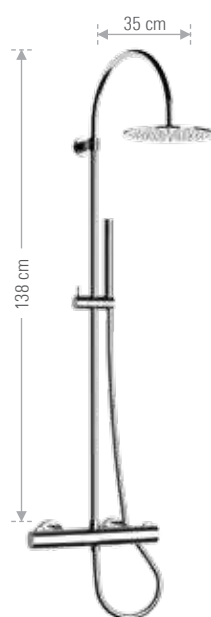
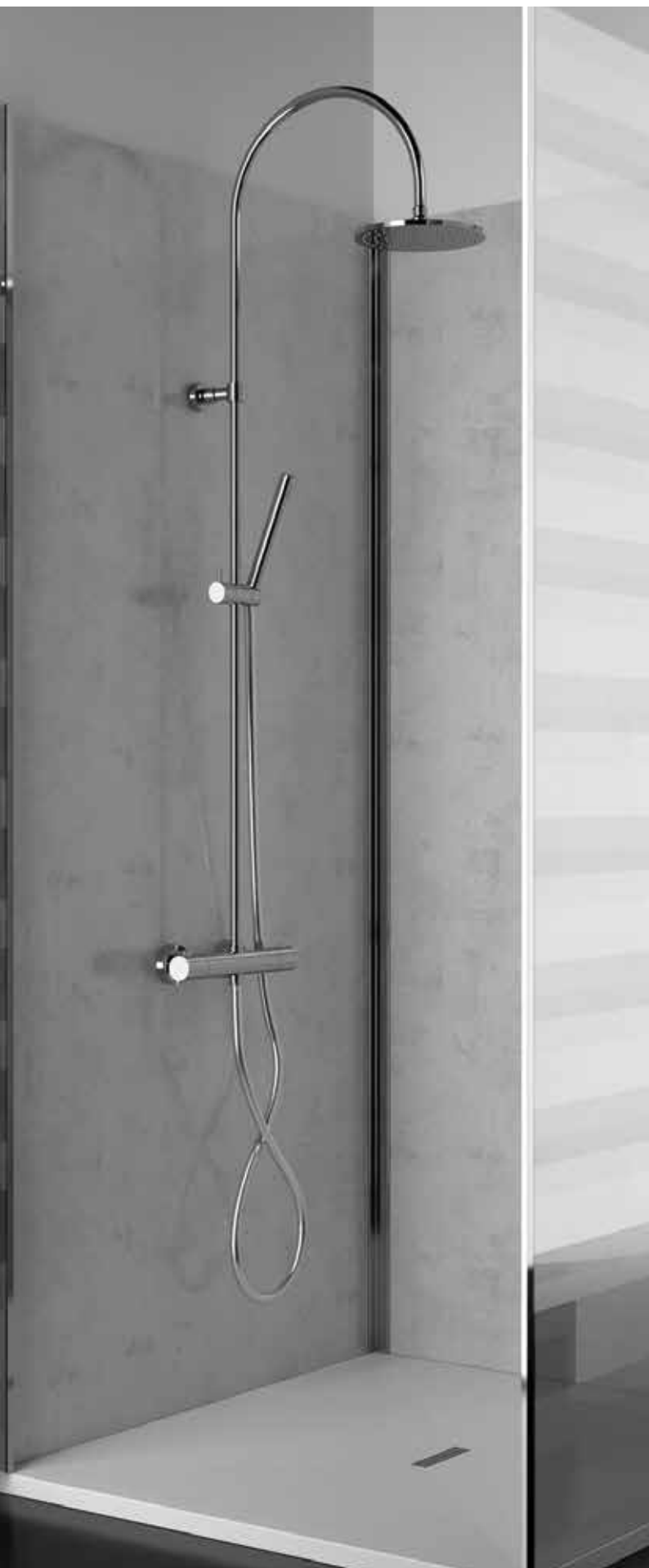

XF636L18

Set doccia composto da miscelatore termostatico esterno doccia con deviatore integrato, colonna doccia Ø 18 mm, dado da 1/2", con saliscendi, doccetta anticalcare in ottone cromato e soffione in ABS cromato e anticalcare Ø20 cm. Flessibile 150 cm.

Shower set composed by external thermostatic shower single lever mixer with integrated diverter, shower column Ø 18 mm, nut 1/2", with sliding central, including anti-limestone handshower in c.p. brass and showerhead in c.p. ABS 359 Ø20 cm with silicone jets anti-limestone. Shower flexible hose 150 cm.



X-FACTOR



XF636A3CP7725

Miscelatore doccia termostatico con attacco alto da 3-4" ed attacco inferiore da 1/2" con deviatore integrato, colonna doccia telescopica, doccetta anticalcare a 4 funzioni, con pulsante per il cambio dei getti e flessibile A505X 150 cm e soffione ultrapiatto 25x25 cm, in acciaio INOX lucidato a specchio.

Thermostatic shower mixer with upper 3/4" connection and lower connection 1/2" with integrated diverter, telescopic shower column, c.p. handshower 4 functions antilimestone with button to change jets, with A505X 150 cm flexible hose and ultra slim stainless steel mirror polished shower head 25x25 cm.



XF636A3MP8420

Miscelatore doccia termostatico con attacco alto da 3-4" ed attacco inferiore da 1/2" con deviatore integrato, colonna doccia telescopica, doccetta anticalcare a 4 funzioni, con pulsante per il cambio dei getti e flessibile A505X 150 cm e soffione lusso a pioggia, in ABS cromato, Ø 20 cm, con getti in silicone anticalcare.

Thermostatic shower mixer with upper 3/4" connection and lower connection 1/2" with integrated diverter, telescopic shower column, c.p. handshower 4 functions antilimestone with button to change jets, with A505X 150 cm flexible hose and c.p. deluxe ABS shower head, rain jet, Ø 20 cm, with anti-limestone silicon jets.

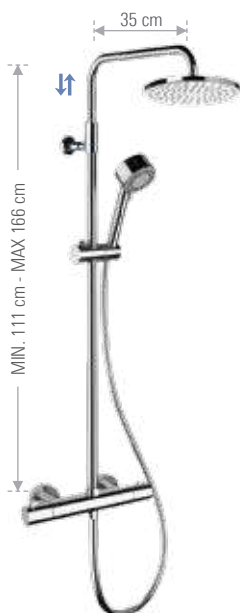

XF636A8420

Miscelatore doccia termostatico con attacco alto da 3-4" ed attacco inferiore da 1/2" con deviatore integrato, colonna doccia telescopica, doccetta anticalcare a 4 funzioni, con flessibile A505X 150 cm e soffione lusso a pioggia, in ABS cromato, Ø 20 cm, con getti in silicone anticalcare.

Thermostatic shower mixer with upper 3/4" connection and lower connection 1/2" with integrated diverter, telescopic shower column, c.p. handshower 4 functions antilimestone, with A505X 150 cm flexible hose and c.p. deluxe ABS shower head, rain jet, Ø 20 cm, with anti-limestone silicon jets.



XF636A3CPAD20

Miscelatore doccia termostatico con attacco alto da 3-4" ed attacco inferiore da 1/2" con deviatore integrato, colonna doccia telescopica, doccetta anticalcare a 4 funzioni, con pulsante per il cambio dei getti e flessibile A505X 150 cm e soffione a pioggia squadrato con angoli arrotondati, in ABS cromato, 20x20 cm, con getti in silicone anticalcare.

Thermostatic shower mixer with upper 3/4" connection and lower connection 1/2" with integrated diverter, telescopic shower column, c.p. handshower 4 functions antilimestone with button to change jets, with A505X 150 cm flexible hose and c.p. ABS squared with rounded corners shower head, rain jet, 20x20 cm, with anti-limestone silicon jets.





XF636A7820

Miscelatore doccia termostatico con attacco alto da 3-4" ed attacco inferiore da 1/2" con deviatore integrato, colonna doccia telescopica, doccetta anticalcare a 4 funzioni, con flessibile A505X 150 cm e soffione ultrapiatto Ø 20 cm, in acciaio INOX lucidato a specchio.
Thermostatic shower mixer with upper 3/4" connection and lower connection 1/2" with integrated diverter, telescopic shower column, c.p. handshower 4 functions antilimestone, with A505X 150 cm flexible hose and ultra slim stainless steel mirror polished shower head Ø 20 cm.

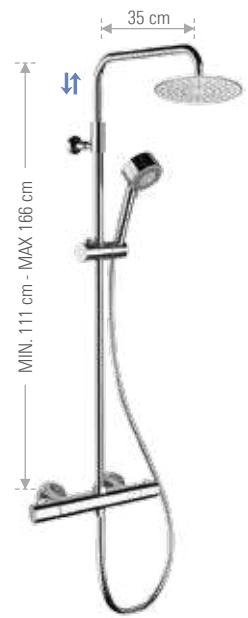

XF636AEC20

Miscelatore doccia termostatico con attacco alto da 3-4" ed attacco inferiore da 1/2" con deviatore integrato, colonna doccia telescopica, doccetta anticalcare a 4 funzioni, con flessibile A505X 150 cm e soffione a pioggia, in ABS cromato, Ø 20 cm, con getti in silicone anticalcare.
Thermostatic shower mixer with upper 3/4" connection and lower connection 1/2" with integrated diverter, telescopic shower column, c.p. handshower 4 functions antilimestone, with A505X 150 cm flexible hose and c.p. ABS shower head, rain jet, Ø 20 cm, with anti-limestone silicon jets.



XF636A3CP7720

Miscelatore doccia termostatico con attacco alto da 3-4" ed attacco inferiore da 1/2" con deviatore integrato, colonna doccia telescopica, doccetta anticalcare a 4 funzioni, con pulsante per il cambio dei getti e flessibile A505X 150 cm e soffione ultrapiatto 20x20 cm, in acciaio INOX lucidato a specchio.
Thermostatic shower mixer with upper 3/4" connection and lower connection 1/2" with integrated diverter, telescopic shower column, c.p. handshower 4 functions antilimestone with button to change jets, with A505X 150 cm flexible hose and ultra slim stainless steel mirror polished shower head 20x20 cm.



XF636A7825

Miscelatore doccia termostatico con attacco alto da 3-4" ed attacco inferiore da 1/2" con deviatore integrato, colonna doccia telescopica, doccetta anticalcare a 4 funzioni, con flessibile A505X 150 cm e soffione ultrapiatto Ø 25 cm, in acciaio INOX lucidato a specchio.
Thermostatic shower mixer with upper 3/4" connection and lower connection 1/2" with integrated diverter, telescopic shower column, c.p. handshower 4 functions antilimestone, with A505X 150 cm flexible hose and ultra slim stainless steel mirror polished shower head Ø 25 cm.

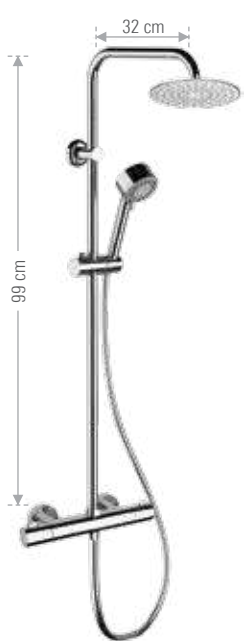

XF636XEC20

Miscelatore doccia termostatico con deviatore integrato, attacco alto da 3/4", attacco inferiore da 1/2", colonna doccia Minimale, doccetta anticalcare a 4 funzioni, con flessibile A505X 150 cm e soffione Ø 20 cm, in ABS cromato con getti in silicone autopulenti ed anticalcare.
Thermostatic shower mixer with integrated diverter, upper 3/4" connection, lower connection 1/2", Minimal shower column, c.p. handshower 4 functions antilimestone, with A505X 150 cm flexible hose and c.p. ABS shower head Ø 20 cm with selfcleaning and antilimestone silicon jets.



XF636X3CP7725

Miscelatore doccia termostatico con deviatore integrato, attacco alto da 3/4", attacco inferiore da 1/2", colonna doccia Minimale, doccetta anticalcare a 4 funzioni, con pulsante per il cambio dei getti e flessibile A505X 150 cm e soffione in acciaio INOX lucidato a specchio, 25x25 cm, con getti in silicone anticalcare.
Thermostatic shower mixer with integrated diverter, upper 3/4" connection and lower connection 1/2", Minimal shower column, c.p. handshower 4 functions antilimestone with button to change jets, with A505X 150 cm flexible hose and and stainless steel mirror polished squared with rounded corners shower head, 25x25 cm, with anti-limestone silicon jets.



X-FACTOR



XF636X3CPAD2

Miscelatore doccia termostatico con deviatore integrato, attacco alto da 3/4", attacco inferiore da 1/2", colonna doccia Minimale, doccetta anticalcare a 4 funzioni, con pulsante per il cambio dei getti e flessibile A505X 150 cm e soffione in ABS cromato con getti in silicone autopulenti ed anticalcare, 20x20 cm.

Thermostatic shower mixer with integrated diverter, upper 3/4" connection and lower connection 1/2", Minimal shower column, c.p. handshower 4 functions antilimestone with button to change jets, with A505X 150 cm flexible hose and c.p. ABS shower head 20x20 cm with selfcleaning and antilimestone silicon jets.

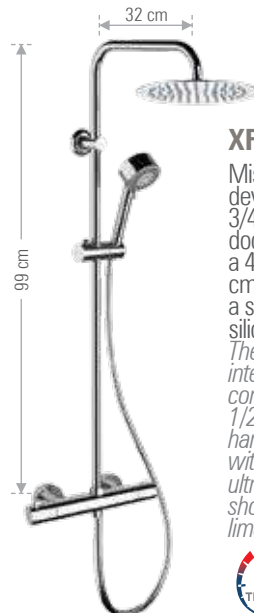

XF636X7825

Miscelatore doccia termostatico con deviatore integrato, attacco alto da 3/4", attacco inferiore da 1/2", colonna doccia Minimale, doccetta anticalcare a 4 funzioni, con flessibile A505X 150 cm e soffione in acciaio INOX lucidato a specchio, Ø 25 cm, con getti in silicone anticalcare.

Thermostatic shower mixer with integrated diverter, upper 3/4" connection and lower connection 1/2", Minimal shower column, c.p. handshower 4 functions antilimestone, with A505X 150 cm flexible hose and ultra slim stainless steel mirror polished shower head Ø 25 cm, with antilimestone silicon jets.

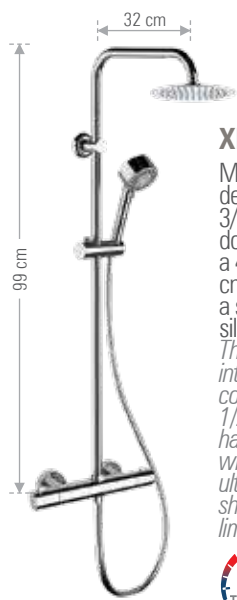

XF636X7820

Miscelatore doccia termostatico con deviatore integrato, attacco alto da 3/4", attacco inferiore da 1/2", colonna doccia Minimale, doccetta anticalcare a 4 funzioni, con flessibile A505X 150 cm e soffione in acciaio INOX lucidato a specchio, Ø 20 cm, con getti in silicone anticalcare.

Thermostatic shower mixer with integrated diverter, upper 3/4" connection and lower connection 1/2", Minimal shower column, c.p. handshower 4 functions antilimestone, with A505X 150 cm flexible hose and ultra slim stainless steel mirror polished shower head, Ø 20 cm, with antilimestone silicon jets.

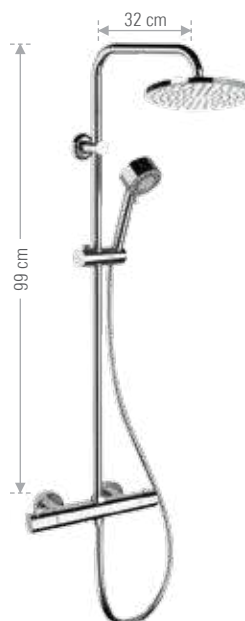

XF636X8420

Miscelatore doccia termostatico con deviatore integrato, attacco alto da 3/4", attacco inferiore da 1/2", colonna doccia Minimale, doccetta anticalcare a 4 funzioni, con flessibile A505X 150 cm e soffione ultrapiatto Ø 20 cm, in ABS cromato con getti in silicone autopulenti ed anticalcare.

Thermostatic shower mixer with integrated diverter, upper 3/4" connection and lower connection 1/2", Minimal shower column, c.p. handshower 4 functions antilimestone, with A505X 150 cm flexible hose and c.p. ABS shower head Ø 20 cm with selfcleaning and antilimestone silicon jets.





XF636X3CP7720

Miscelatore doccia termostatico con deviatore integrato, attacco alto da 3/4", attacco inferiore da 1/2", colonna doccia Minimale, doccetta anticalcare a 4 funzioni, con pulsante per il cambio dei getti e flessibile A505X 150 cm e soffione a pioggia squadrato con angoli arrotondati, in acciaio INOX lucidato a specchio, 20x20 cm, con getti in silicone anticalcare.

Thermostatic shower mixer with integrated diverter upper connection 3/4" and lower connection 1/2", Minimal shower column, c.p. handshower 4 functions antilimestone with button to change jets, with A505X 150 cm flexible hose and stainless steel mirror polished squared shower head, rain jet, 20x20 cm, with anti-limestone silicon jets.



TERMOSTATICI
THERMOSTICSS

X-FACTOR

Q-FACTOR

SKYLINE

THERMO

SUVI

THERMO

OXY

THERMO

THERMO



XF636U

Miscelatore doccia termostatico con deviatore integrato, attacco alto da 3/4", attacco inferiore da 1/2", colonna doccia Minimale, doccetta in ottone cromato ad 1 funzione, con flessibile in ottone cromato 150 cm e soffione in ottone Ø 20 cm con getti in silicone anticalcare.

Thermostatic shower mixer with integrated diverter, upper 3/4" connection and lower connection 1/2", minimal shower column, c.p. brass handshower 1 functions, with c.p. brass 150 cm flexible hose and c.p. brass shower head Ø 20 cm with anti-limestone silicon jets.



XF636X3MP8420

Miscelatore doccia termostatico con deviatore integrato, attacco alto da 3/4", attacco inferiore da 1/2", colonna doccia Minimale, doccetta anticalcare a 4 funzioni, con pulsante per il cambio dei getti e flessibile A505X 150 cm e soffione Ø 20 cm in ABS cromato con getti in silicone autopulenti ed anticalcare.

Thermostatic shower mixer with integrated diverter, upper 3/4" connection and lower connection 1/2", Minimal shower column, c.p. handshower 4 functions antilimestone with button to change jets, with A505X 150 cm flexible hose and c.p. ABS shower head Ø 20 cm with selfcleaning and antilimestone silicon jets.





Q-FACTOR

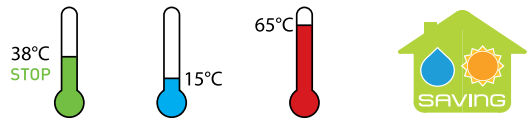

L'utilizzo dei modelli termostatici può aiutare ad avere un maggiore controllo sul consumo di acqua e energia, risparmiando la quantità di acqua solitamente sprecata cercando la temperatura desiderata.

The use of thermostatic models can help you to have more control over the energy and water consumption, saving the amount of water usually wasted looking for the desired temperature.

FINISHINGS

CP cromo spazzolato
brushed chrome

NP nichel spazzolato
brushed nickel

NPO nichel spazzolato opaco
matt brushed nickel

63 vecchio ottone
old brass

OIL oil bronze
oil bronze

64 vecchio rame
old copper

14 bianco opaco
matt white

15 nero opaco
matt black

FIN 2

FIN 4

DO oro lucido
shiny gold

DP oro spazzolato
brushed gold

FZ cromo nero spazzolato lucido
shiny brushed black chrome

CF cromo nero lucido
shiny black chrome

RL rame lucido
shiny copper

GO grafite
graphite

FIN 5

PG oro rosa lucido
shiny pink gold

PP oro rosa spazzolato
brushed pink gold

RPO rame anodizzato
anodised copper

Finiture consigliate per questa collezione.
Per l'elenco completo fare riferimento alla tabella delle finiture (pag.04)

*Suggested finishes for this collection.
For a complete list of available colors, please refer to the finishing table (page 04)*



TERMOSTATICI
THERMOSTATICSS

X-FACTOR

Q-FACTOR

SKYLINE
THERMO

SUVI
THERMO

OXY
THERMO

THERMO



CARATTERISTICHE TECNICHE:

La serie è dotata di cartuccia termostatica prodotta da S.T.S.R. Studio Tecnico Sviluppo e Ricerche - www.stsr.it

TECHNICAL CHARACTERISTICS:

The series is equipped with thermostatic cartridge, produced by S.T.S.R. Research Development Technical Office - www.stsr.it



Termostatico. L'utilizzo dei modelli termostatici può aiutare ad avere un maggiore controllo sul consumo di acqua ed energia.

Thermostatic. The use of thermostatic models can help you to have more control over the energy and water consumption.

MISCELATORI DOCCIA - SHOWER MIXERS



ZT611

Miscelatore esterno doccia termostatico, forma quadrata, con attacco inferiore da 1/2", maniglie in ABS cromato.

Thermostatic shower mixer, squared shape, with lower 1/2" connection, handles in chrome plated ABS.

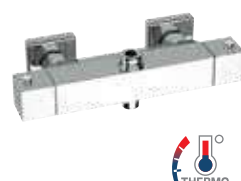

ZT611Z

Miscelatore esterno doccia termostatico, forma quadrata, con deviatore incorporato ed attacco alto da 3/4" ed attacco inferiore da 1/2", maniglie in ABS cromato.

Thermostatic shower mixer, squared shape, with integrated diverter, upper 3/4" connection and lower 1/2" connection, handles in chrome plated ABS.

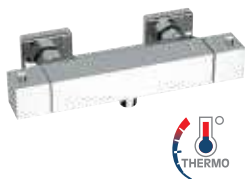

ZT611B

Miscelatore esterno doccia termostatico, forma quadrata, con attacco inferiore da 1/2", maniglie in ottone cromato.

Thermostatic shower mixer, squared shape, with lower 1/2" connection, handles in chrome plated brass.

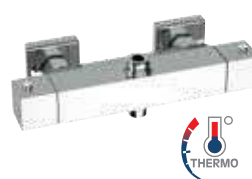

ZT611ZB

Miscelatore esterno doccia termostatico, forma quadrata, con deviatore incorporato ed attacco alto da 3/4" ed attacco inferiore da 1/2", maniglie in ottone cromato.

Thermostatic shower mixer, squared shape, with integrated diverter, upper 3/4" connection and lower 1/2" connection, handles in chrome plated brass.



ZT109

Kit doccia composto da miscelatore esterno doccia termostatico ZT611 saliscendi lusso ultrapiatto in ottone cromato A354, doccetta in ABS cromata A490 e flessibile A505X 150.

Shower kit composed of thermostatic shower mixer ZT611, ultraflat deluxe sliding rail in c.p. brass A354, handshower in c.p. ABS A490 and flexible hose A505X 150.



ZT109B

Kit doccia composto da miscelatore esterno doccia termostatico quadrato tipo lusso, con maniglie in ottone cromato ZT611B, saliscendi lusso ultrapiatto in ottone cromato A354, doccetta anticalcare con getti in silicone A492 e flessibile A505X 150.

Shower kit composed of thermostatic squared shower mixer luxury type, handles in chrome plated brass ZT611B, ultraflat deluxe sliding rail in c.p. brass A492, antilime showerhead with silicon jets 317SQ and flexible hose A505X 150.



COLONNE DOCCIA - SHOWER COLUMN

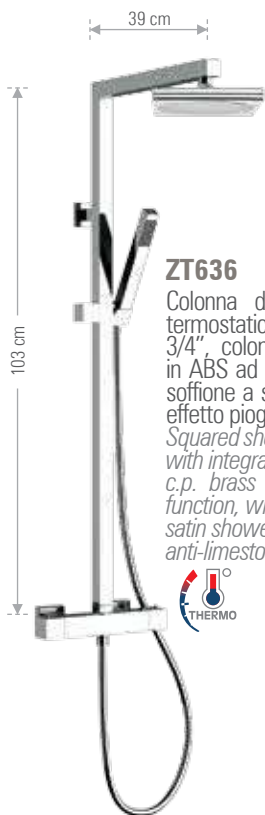

ZT636

Colonna doccia quadrata con miscelatore doccia termostatico con deviatore integrato, attacco alto da 3/4", colonna doccia in ottone cromato e doccetta in ABS ad 1 funzione, con flessibile A505X 150 cm e soffione a snodo, cromo-satinato 23x23 cm, con getti effetto pioggia in silicone, anticalcare.

Squared shower column with thermostatic shower mixer with integrated diverter and upper connection 3/4", with c.p. brass shower column, ABS c.p. handshower 1 function, with A505X 150 cm flexible hose and chrome-satin shower head, rain jet, 23x23 cm, with balljoint and anti-limestone silicon jets.



ZT636B

Colonna doccia quadrata con miscelatore doccia termostatico con deviatore integrato, attacco alto da 3/4", colonna doccia in ottone cromato e doccetta quadrata ad 1 funzione con getti in silicone, anticalcare, flessibile A505X 150 cm e soffione ultra piatto 20x20 cm in acciaio INOX lucidato a specchio, con getti effetto pioggia in silicone, anticalcare.

Squared shower column with thermostatic shower mixer with integrated diverter and upper connection 3/4", with c.p. brass shower column, squared handshower 1 function, anti-limestone with silicon jets, with A505X 150 cm flexible hose and ultra slim stainless steel mirror polished shower head 20x20 cm, with anti-limestone silicon jets.



X-FACTOR

Q-FACTOR

SKYLINE
THERMO

SUVI
THERMO

OXY
THERMO

THERMO



SKYLINE THERMO

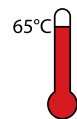
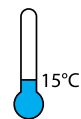
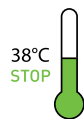

L'utilizzo dei modelli termostatici può aiutare ad avere un maggiore controllo sul consumo di acqua e energia, risparmiando la quantità di acqua solitamente sprecata cercando la temperatura desiderata.

The use of thermostatic models can help you to have more control over the energy and water consumption, saving the amount of water usually wasted looking for the desired temperature.





FINISHINGS

FIN 2

-  **CP** cromo spazzolato
brushed chrome
-  **NP** nichel spazzolato
brushed nickel
-  **NPO** nichel spazzolato opaco
matt brushed nickel
-  **63** vecchio ottone
old brass
-  **OIL** oil bronze
oil bronze
-  **64** vecchio rame
old copper
-  **14** bianco opaco
matt white
-  **15** nero opaco
matt black

FIN 4

-  **DO** oro lucido
shiny gold
-  **DP** oro spazzolato
brushed gold
-  **RL** rame lucido
shiny copper
-  **FZ** cromo nero spazzolato lucido
shiny brushed black chrome
-  **CF** cromo nero lucido
shiny black chrome
-  **GO** grafite
graphite

FIN 5

-  **PG** oro rosa lucido
shiny pink gold
-  **PP** oro rosa spazzolato
brushed pink gold
-  **RPO** rame anodizzato
anodised copper

Finiture consigliate per questa collezione.
Per l'elenco completo fare riferimento alla tabella delle finiture (pag.04)

Suggested finishes for this collection.
For a complete list of available colors, please refer to the finishing table (page 04)

DECORI DISPONIBILI:
AVAILABLE DECORATIONS:

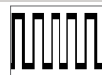

OPTICAL **YP**



DECO 1

-  **YP81** cromo lucido, decoro oro spazzolato.
shiny chrome, brushed gold decoration.

DECO 2

-  **YP84** nichel spazzolato, decoro cromo lucido.
brushed nickel, shiny chrome decoration.
-  **YP86** nichel spazzolato, decoro canna di fucile spazzolato.
brushed nickel, brushed gun barrel decoration..
-  **YP97** nichel spazzolato, decoro nichel lucido.
brushed nickel, shiny nickel decoration,

DECO 4

-  **YP85** nichel spazzolato, decoro oro spazzolato.
brushed nickel, brushed gold decoration.
-  **YP95** canna di fucile spazzolato, decoro cromo.
brushed gun barrel, chrome decoration.
-  **YP98** ottone spazzolato decoro ottone lucido.
brushed brass shiny brass decoration.

DECO 5

-  **YP82** oro lucido, decoro oro spazzolato.
shiny gold, brushed gold decoration.
-  **YP83** oro lucido, decoro nichel spazzolato.
shiny gold, brushed nickel decoration.
-  **YP88** oro antico, decoro canna di fucile spazzolato.
antique gold, brushed gun barrel decoration.
-  **YP96** oro spazzolato, decoro cromo.
brushed gold, chrome decoration.

DECO 6

-  **YP14** Bianco Opaco
Matt White
-  **YP15** Nero Opaco
Matt Black

DEKORA

SENSE

SKYLINE THERMO

CARATTERISTICHE TECNICHE:

La serie è dotata di cartuccia termostatica prodotta da S.T.S.R. Studio Tecnico Sviluppo e Ricerche - www.stsr.it

TECHNICAL CHARACTERISTICS:

The series is equipped with thermostatic cartridge, produced by S.T.S.R. Research Development Technical Office - www.stsr.it



Termostatico: l'utilizzo dei modelli termostatici può aiutare ad avere un maggiore controllo sul consumo di acqua ed energia.

Thermostatic: the use of thermostatic models can help you to have more control over the energy and water consumption.



Termostatico a corpo freddo: questa tecnologia fa sì che la superficie esterna del corpo del termostatico non si surriscaldi.

Cold body thermostatic: this technology prevents the outer surface of the thermostatic mixer body from overheating.

MISCELATORI DOCCIA TERMOSTATICI - THERMOSTATIC SHOWER MIXERS



Miscelatore termostatico esterno per doccia.
Thermostatic wall mounted shower mixer.

SKT611A con flessibile cm 150 e doccia.
with flexible cm 150 and handshower.

SKT611 senza kit doccia.
without shower kit.



SKT611ZV

Esterno doccia termostatico con attacco 3/4 M per colonna.

Thermostatic shower mixer with connection 3/4 M for columns.



SKT611Z

Esterno doccia termostatico con attacco 3/4 M per colonna.

Thermostatic shower mixer with connection 3/4 M for columns.



COLONNE DOCCIA - SHOWER COLUMN



SKT636QVB

Corpo doccia termostatico, colonna doccia quadrata, deviatore, doccia ad 1 funzione e soffione anticalcare quadrato 35x35 cm. Tutto in ottone cromato.

Thermostatic exposed shower mixer with squared shower column, diverter, 1 function handshower and antilime stone squared shower head 35x35 cm. All in c.p. brass.



SKT636QV

Corpo doccia termostatico, colonna doccia quadrata, deviatore, doccia ad 1 funzione e soffione anticalcare quadrato 20x20 cm. Tutto in ottone cromato.

Thermostatic exposed shower mixer with squared shower column, diverter, 1 function handshower and antilime stone squared shower head 20x20 cm. All in c.p. brass.





SKTF636QB

Corpo doccia termostatico con colonna quadrata, deviatore, doccetta ad 1 funzione e soffione anticalcare 35x35 cm. Tutto in ottone cromato.

Thermostatic exposed shower mixer with squared shower column, diverter, 1 function handshower and antilimestone shower head 35x35 cm. All in brass.



SKTF636Q

Corpo doccia termostatico con colonna, deviatore, doccetta ad 1 funzione e soffione anticalcare 20x20 cm. Tutto in ottone cromato.

Thermostatic exposed shower mixer with shower column, diverter, 1 function handshower and antilimestone shower head 20x20 cm. All in brass.



X-FACTOR

Q-FACTOR

SKYLINE

THERMO

MISCELATORI DOCCIA TERMOSTATICI A CORPO FREDDO - COLD BODY THERMOSTATIC SHOWER MIXERS

SUVI

THERMO



SKTF611Z

Gruppo doccia a muro termostatico corpo freddo, con attacco alto da 3/4".

Thermostatic cold body wall mounted shower mixer, with upper 3/4" connection.



SKTF611

Miscelatore termostatico corpo freddo esterno per doccia, con attacco inferiore da 1/2".

Thermostatic cold body wall mounted shower mixer with lower 1/2" connection.



OXY

THERMO

THERMO



SKTF611D

Miscelatore esterno doccia termostatico corpo freddo con attacco alto da 3/4" ed attacco inferiore da 1/2".

Cold body thermostatic shower mixer with upper 3/4" connection and lower 1/2" connection.



COLONNA DOCCIA TERMOSTATICI A CORPO FREDDO - COLD BODY THERMOSTATIC SHOWER COLUMN



SKTF636QB

Miscelatore termostatico esterno doccia a corpo freddo SKTF611D con colonna doccia quadra con saliscendi, doccetta ad 1 funzione completamente in ottone cromato e soffione anticalcare 35x35 cm.

Flessibile in ottone cromato incluso.

External cold body thermostatic shower single lever mixer SKTF611D with squared shower column with sliding central, including 1 function handshower and antilimestone showerhead all in c.p. brass 35x35 cm with silicone jets, anti-limestone.

Shower flexible in c.p. brass included.



INCASSI DOCCIA - BUILT IN SHOWER MIXER



SKT602

Miscelatore termostatico da incasso per doccia.
Thermostatic built-in mixer for shower.



SKT612

Miscelatore termostatico da incasso con deviatore per vasca-doccia.
Thermostatic built-in single-lever mixer, with diverter for bath-shower.



SKT612D2

Miscelatore termostatico per doccia con deviatore a 2 vie su piastra unica.
Thermostatic shower mixer, with 2 ways diverter on single flange.



SKT612D3

Miscelatore termostatico per doccia con deviatore a 3 vie e 3 posizioni (una entrata e tre uscite) su piastra unica.
Thermostatic built-in shower mixer with 3 ways diverter and 3 positions (1 inlet and 3 outlets) on single flange.



SKT612D4

Miscelatore termostatico per doccia, con deviatore a 4 vie (4 uscite ed 1 entrata) su piastra unica.
Thermostatic shower mixer with 4 ways diverter (4 outlets and 1 inlet) on single flange.



SKT612D5

Miscelatore termostatico per doccia, con deviatore a 5 vie (5 uscite ed una entrata) su piastra unica.
Thermostatic shower mixer with 5 ways diverter (5 outlets and 1 inlet) on single flange.



SKT612D7

Miscelatore termostatico per doccia con deviatore a 3 vie e 7 posizioni su unica piastra.
Thermostatic built-in shower mixer with 3 ways diverter with 7 positions on single flange.



BOX INCASSO - BUILT-IN BOX

SKT602KB

Set miscelatore doccia da abbinare al box incasso.
Shower mixer set to match with the built-in box.



DAN BOX

Box da incasso per miscelatore doccia con deviatore.
Built-in box for shower mixer with diverter.

X-FACTOR

SKT612KB

Set miscelatore doccia con deviatore da abbinare al box incasso.
Shower mixer set with diverter to match with the built-in box.

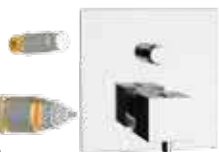

DAN BOX

Box da incasso per miscelatore doccia con deviatore.
Built-in box for shower mixer with diverter.

Q-FACTOR

SKYLINE

THERMO

SKT612D2KB

Set miscelatore doccia due vie da abbinare al box incasso.
Two ways shower mixer set to match with the built-in box.



DAN BOXD2

Box da incasso per miscelatore doccia due vie.
Built-in box for two ways shower mixer.

SUVI
THERMO

OXY
THERMO

THERMO

SKT612D3KB

Set miscelatore doccia tre vie da abbinare al box incasso.
Three ways shower mixer set to match with the built-in box.



DAN BOXD3

Box da incasso per miscelatore doccia tre vie.
Built-in box for three ways shower mixer.

SKT612D7KB

Set miscelatore doccia tre vie e sette posizioni da abbinare al box incasso.
Three ways and seven positions shower mixer set to match with the built-in box.



DAN BOXD3

Box da incasso per miscelatore doccia tre vie.
Built-in box for three ways shower mixer.

INCASSI DOCCIA - BUILT IN SHOWER MIXER



SKT620Z

con braccio a parete.
with wall mounted arm.



SKT620S

con braccio a soffitto.
with ceiling.



Set doccia termostatico composto da soffione anticalcare a pioggia rettangolare 24x14 cm con braccio 30 cm, doccetta ad 1 funzione con supporto doccia e flessibile conico 150 cm, bocca incasso con deviatore e miscelatore incasso termostatico con deviatore. Tutto in ottone cromato.

Thermostatic shower set composed of antilimestone rectangular shower head 24x14 cm with rain jet with arm 30 cm, hand shower 1 function c.p. shower holder with flexible hose 150 cm, built-in spout with diverter and thermostatic built-in mixer with diverter. All in c.p. brass.



SKT620ZSSCA



Set doccia termostatico con soffione doccia anticalcare a parete in acciaio INOX lucidato a specchio, doccetta ad 1 funzione con supporto doccia e flessibile conico 150 cm, bocca incasso con deviatore e miscelatore incasso. Tutto in ottone cromato.

Thermostatic shower set with antilimestone stainless steel mirror polished wall shower head, hand shower 1 function, shower holder with flexible hose 150 cm, built-in spout with diverter and thermostatic built-in mixer. All in c.p. brass.

con soffione A562CA a 2 getti, pioggia e cascata, e miscelatore incasso con deviatore a 3 vie e 7 posizioni su piastra unica SKT612D7.

with A562CA shower head, 2 jets rain and waterfall and built-in mixer with 3 ways diverter and 7 positions on single flange SKT612D7.

SKT620ZSS



con soffione A562 senza cascata, e miscelatore incasso con deviatore SKT612.

with A562 shower head with rainjet, without waterfall and built-in mixer with diverter SKT612.



SKT615Z

con braccio a parete.
with wall mounted arm.



SKT615S

con braccio a soffitto.
with ceiling.



Set doccia termostatico con soffione anticalcare a pioggia rettangolare 24x14 cm con braccio 30 cm, doccetta ad 1 funzione con supporto/presa acqua snodato lusso quadrato e flessibile conico 150 cm, miscelatore incasso termostatico con deviatore. Tutto in ottone cromato.

Thermostatic shower set with rectangular 24x14 cm antilimestone shower head rain jet with arm 30 cm, hand shower 1 function with shower holder/water punch connector squared and flexible hose 150 cm, thermostatic built-in bath/shower mixer with diverter. All in c.p. brass.



SKT615ZSSCA



Set doccia termostatico con soffione doccia anticalcare a parete in acciaio INOX lucidato a specchio, doccetta ad 1 funzione con supporto/presa acqua snodato lusso quadrato e flessibile conico 150 cm tutto in ottone cromato, miscelatore incasso con deviatore.

Thermostatic shower set with antilimestone stainless steel mirror polished wall shower head, hand shower 1 function with shower holder/water punch connector squared and flexible hose 150 cm all in c.p. brass, thermostatic built-in mixer with diverter.

con soffione A562CA a 2 getti, pioggia e cascata, e miscelatore incasso con deviatore a 3 vie e 7 posizioni su piastra unica SKT612D7.

with A562CA shower head with 2 jets rain and waterfall and built-in mixer with 3 ways diverter and 7 positions on single flange SKT612D7.

SKT615ZSS



con soffione A562 senza cascata, e miscelatore incasso con deviatore SKT612.

with A562 shower head with rain jet, without waterfall and built-in mixer with diverter SKT612.



SKT617Z

Set doccia termostatico con soffione anticalcare a pioggia rettangolare 24x14 cm con braccio 30 cm, doccetta ad 1 funzione con supporto/presa acqua snodato lusso quadrato, miscelatore termostatico e deviatore 3 vie e 7 posizioni, bocca incasso per miscelatore vasca-doccia. Tutto in ottone cromato.

Thermostatic shower set with antilimestone rectangular shower head with rain jet 24x14 cm with arm 30 cm, hand shower 1 function with shower holder/water punch connector squared, thermostatic shower mixer and 3 ways diverter and 7 positions, built-in spout. All in c.p. brass.



Set doccia termostatico con soffione anticalcare a pioggia rettangolare 24x14 cm con braccio 30 cm, saliscendi lusso con doccetta ad 1 funzione, attacco presa acqua tipo quadrato pesante, miscelatore incasso termostatico con deviatore. Tutto in ottone cromato.

Thermostatic shower set with antilimestone rectangular 24x14 cm shower head rain jet with arm cm 30, deluxe sliding rail with hand shower 1 function, wall water punch connector, squared and heavy type, thermostatic built-in bath/shower mixer with diverter. All in c.p. brass.

SKT614Z

con braccio a parete.
with wall mounted arm.



SKT614S

con braccio a soffitto.
with ceiling.



Set doccia termostatico con soffione doccia anticalcare a parete in acciaio INOX lucidato a specchio saliscendi lusso con doccetta ad 1 funzione e flessibile 150 cm tutto in ottone cromato, attacco presa acqua tipo quadrato pesante, miscelatore incasso termostatico con deviatore.

Thermostatic shower set with antilimestone stainless steel mirror polished wall shower head, deluxe sliding rail with 1 function hand shower and flexible hose 150 cm all in c.p. brass, wall water punch connector, squared and heavy type, thermostatic built-in bath/shower mixer.

con soffione A562CA a 2 getti, pioggia e cascata, e miscelatore incasso con deviatore a 3 vie e 7 posizioni su piastra unica SKT612D7.

SKT614ZSSCA

with A562CA shower head with 2 jets rain and waterfall and built-in mixer with 3 ways diverter and 7 positions on single flange SKT612D7.



SKT614ZSS

con soffione A562 senza cascata, e miscelatore incasso con deviatore SKT612.

with A562 shower head with rain jet, without waterfall and built-in mixer with diverter SKT612.



SKT613Z

Set doccia termostatico con soffione a pioggia anticalcare rettangolare 24x14 cm con braccio 30 cm, saliscendi lusso con doccetta ad 1 funzione, attacco presa acqua tipo quadrato pesante, miscelatore termostatico e deviatore 3 vie e 7 posizioni e 6 getti anticalcare. Tutto in ottone cromato.

Thermostatic shower set with antilimestone rectangular shower head with rain jet 24x14 cm, arm 30 cm, deluxe sliding rail with hand shower 1 function, water punch connector squared and heavy type, thermostatic shower mixer 3 ways diverter and 7 positions, 6 jets anti limestone. All in c.p. brass.



SKT616Z

Set doccia termostatico con soffione anticalcare a pioggia rettangolare 24x14 cm con braccio 30 cm, doccetta ad 1 funzione con supporto/presa acqua snodato lusso quadrato, miscelatore termostatico con deviatore 3 vie e 7 posizioni, 6 getti anticalcare. Tutto in ottone cromato.

Thermostatic shower set with antilimestone rectangular shower head rain jet 24x14 cm with arm 30 cm, hand shower 1 function with shower holder/water punch connector squared, thermostatic shower mixer 3 ways diverter and 7 positions, 6 jets anti limestone. All in c.p. brass.



SKT618Z

Set doccia termostatico con colonna doccia a barra quadrata, deluxe, con deviatore, presa acqua e centralina supporto doccetta, soffione doccia quadrato 20x20 cm con getti in silicone anticalcare, doccetta ad 1 funzione e flessibile conico 150 cm, presa acqua/attacco a muro quadrato, miscelatore incasso termostatico doccia. Tutto in ottone cromato.

Thermostatic shower set with squared bar deluxe shower column with diverter and wall connection, sliding part, squared shower head in brass with antilimestone silicone jets 20x20 cm, 1 function handshower with conical nut flexible hose 150 cm, and thermostatic built-in single-lever shower mixer. All in c.p. brass.



SKT614ZC

Set doccia termostatico con soffione doccia getto a cascata, saliscendi lusso con doccetta ad 1 funzione, attacco presa acqua tipo quadrato pesante, miscelatore incasso termostatico con deviatore. Tutto in ottone cromato.

Thermostatic shower set with waterfall shower head, deluxe sliding rail with hand shower 1 function, wall water punch connector squared and heavy type, thermostatic built-in bath/shower mixer with diverter. All in c.p. brass.



X-FACTOR

Q-FACTOR

SKYLINE

THERMO

SUVI

THERMO

OXY

THERMO

THERMO

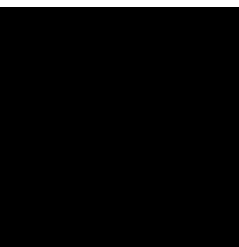

SUVI THERMO

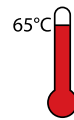
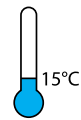
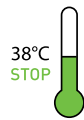

L'utilizzo dei modelli termostatici può aiutare ad avere un maggiore controllo sul consumo di acqua e energia, risparmiando la quantità di acqua solitamente sprecata cercando la temperatura desiderata.

The use of thermostatic models can help you to have more control over the energy and water consumption, saving the amount of water usually wasted looking for the desired temperature.





FINISHINGS

FIN 2

- | | | | | |
|--|---|---|---|---|
|  CP cromo spazzolato
brushed chrome |  NP nichel spazzolato
brushed nickel |  NPO nichel spazzolato opaco
matt brushed nickel |  63 vecchio ottone
old brass |  OIL oil bronze
oil bronze |
|  64 vecchio rame
old copper |  14 bianco opaco
matt white |  15 nero opaco
matt black | | |

FIN 4

- | | | | | | |
|--|--|---|--|---|---|
|  DO oro lucido
shiny gold |  DP oro spazzolato
brushed gold |  RL rame lucido
shiny copper |  FZ cromo nero spazzolato lucido
shiny brushed black chrome |  CF cromo nero lucido
shiny black chrome |  GO grafite
graphite |
|--|--|---|--|---|---|

FIN 5

- | | | |
|--|--|---|
|  PG oro rosa lucido
shiny pink gold |  PP oro rosa spazzolato
brushed pink gold |  RPO rame anodizzato
anodised copper |
|--|--|---|

Finiture consigliate per questa collezione.
Per l'elenco completo fare riferimento alla tabella delle finiture (pag.04)

*Suggested finishes for this collection.
For a complete list of available colors, please refer to the finishing table (page 04)*

DECORI DISPONIBILI:
AVAILABLE DECORATIONS:

SPIRAL YC



DECO 2

- | |
|--|
|  YC86 nichel spazzolato, decoro canna di fucile spazzolato.
brushed nickel, brushed gun barrel decoration.. |
|--|

- | |
|--|
|  YC97 nichel spazzolato, decoro nichel lucido.
brushed nickel, shiny nickel decoration, |
|--|

DECO 3

- | |
|---|
|  YC90 vecchio ottone decoro oro lucido.
old brass shiny gold decoration. |
|---|

DECO 4

- | |
|---|
|  YC85 nichel spazzolato, decoro oro spazzolato.
brushed nickel, brushed gold decoration. |
|---|

- | |
|---|
|  YC95 canna di fucile spazzolato, decoro cromo.
brushed gun barrel, chrome decoration. |
|---|

- | |
|--|
|  YC98 ottone spazzolato decoro ottone lucido.
brushed brass shiny brass decoration. |
|--|

DECO 5

- | |
|--|
|  YC88 oro antico, decoro canna di fucile spazzolato.
antique gold, brushed gun barrel decoration. |
|--|

- | |
|---|
|  YC96 oro spazzolato, decoro cromo.
brushed gold, chrome decoration. |
|---|

DECO 6

- | |
|--|
|  YC14 Bianco Opaco
Matt White |
|--|

- | |
|--|
|  YC15 Nero Opaco
Matt Black |
|--|

DEKORA

SENSE

SUVI THERMO

CARATTERISTICHE TECNICHE:

La serie è dotata di cartuccia termostatica prodotta da S.T.S.R. Studio Tecnico Sviluppo e Ricerche - www.stsr.it

TECHNICAL CHARACTERISTICS:

The series is equipped with thermostatic cartridge, produced by S.T.S.R. Research Development Technical Office - www.stsr.it



Termostatico: l'utilizzo dei modelli termostatici può aiutare ad avere un maggiore controllo sul consumo di acqua ed energia.

Thermostatic: the use of thermostatic models can help you to have more control over the energy and water consumption.



Termostatico a corpo freddo: questa tecnologia fa sì che la superficie esterna del corpo del termostatico non si surriscaldi.

Cold body thermostatic: this technology prevents the outer surface of the thermostatic mixer body from overheating.

MISCELATORI DOCCIA TERMOSTATICI - THERMOSTATIC SHOWER MIXERS



Miscelatore termostatico esterno doccia.
Thermostatic wall mounted shower mixer.

ST20611A con flessibile cm 150 e doccetta.
with flexible cm 150 and handshower.

ST20611 senza kit doccia.
without shower kit.



ST20611ZV

Esterno doccia termostatico con attacco 3/4 M per colonna.
Thermostatic shower mixer with connection 3/4 M for columns.



ST20611Z

Esterno doccia termostatico con attacco 3/4 M per colonna.
Thermostatic shower mixer with connection 3/4 M for columns.

COLONNE DOCCIA - SHOWER COLUMN

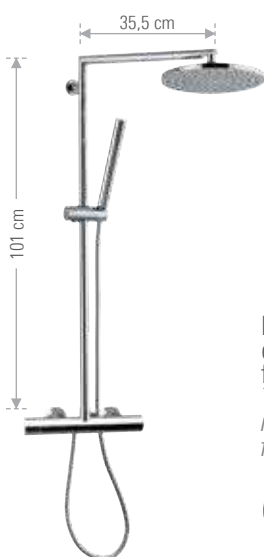

Miscelatore termostatico esterno doccia con colonna, deviatore, doccetta ad 1 funzione e soffione.
Thermostatic exposed single lever shower mixer with shower column, diverter, 1 function handshower and shower head.



ST20635 con soffione Ø20 cm.
with shower head Ø20 cm.

ST20635B con soffione Ø25 cm.
with shower head Ø25 cm.



Miscelatore termostatico esterno doccia con colonna, doccetta ad 1 funzione e soffione.
Thermostatic exposed single lever shower mixer with shower column, 1 function handshower and shower head.



ST20635V con soffione Ø20 cm.
with shower head Ø20 cm.

ST20635VB con soffione Ø25 cm.
with shower head Ø25 cm.

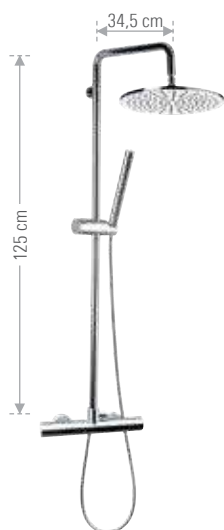

ST20636C

Miscelatore termostatico esterno doccia con colonna, deviatore, soffione Ø30 cm, doccetta ad 1 funzione. Tutto in ottone cromato.

Thermostatic exposed single lever shower mixer with shower column, diverter, shower head Ø30 cm, 1 function handshower. All in brass.

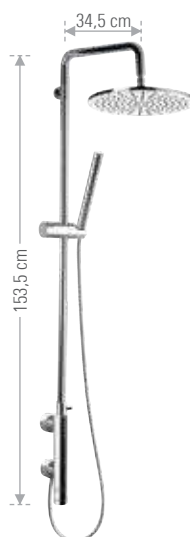

ST20636VC

Miscelatore termostatico esterno doccia con colonna, soffione Ø30 cm, doccetta ad 1 funzione. Tutto in ottone cromato.

Thermostatic exposed single lever shower mixer with shower column, shower head Ø30 cm, 1 function handshower. All in brass.



X-FACTOR

Q-FACTOR

SKYLINE

THERMO

MISCELATORI DOCCIA TERMOSTATICI A CORPO FREDDO - COLD BODY THERMOSTATIC SHOWER MIXERS

SUVI

THERMO



STF20611Z

Gruppo doccia a muro termostatico corpo freddo, con attacco alto da 3/4".

Thermostatic cold body wall mounted shower mixer, with upper 3/4" connection.



STF20611

Miscelatore termostatico corpo freddo esterno per doccia, con attacco inferiore da 1/2".

Thermostatic cold body wall mounted shower mixer with lower 1/2" connection.



OXY

THERMO

THERMO



STF20611D

Miscelatore esterno doccia termostatico corpo freddo con attacco alto da 3/4" ed attacco inferiore da 1/2" con deviatore integrato.

Cold body thermostatic shower mixer with upper 3/4" connection and lower 1/2" connection with integrated diverter.



COLONNA DOCCIA TERMOSTATICI A CORPO FREDDO - COLD BODY THERMOSTATIC SHOWER COLUMN

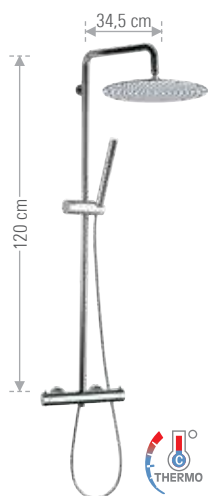

STF20636C

Miscelatore termostatico a corpo freddo esterno doccia STF20611D con deviatore integrato, colonna doccia deluxe con saliscendi, doccetta anticalcare in ottone cromato e soffione ultrapiatto in ottone cromato e anticalcare Ø 35 cm. Flessibile in ottone cromato 150 cm.

Cold body external thermostatic shower single lever mixer STF20611D with integrated diverter, deluxe shower column with sliding central, including antilimestone handshower in c.p. brass and ultrathin showerhead in c.p. brass Ø 35 cm with silicone jets, antilimestone. Shower flexible in c.p. brass 150 cm.



SHUT-OFF



ST206424DC

Miscelatore incasso termostatico per shut-off con doccetta shut-off, supporto doccia, presa acqua.
Thermostatic built-in shut-off mixer set with shut-off, hand shower, shower holder/water punch.



INCASSI DOCCIA - BUILT IN SHOWER MIXER



ST20602

Miscelatore termostatico da incasso per doccia.
Thermostatic built-in mixer for shower.



ST20612

Miscelatore termostatico da incasso con deviatore per vasca-doccia.
Thermostatic built-in single-lever mixer, with diverter for bath-shower.



ST20612D2

Miscelatore termostatico per doccia con deviatore a 2 vie su piastra unica.
Thermostatic shower mixer, with 2 ways diverter on single flange.



ST20612D3

Miscelatore termostatico per doccia con deviatore a 3 vie e 3 posizioni (una entrata e tre uscite) su piastra unica.
Thermostatic built-in shower mixer with 3 ways diverter and 3 positions (1 inlet and 3 outlets) on single flange.



ST20612D4

Miscelatore termostatico per doccia, con deviatore a 4 vie (4 uscite ed 1 entrata) su piastra unica.
Thermostatic shower mixer with 4 ways diverter (4 outlets and 1 inlet) on single flange.



ST20612D5

Miscelatore termostatico per doccia, con deviatore a 5 vie (5 uscite ed una entrata) su piastra unica.
Thermostatic shower mixer with 5 ways diverter (5 outlets and 1 inlet) on single flange.



ST20612D7

Miscelatore termostatico per doccia con deviatore a tre vie e sette posizioni su unica piastra.
Thermostatic built-in shower mixer with three ways diverter with seven positions on single flange.



BOX INCASSO - BUILT-IN BOX

ST20602KB

Set miscelatore doccia da abbinare al box incasso.
Shower mixer set to match with the built-in box.



DAN BOX

Box da incasso per miscelatore doccia con deviatore.
Built-in box for shower mixer with diverter.

X-FACTOR

ST20612KB

Set miscelatore doccia con deviatore da abbinare al box incasso.
Shower mixer set with diverter to match with the built-in box.

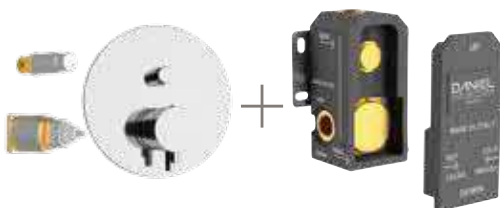

DAN BOX

Box da incasso per miscelatore doccia con deviatore.
Built-in box for shower mixer with diverter.

SKYLINE

THERMO

SUVI

THERMO

ST20612D2KB

Set miscelatore doccia due vie da abbinare al box incasso.
Two ways shower mixer set to match with the built-in box.

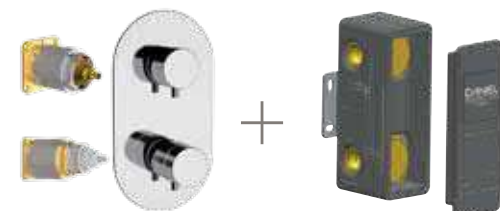

DAN BOXD2

Box da incasso per miscelatore doccia due vie.
Built-in box for two ways shower mixer.

OXY

THERMO

ST20612D3KB

Set miscelatore doccia tre vie da abbinare al box incasso.
Three ways shower mixer set to match with the built-in box.



DAN BOXD3

Box da incasso per miscelatore doccia tre vie.
Built-in box for three ways shower mixer.

THERMO

ST20612D7KB

Set miscelatore doccia tre vie e sette posizioni da abbinare al box incasso.
Three ways and seven positions shower mixer set to match with the built-in box.



DAN BOXD3

Box da incasso per miscelatore doccia tre vie.
Built-in box for three ways shower mixer.



Set doccia con soffione anticalcare Ø20 cm e braccio 30 cm, miscelatore termostatico con deviatore 2 vie, doccetta ad 1 funzione con supporto lusso e flessibile conico 150 cm, bocca incasso con deviatore. Tutto in ottone cromato.

Shower set composed of shower head Ø20 cm with arm 30 cm, 1 function handshower with shower holder and conical flexible hose 150 cm, thermostatic shower mixer 2 ways diverter and built-in spout with diverter. All in c.p. brass.

ST20620Z con braccio a parete.
with wall mounted arm.



ST20620S con braccio a soffitto.
with ceiling.



Set doccia con soffione anticalcare Ø20 cm e braccio 30 cm, miscelatore termostatico con deviatore 2 vie, doccetta ad 1 funzione con supporto presa acqua lusso. Tutto in ottone cromato.

Shower set composed of shower head Ø20 cm with arm 30 cm, thermostatic shower mixer 2 ways diverter, hand shower with shower holder/water punch. All in c.p. brass.

ST20615Z con braccio a parete.
with wall mounted arm.



ST20615S con braccio a soffitto.
with ceiling.



Set doccia con soffione doccia ultrapiatto a parete in acciaio INOX lucidato a specchio, miscelatore termostatico con deviatore, doccetta e supporto lusso per incasso, bocca incasso. Tutto in ottone cromato.
Shower set with ultra slim stainless steel mirror polished wall shower head, hand shower with shower holder, thermostatic shower mixer with diverter. All in c.p. brass.

ST20620ZSSCA

con soffione A564CA a 2 getti, pioggia e cascata, e miscelatore incasso con deviatore a 3 vie e 7 posizioni su piastra unica ST20612D7.



with A564CA shower head with 2 jets rain and waterfall and built-in mixer with 3 ways diverter with 7 positions on single flange ST20612D7.

ST20620ZSS

con soffione A564 getto pioggia senza cascata, e miscelatore incasso con deviatore ST20612.



with A564 shower head with rain jet without waterfall and built-in mixer with diverter ST20612.



Set doccia con soffione doccia anticalcare ultrapiatto a parete in acciaio INOX lucidato a specchio, miscelatore termostatico con deviatore 2 vie, doccetta ad 1 funzione con supporto presa acqua lusso. Tutto in ottone cromato.

Shower set with antilimestone ultra slim stainless steel mirror polished wall shower head, thermostatic shower mixer 2 ways diverter, hand shower with shower holder/water punch. All in c.p. brass.

ST20615ZSSCA

con soffione A564CA a 2 getti, pioggia e cascata, e miscelatore incasso con deviatore a 3 vie e 7 posizioni su piastra unica ST20612D7.



with A564CA shower head with 2 jets rain and waterfall and built-in mixer with 3 ways diverter with 7 positions on single flange ST20612D7.

ST20615ZSS

con soffione A564 getto pioggia senza cascata, e miscelatore incasso con deviatore ST20612.



with A564 shower head with rain jet without waterfall and built-in mixer with diverter ST20612.



Set doccia con soffione minimale anticalcare Ø20 cm con braccio 30 cm, miscelatore termostatico vasca/doccia incasso con deviatore, saliscendi minimale con doccetta ad 1 funzione e flessibile conico 150 cm, attacco presa acqua da 1/2 tipo rotondo pesante. Tutto in ottone cromato.

Shower set with antilimestone minimal shower head Ø20 cm with arm 30 cm, thermostatic built-in bath mixer with diverter, sliding rail minimal with 1 function handshower and conical flexible hose 150 cm, wall water punch connector round heavy type. All in c.p. brass.

ST20614Z con braccio a parete.
with wall mounted arm.



ST20614S con braccio a soffitto.
with ceiling.



Set doccia con soffione doccia anticalcare ultrapiatto a parete in acciaio INOX lucidato a specchio, miscelatore termostatico con deviatore, saliscendi minimale con doccetta ad 1 funzione e flessibile conico 150 cm, attacco presa acqua da 1/2 tipo rotondo pesante. Tutto in ottone cromato.

Shower set with antilimestone ultra slim stainless steel mirror polished wall shower head, thermostatic shower mixer with diverter, sliding rail with 1 function handshower and conical flexible hose 150 cm, wall water punch connector round heavy type. All in c.p. brass.

con soffione A564CA a 2 getti, pioggia e cascata, e miscelatore incasso con deviatore a 3 vie e 7 posizioni su piastra unica ST20612D7.

ST20614ZSSCA



with A564CA shower head with 2 jets rain and waterfall and built-in mixer with 3 ways diverter with 7 positions on single flange ST20612D7.

ST20614ZSS



con soffione A564 getto pioggia senza cascata, e miscelatore incasso con deviatore ST20612.

with A564 shower head with rain jet without waterfall and built-in mixer with diverter ST20612.



ST20617Z

Set doccia composto da soffione anticalcare Ø 20 cm con braccio 30 cm, miscelatore termostatico e deviatore 3 vie e 7 posizioni, doccetta ad 1 funzione con supporto presa acqua lusso per incasso, bocca incasso. Tutto in ottone cromato.

Shower set composed of antilimestone shower head Ø20 cm with arm 30 cm, hand shower with shower holder/water punch, thermostatic shower mixer 3 ways diverter and 7 positions and built-in spout. All in c.p. brass.



ST20615ZC

Set doccia composto da soffione a cascata, miscelatore vasca incasso termostatico con deviatore, doccetta ad 1 funzione con supporto presa acqua lusso per incasso. Tutto in ottone cromato.

Shower set composed of waterfall shower head, thermostatic built-in bath mixer with diverter, 1 function hand shower with shower holder/water punch. All in c.p. brass.



X-FACTOR

Q-FACTOR

SKYLINE
THERMO

SUVI
THERMO

OXY
THERMO

THERMO



ST20613Z

Set doccia composto da soffione minimale anticalcare Ø20 cm con braccio 30 cm, saliscendi minimale con doccetta ad 1 funzione, attacco presa acqua 1/2 tipo rotondo pesante, miscelatore termostatico e deviatore 3 vie e 7 posizioni e 6 getti anticalcare. Tutto in ottone cromato.

Shower set composed of antilimestone minimal shower head Ø20 cm with arm 30 cm, minimal sliding rail with hand shower 1 function, wall water punch connector, squared and heavy type, thermostatic shower mixer and 3 ways diverter and 7 positions and 6 jets anti limestone. All in c.p. brass.



ST20616Z

Set doccia composto da soffione minimale anticalcare Ø 20 cm con braccio in ottone 30 cm, doccia con supporto presa acqua lusso per incasso, 6 getti anticalcare e miscelatore termostatico con deviatore 3 vie e 7 posizioni. Tutto in ottone cromato.

Shower set composed of antilimestone shower head Ø20 cm with arm 30 cm, 1 function hand shower with shower holder/water punch, 6 jets antilimestone, thermostatic shower mixer 3 ways diverter and 7 positions. All in c.p. brass.

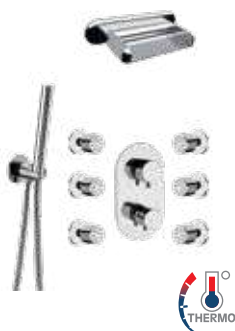

ST20616ZC

Set doccia composto da soffione a cascata, doccetta ad 1 funzione con supporto presa acqua lusso per incasso, 6 getti anticalcare e miscelatore con deviatore termostatico 3 vie e 7 posizioni. Tutto in ottone cromato.

Shower set composed of waterfall shower head, 1 function hand shower with shower holder/water punch, 6 jets antilimestone and thermostatic shower mixer 3 ways diverter and 7 positions. All in c.p. brass.



ST20619Z

Set doccia composto da colonna doccia con deviatore, presa acqua e centralina supporto doccetta, soffione anticalcare Ø20 cm, doccetta ad 1 funzione, miscelatore vasca/doccia incasso termostatico con deviatore, bocca incasso. Tutto in ottone cromato.

Shower set composed of shower column with diverter and wall connection, sliding part, antilimestone shower head Ø20 cm, 1 function handshower, thermostatic built-in bath mixer with diverter, built-in spout. All in c.p. brass.





TERMOSTATICI
TERMOSTATICSS

X-FACTOR

Q-FACTOR

SKYLINE
THERMO

SUVI
THERMO

OXY
THERMO

THERMO

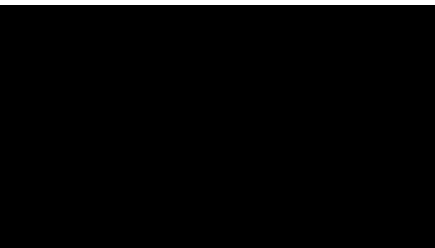
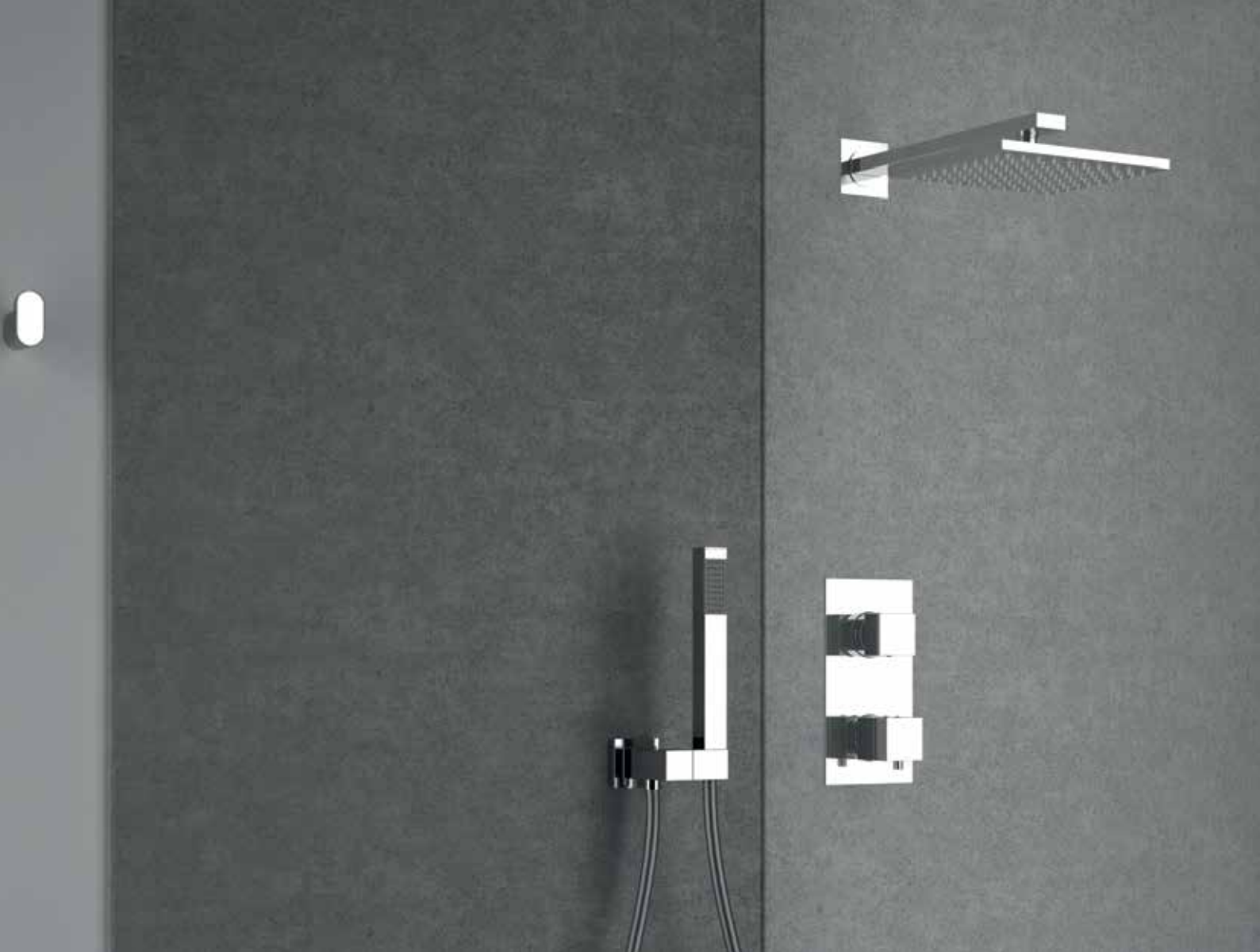

OXY THERMO

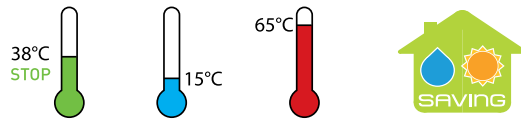

L'utilizzo dei modelli termostatici può aiutare ad avere un maggiore controllo sul consumo di acqua e energia, risparmiando la quantità di acqua solitamente sprecata cercando la temperatura desiderata.

The use of thermostatic models can help you to have more control over the energy and water consumption, saving the amount of water usually wasted looking for the desired temperature.





FINISHINGS

- | | | | | |
|--|---|---|---------------------------------------|-------------------------------------|
| CP cromo spazzolato
brushed chrome | NP nichel spazzolato
brushed nickel | NPO nichel spazzolato opaco
matt brushed nickel | 63 vecchio ottone
old brass | OIL oil bronze
oil bronze |
| 64 vecchio rame
old copper | 14 bianco opaco
matt white | 15 nero opaco
matt black | | |
- | | | | | | |
|------------------------------------|--|---------------------------------------|--|---|-------------------------------|
| FIN 4 | | | | | |
| DO oro lucido
shiny gold | DP oro spazzolato
brushed gold | RL rame lucido
shiny copper | FZ cromo nero spazzolato lucido
shiny brushed black chrome | CF cromo nero lucido
shiny black chrome | GO grafite
graphite |
- | | | |
|--|--|---|
| FIN 5 | | |
| PG oro rosa lucido
shiny pink gold | PP oro rosa spazzolato
brushed pink gold | RPO rame anodizzato
anodised copper |

Finiture consigliate per questa collezione.
Per l'elenco completo fare riferimento alla tabella delle finiture (pag.04)

*Suggested finishes for this collection.
For a complete list of available colors, please refer to the finishing table (page 04)*

DECORI DISPONIBILI:
AVAILABLE DECORATIONS: POP ART YL



DEKORA

- | | | |
|---|---|--|
| DECO 1 | | |
| YL80 cromo lucido, decoro nichel spazzolato.
shiny chrome, brushed nickel decoration. | YL81 cromo lucido, decoro oro spazzolato.
shiny chrome, brushed gold decoration | |
| DECO 2 | | |
| YL84 nichel spazzolato, decoro cromo lucido.
brushed nickel, shiny chrome decoration. | YL86 nichel spazzolato, decoro canna di fucile spazzolato.
brushed nickel, brushed gun barrel decoration. | YL97 nichel spazzolato, decoro nichel lucido.
brushed nickel, shiny nickel decoration, |
| DECO 4 | | |
| YL85 nichel spazzolato, decoro oro spazzolato.
brushed nickel, brushed gold decoration. | YL95 canna di fucile spazzolato, decoro cromo.
brushed gun barrel, chrome decoration. | YL98 ottone spazzolato decoro ottone lucido.
brushed brass shiny brass decoration. |
| DECO 5 | | |
| YL82 oro lucido, decoro oro spazzolato.
shiny gold, brushed gold decoration. | YL83 oro lucido, decoro nichel spazzolato.
shiny gold, brushed nickel decoration. | YL88 oro antico, decoro canna di fucile spazzolato.
antique gold, brushed gun barrel decoration. |
| YL96 oro spazzolato, decoro cromo.
brushed gold, chrome decoration. | | |
| DECO 6 | | |
| YL14 Bianco Opaco
Matt White | YL15 Nero Opaco
Matt Black | |

SENSE

CARATTERISTICHE TECNICHE:

La serie è dotata di cartuccia termostatica prodotta da S.T.S.R. Studio Tecnico Sviluppo e Ricerche - www.stsr.it

TECHNICAL CHARACTERISTICS:

The series is equipped with thermostatic cartridge, produced by S.T.S.R. Research Development Technical Office - www.stsr.it

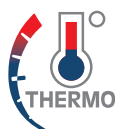

Termostatico. L'utilizzo dei modelli termostatici può aiutare ad avere un maggiore controllo sul consumo di acqua ed energia.

Thermostatic. The use of thermostatic models can help you to have more control over the energy and water consumption.

INCASSI DOCCIA - BUILT IN SHOWER MIXER



SKT602

Miscelatore termostatico da incasso per doccia.
Thermostatic built-in mixer for shower.



SKT612

Miscelatore termostatico da incasso con deviatore per vasca-doccia.
Thermostatic built-in single-lever mixer, with diverter for bath-shower.



SKT612D2

Miscelatore termostatico per doccia con deviatore a 2 vie su piastra unica.
Thermostatic shower mixer, with 2 ways diverter on single flange.



SKT612D3

Miscelatore termostatico per doccia con deviatore a 3 vie e 3 posizioni (una entrata e tre uscite) su piastra unica.
Thermostatic built-in shower mixer with 3 ways diverter and 3 positions (1 inlet and 3 outlets) on single flange.



SKT612D4

Miscelatore termostatico per doccia, con deviatore a 4 vie (4 uscite ed 1 entrata) su piastra unica.
Thermostatic shower mixer with 4 ways diverter (4 outlets and 1 inlet) on single flange.



SKT612D5

Miscelatore termostatico per doccia, con deviatore a 5 vie (5 uscite ed una entrata) su piastra unica.
Thermostatic shower mixer with 5 ways diverter (5 outlets and 1 inlet) on single flange.



SKT612D7

Miscelatore termostatico per doccia con deviatore a tre vie e sette posizioni su unica piastra.
Thermostatic built-in shower mixer with three ways diverter with seven positions on single flange.



BOX INCASSO - BUILT-IN BOX

SKT602KB

Set miscelatore doccia da abbinare al box incasso.
Shower mixer set to match with the built-in box.



DAN BOX

Box da incasso per miscelatore doccia con deviatore.
Built-in box for shower mixer with diverter.

X-FACTOR

SKT612KB

Set miscelatore doccia con deviatore da abbinare al box incasso.
Shower mixer set with diverter to match with the built-in box.

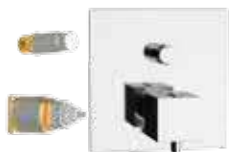

DAN BOX

Box da incasso per miscelatore doccia con deviatore.
Built-in box for shower mixer with diverter.

SKYLINE

THERMO

SUVI

THERMO

SKT612D2KB

Set miscelatore doccia due vie da abbinare al box incasso.
Two ways shower mixer set to match with the built-in box.



DAN BOXD2

Box da incasso per miscelatore doccia due vie.
Built-in box for two ways shower mixer.

THERMO

SKT612D3KB

Set miscelatore doccia tre vie da abbinare al box incasso.
Three ways shower mixer set to match with the built-in box.



DAN BOXD3

Box da incasso per miscelatore doccia tre vie.
Built-in box for three ways shower mixer.

SKT612D7KB

Set miscelatore doccia tre vie e sette posizioni da abbinare al box incasso.
Three ways and seven positions shower mixer set to match with the built-in box.



DAN BOXD3

Box da incasso per miscelatore doccia tre vie.
Built-in box for three ways shower mixer.

OXY

THERMO

OXT23613Z

Set doccia con soffione anticalcare a pioggia quadrato 20x20 cm con braccio 30 cm, saliscendi lusso con doccetta ad 1 funzione, attacco presa acqua tipo quadrato pesante, miscelatore termostatico con deviatore a 3 vie e 7 posizioni e 6 getti anticalcare. Tutto in ottone cromato.

Shower set with antilimestone squared shower head 20x20 cm rain jet with arm 30 cm, deluxe sliding rail with hand shower 1 function, wall water punch connector, squared and heavy type, thermostatic shower mixer with 3 ways diverter and 7 positions and 6 jets anti limestone. All in c.p. brass.



OXT23616Z

Set doccia con soffione quadrato anticalcare a pioggia 20x20 cm con braccio 30 cm, doccetta ad 1 funzione con supporto/presa acqua snodato lusso quadrato, miscelatore termostatico con deviatore a 3 vie e 7 posizioni e 6 getti anticalcare. Tutto in ottone cromato.

Shower set with antilimestone squared shower head rain jet 20x20 cm with arm 30 cm, hand shower 1 function with shower holder/water punch connector squared, thermostatic shower mixer 3 ways diverter and 7 positions, 6 jets anti limestone. All in c.p. brass.





OXT23614Z

Set doccia con soffione anticalcare a pioggia quadrato 20x20 cm con braccio 30 cm, saliscendi lusso con doccetta ad 1 funzione, attacco presa acqua tipo quadrato pesante, miscelatore incasso termostatico con deviatore. Tutto in ottone cromato.

Shower set with squared shower head rain jet 20x20 cm with arm 30 cm, deluxe sliding rail with hand shower 1 function, wall water punch connector squared and heavy type, with thermostatic built-in bath/shower mixer with diverter. All in c.p. brass.



OXT23615Z

Set doccia con soffione a pioggia quadrato 20x20 cm con braccio 30 cm, doccetta ad 1 funzione con supporto/presa acqua snodato lusso quadrato, miscelatore incasso termostatico con deviatore. Tutto in ottone cromato.

Shower set with squared shower head rain jet 20x20 cm with arm 30 cm, hand shower 1 function with shower holder/water punch connector squared, thermostatic built-in bath/shower mixer with diverter. All in c.p. brass.



X-FACTOR

Q-FACTOR

SKYLINE

THERMO

SUVI

THERMO

OXY

THERMO

THERMO



OXT23617Z

Set doccia con soffione a pioggia quadrato 20x20 cm con braccio 30 cm, doccetta ad 1 funzione con supporto/presa acqua snodato lusso quadrato, con miscelatore termostatico con deviatore a 3 vie e 7 posizioni e bocca. Tutto in ottone cromato.

Shower set with squared shower head rain jet 20x20 cm with arm 30 cm, hand shower 1 function with shower holder/water punch connector squared, thermostatic shower mixer 3 ways diverter and 7 positions, built-in spout. All in c.p. brass.



OXT23619Z

Set doccia con colonna doccia con deviatore, presa acqua e centralina supporto doccetta, soffione anticalcare e getto pioggia quadrato 20x20 cm, doccetta ad 1 funzione, miscelatore incasso termostatico con deviatore, bocca incasso. Tutto in ottone cromato.

Shower set composed of shower column with diverter, wall connection and sliding part, antilimestone squared shower head with rain jet 20x20 cm, 1 function hand shower, thermostatic built-in bath/shower mixer with diverter, built-in spout. All in c.p. brass.





THERMO

CARATTERISTICHE TECNICHE:

La serie è dotata di cartuccia termostatica prodotta da S.T.S.R. Studio Tecnico Sviluppo e Ricerche - www.stsr.it

TECHNICAL CHARACTERISTICS:

The series is equipped with thermostatic cartridge, produced by S.T.S.R. Research Development Technical Office - www.stsr.it

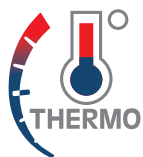

Termostatico. L'utilizzo dei modelli termostatici può aiutare ad avere un maggiore controllo sul consumo di acqua ed energia.

Thermostatic. The use of thermostatic models can help you to have more control over the energy and water consumption.

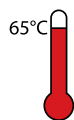
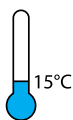
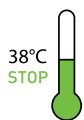

L'utilizzo dei modelli termostatici può aiutare ad avere un maggiore controllo sul consumo di acqua e energia, risparmiando la quantità di acqua solitamente sprecata cercando la temperatura desiderata.

The use of thermostatic models can help you to have more control over the energy and water consumption, saving the amount of water usually wasted looking for the desired temperature.



TERMOSTATICI
TERMOSTATICSS

X-FACTOR

Q-FACTOR

SKYLINE
THERMO

SUVI
THERMO

OXY
THERMO

THERMO



LAVABI E BIDET - WASHBASIN AND BIDET MIXERS



TH110
Miscelatore termostatico lavabo con scarico.
Thermostatic basin mixer with pop-up waste.



TH115
Miscelatore termostatico bidet con scarico.
Thermostatic bidet mixer with pop-up waste.

MISCELATORI VASCA E DOCCIA - BATH & SHOWER MIXERS



TH107
Miscelatore termostatico monoblocco vasca/doccia con set doccia.
Thermostatic monobloc bath mixer with shower set.



TH104
Miscelatore termostatico monoblocco vasca/doccia senza set doccia.
Thermostatic monobloc bath mixer without shower set.



TH105
Miscelatore termostatico monoblocco vasca/doccia con saliscendi.
Thermostatic monobloc bath mixer with sliding bar.



TH109
Miscelatore termostatico doccia esterno con saliscendi.
Thermostatic shower mixer with sliding bar.



TH106
Miscelatore termostatico doccia esterno con set doccia.
Thermostatic shower mixer with shower set.



TH103
Miscelatore termostatico doccia esterno senza set doccia.
Thermostatic shower mixer without shower set.



TH120
Miscelatore lavello termostatico.
Thermostatic sink mixer.



X-FACTOR

Q-FACTOR

SKYLINE
THERMO

SUVI
THERMO

OXY
THERMO

THERMO



LAVELLI SINKS





CUCINA
KITCHEN

LAVELLI
SINKS

ACQUA
DEPURATA
PURIFIED
WATER

TOUCH-ME

COLOUR
AMBIENT

GOURMET

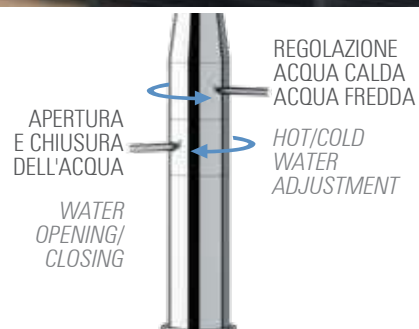
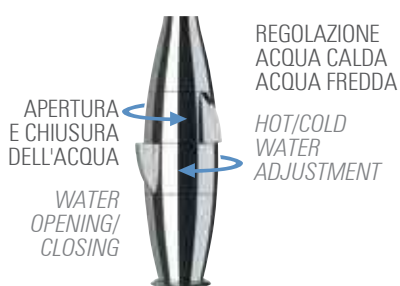
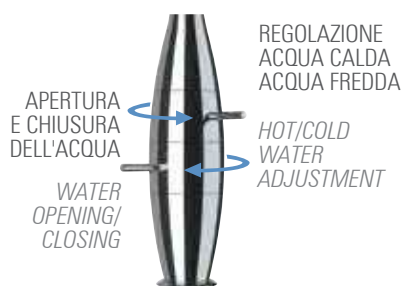

**KC301**

Miscelatore lavello bicomando con bocca girevole.
Altezza: 44,8 cm - Interasse: 21,1 cm.
Double-lever mixer with movable spout.
Height: 44,8 cm - Interaxis: 21,1 cm.

**KC302**

Miscelatore lavello bicomando con bocca girevole.
Altezza: 44,8 cm - Interasse: 21,1 cm.
Double-lever mixer with movable spout.
Height: 44,8 cm - Interaxis: 21,1 cm.

**KC303**

Miscelatore lavello bicomando con bocca girevole.
Altezza: 44,8 cm - Interasse: 21,1 cm.
Double-lever mixer with movable spout.
Height: 44,8 cm - Interaxis: 21,1 cm.

**KC101**

Miscelatore monocomando lavello con leva laterale e bocca girevole. Dotato di cartuccia Ø25.
Altezza: 44,1 cm - Interasse: 21,1 cm.
Single-lever sink mixer with side lever and movable spout. Equipped with Ø25 cartridge.
Height: 44,1 cm - Interaxis: 21,1 cm.

**KC202**

Miscelatore monocomando lavello con leva laterale e bocca girevole. Dotato di cartuccia Ø25.

Altezza: 45,4 cm - Interasse: 18 cm.
Single-lever sink mixer with side lever and movable spout. Equipped with Ø25 cartridge.
Height: 45,4 cm - Interaxis: 18 cm.

**KC201**

Miscelatore monocomando lavello con leva laterale e bocca girevole. Dotato di cartuccia Ø25.

Altezza: 43,2 cm - Interasse: 18,6 cm.
Single-lever sink mixer with side lever and movable spout. Equipped with Ø25 cartridge.
Height: 43,2 cm - Interaxis: 18,6 cm.

**KCN211**

Miscelatore lavello monocomando con canna nera girevole, base quadrata, con doccetta a 2 getti.

Altezza: 57,5 cm - Interasse: 25 cm.
Single-lever mixer with black movable spout, squared base, with 2 jets handshower.
Height: 57,5 cm - Interaxis: 25 cm.

**KCN111**

Miscelatore lavello monocomando con canna nera girevole, base tonda, con doccetta a 2 getti.

Altezza: 57,5 cm - Interasse: 25 cm.
Single-lever mixer with black movable spout, round base, with 2 jets handshower.
Height: 57,5 cm - Interaxis: 25 cm.

**KCB211**

Miscelatore lavello monocomando con canna bianca girevole, base quadrata, con doccetta a 2 getti.

Altezza: 57,5 cm - Interasse: 25 cm.
Single-lever mixer with white movable spout, squared base, with 2 jets handshower.
Height: 57,5 cm - Interaxis: 25 cm.

**KCB111**

Miscelatore lavello monocomando con canna bianca girevole, base tonda, con doccetta a 2 getti.

Altezza: 57,5 cm - Interasse: 25 cm.
Single-lever mixer with white movable spout, round base, with 2 jets handshower.
Height: 57,5 cm - Interaxis: 25 cm.

**KC211**

Miscelatore lavello monocomando con canna cromata girevole, base quadrata, con doccetta a 2 getti.

Altezza: 57,5 cm - Interasse: 25 cm.
Single-lever mixer with chrome movable spout, squared base, with 2 jets handshower.
Height: 57,5 cm - Interaxis: 25 cm.

**KC111**

Miscelatore lavello monocomando con canna cromata girevole, base tonda, con doccetta a 2 getti.

Altezza: 57,5 cm - Interasse: 25 cm.
Single-lever mixer with chrome movable spout, round base, with 2 jets handshower.
Height: 57,5 cm - Interaxis: 25 cm.

**KC2201**

Monocomando lavello bocca girevole.
Altezza: 25 cm - Interasse: 20 cm.
Single-lever Sink mixer swivelling spout.
Height: 25 cm - Interaxis: 20 cm.

**KC2101**

Monocomando lavello bocca girevole.
Altezza: 24,8 cm - Interasse: 20 cm.
Single-lever Sink mixer swivelling spout.
Height: 24,8 cm - Interaxis: 20 cm.

**SK608**

Monocomando lavello con bocca girevole.
Altezza: 23,5 cm - Interasse: 20,5 cm.
Single lever one-hole sink mixer, with movable spout.
Height: 23,5 cm - Interaxis: 20,5 cm.

**S20608**

Monocomando lavello con bocca girevole.
Altezza: 26 cm - Interasse: 18,5 cm.
Single lever one-hole sink mixer, with movable spout.
Height: 26 cm - Interaxis: 18,5 cm.

**DV608**

Monocomando lavello girevole.
Altezza: 22,7 cm - Interasse: 18 cm.
Swivelling single-lever Sink mixer.
Height: 22,7 cm - Interaxis: 18 cm.

**S20613**

Miscelatore monocomando lavello con doccia estraibile.
Altezza: 29 cm - Interasse: 20,5 cm.
Single-lever sink mixer with pull-out spray-jet shower.
Height: 29 cm - Interaxis: 20,5 cm.

**OX23617**

Monocomando lavello con canna girevole.
Altezza: 31 cm - Interasse: 22 cm.
Single-lever sink mixer with swiveling spout.
Height: 31 cm - Interaxis: 22 cm.

**SK617**

Miscelatore monocomando per lavello, con bocca alta a "U" girevole.
Altezza: 31 cm - Interasse: 22 cm.
Single-lever one-hole sink mixer, with high "U" movable spout.
Height: 31 cm - Interaxis: 22 cm.

**PR21619**

Miscelatore monocomando lavello con bocca alta girevole. Regolazione con cartuccia a dischi ceramici Ø35 mm.
Altezza: 41,6 cm - Interasse: 21,5 cm.
Single-lever sink mixer with high movable spout. Adjust with cartridge with ceramic discs Ø35 mm.
Height: 41,6 cm - Interaxis: 21,5 cm.

**PR21627**

Miscelatore monocomando lavello con bocca alta girevole e doccia estraibile. Regolazione con cartuccia a dischi ceramici Ø35 mm.
Altezza: 47,5 cm - Interasse: 23,5 cm.
Single-lever sink mixer with high movable spout and pull-out shower. Adjust with cartridge with ceramic discs Ø35.
Height: 47,5 cm - Interaxis: 23,5 cm.

**FU618**

Miscelatore lavello monoforo 90° con canna alta a "U" girevole.
Altezza: 33,5 cm - Interasse: 17,5 cm.
Single-lever sink mixer 90° with high mvable "U" spout, luxury type.
Height: 33,5 cm - Interaxis: 17,5 cm.

**FU618C**

Miscelatore monocomando per lavello, con canna corta a "U" girevole, tipo lusso.
Altezza: 30 cm - Interasse: 12 cm.
Single-lever one-hole sink mixer, with short "U" movable spout, luxury type.
Height: 30 cm - Interaxis: 12 cm.

**TA618**

Miscelatore lavello monoforo 90° con canna alta a "U" girevole.
Altezza: 33,5 cm - Interasse: 17,5 cm.
Single-lever sink mixer 90° with high mvable "U" spout, luxury type.
Height: 33,5 cm - Interaxis: 17,5 cm.

**TA618C**

Miscelatore monocomando per lavello, con canna corta a "U" girevole, tipo lusso.
Altezza: 30 cm - Interasse: 12 cm.
Single-lever one-hole sink mixer, with short "U" movable spout, luxury type.
Height: 30 cm - Interaxis: 12 cm.

**OM618**

Miscelatore lavello monoforo 90° con canna alta a "U" girevole.
Altezza: 33,5 cm - Interasse: 17,5 cm.
Single-lever sink mixer 90° with high mvable "U" spout, luxury type.
Height: 33,5 cm - Interaxis: 17,5 cm.

**OM618C**

Miscelatore monocomando per lavello, con canna corta a "U" girevole, tipo lusso.
Altezza: 30 cm - Interasse: 12 cm.
Single-lever one-hole sink mixer, with short "U" movable spout, luxury type.
Height: 30 cm - Interaxis: 12 cm.

**SR618**

Miscelatore lavello monoforo 90° con canna alta a "U" girevole.
Altezza: 33,5 cm - Interasse: 17,5 cm.
Single-lever sink mixer 90° with high mvable "U" spout, luxury type.
Height: 33,5 cm - Interaxis: 17,5 cm.

**SR618C**

Miscelatore monocomando per lavello, con canna corta a "U" girevole, tipo lusso.
Altezza: 30 cm - Interasse: 12 cm.
Single-lever one-hole sink mixer, with short "U" movable spout, luxury type.
Height: 30 cm - Interaxis: 12 cm.

LAVELLI - SINKS



FU614B

Miscelatore monocomando per lavello, con bocca alta girevole.
Altezza: 30 cm - Interasse: 17 cm.
Single-lever one-hole sink mixer, with high movable spout.
Height: 30 cm - Interaxis: 17 cm.



FU614BC

Miscelatore monocomando per lavello, con canna corta girevole.
Altezza: 26 cm - Interasse: 12,5 cm.
Single-lever one-hole sink mixer, with short "U" spout, luxury type.
Height: 26 cm - Interaxis: 12,5 cm.



TA614B

Miscelatore monocomando per lavello, con bocca alta girevole.
Altezza: 30 cm - Interasse: 17 cm.
Single-lever one-hole sink mixer, with high movable spout.
Height: 30 cm - Interaxis: 17 cm.



TA614BC

Miscelatore monocomando per lavello, con canna corta girevole.
Altezza: 26 cm - Interasse: 12,5 cm.
Single-lever one-hole sink mixer, with short "U" spout, luxury type.
Height: 26 cm - Interaxis: 12,5 cm.



OM614B

Miscelatore monocomando per lavello, con bocca alta girevole.
Altezza: 30 cm - Interasse: 17 cm.
Single-lever one-hole sink mixer, with high movable spout.
Height: 30 cm - Interaxis: 17 cm.



OM614BC

Miscelatore monocomando per lavello, con canna corta girevole.
Altezza: 26 cm - Interasse: 12,5 cm.
Single-lever one-hole sink mixer, with short movable spout.
Height: 26 cm - Interaxis: 12,5 cm.



SR614B

Miscelatore monocomando per lavello, con bocca alta girevole.
Altezza: 30 cm - Interasse: 17 cm.
Single-lever one-hole sink mixer, with high movable spout.
Height: 30 cm - Interaxis: 17 cm.



SR614BC

Miscelatore monocomando per lavello, con canna corta girevole.
Altezza: 26 cm - Interasse: 12,5 cm.
Single-lever one-hole sink mixer, with short movable spout.
Height: 26 cm - Interaxis: 12,5 cm.



**SRE618LT8**

Miscelatore lavello monoforo 90° con canna alta girevole.

Altezza: 33,5 cm - Interasse: 17,5 cm.

Single-lever sink mixer 90° with high movable spout.

Height: 33,5 cm - Interaxis: 17,5 cm.

LAVELLI
SINKSACQUA
DEPURATA
PURIFIED
WATER

TOUCH-ME

COLOUR
AMBIENT

GOURMET

**SRE618CLT8**

Miscelatore lavello monoforo 90° con canna alta girevole, modello corto.

Altezza: 30 cm - Interasse: 12 cm.

Single-lever sink mixer 90° with movable spout, short type.

Height: 30 cm - Interaxis: 12 cm.

**OME618LT8**

Miscelatore lavello monoforo 90° con canna alta girevole.

Altezza: 33,5 cm - Interasse: 17,5 cm.

Single-lever sink mixer 90° with high movable spout.

Height: 33,5 cm - Interaxis: 17,5 cm.

**OME618CLT8**

Miscelatore lavello monoforo 90° con canna alta girevole, modello corto.

Altezza: 30 cm - Interasse: 12 cm.

Single-lever sink mixer 90° with movable spout, short type.

Height: 30 cm - Interaxis: 12 cm.





MISCELATORI CON TEMPORIZZAZIONE ELETTRONICA PER LAVATRICE/LAVASTOVIGLIE
ELECTRONIC TIMING MIXERS FOR WASHING MACHINE/DISHWASHER



Due modelli di miscelatori monocomando per cucina che integrano in un elegante design la funzione di sicurezza della temporizzazione elettronica per l'utilizzo dell'acqua destinata agli elettrodomestici. Tramite un pulsante piezoelettrico posto sulla sommità del miscelatore, è infatti possibile gestire l'apertura e la chiusura del flusso destinato alla lavatrice/lavastoviglie, controllando la durata dell'erogazione. La pressione del tasto comanda l'apertura dell'acqua e la temporizzazione prestabilita interromperà automaticamente la fornitura dopo 3 ore (una pressione) o 12 ore (due pressioni). L'utilizzo dell'acqua per il lavello resta indipendente e gestibile tramite la leva di miscelazione secondo la modalità tradizionale. Alimentazione sottolavabo a batteria.

Two models of single-lever kitchen mixers that integrate the electronic timing security function for the household appliances use of water in an elegant design. By means of a piezoelectric button placed on the top of the mixer, it is in fact possible to manage the opening and closing of the flow destined for the washing machine/dishwasher, checking the supply duration. The button pressure controls the water opening and the preset timing will automatically interrupt the supply after 3 hours (one pressure) or 12 hours (two pressures). The use of water for the sink remains independent and can be managed using the mixing lever according to the traditional way. Under-sink battery-powered supply.



TEMT608WM

Miscelatore monocomando per lavello con tasto elettronico di sicurezza per la temporizzazione dell'acqua alla lavatrice/lavastoviglie. Chiusura automatica dell'acqua all'elettrodomestico dopo 3 o 12 ore (doppia temporizzazione). Angolo di rotazione della canna di 155°. Altezza: 29,5 cm - Interasse: 21,5 cm. Single-lever sink mixer with water electronic safety timing button in the washing machine/dishwasher. Automatic appliance water closing after 3 or 12 hours (double timing). Spout rotation angle 155°. Height: 29,5 cm - Interaxis: 21,5 cm.



TEMT608QWM

Miscelatore monocomando per lavello, design squadrato, con tasto elettronico di sicurezza per la temporizzazione dell'acqua alla lavatrice/lavastoviglie. Chiusura automatica dell'acqua all'elettrodomestico dopo 3 o 12 ore (doppia temporizzazione). Angolo di rotazione della canna di 155°. Altezza: 29,8 cm - Interasse: 21,4 cm. Single-lever sink mixer with water electronic safety timing button in the washing machine/dishwasher, squared design. Automatic appliance water closing after 3 or 12 hours (double timing). Spout rotation angle 155°. Height: 29,8 cm - Interaxis: 21,4 cm.





MISCELATORI A 3 VIE PER ACQUA DEPURATA - 3-WAY MIXERS FOR DEPURED WATER

La linea di miscelatori dedicati all'acqua depurata si arricchisce di nuovi modelli, avvalendosi delle migliori tecnologie disponibili per gestire i diversi flussi con semplicità e sicurezza.

The mixers line dedicated to purified water is enriched with new models, using the best available technologies to manage the different flows with simplicity and safety.



SR679PRDW

Miscelatore monocomando a 3 vie con leva laterale. È possibile selezionare tra acqua depurata o acqua miscelata tramite la rotazione della parte terminale della bocca di erogazione.

Due percorsi di ingresso separati dividono l'acqua miscelata dall'acqua filtrata e portano a due sezioni distinte dell'aeratore.

Altezza: 36 cm - Interasse: 19 cm.

3-way single-lever mixer with side lever. It is possible to select between purified water or mixed water by rotating the end part of the spout.

Two separate inlets divide the mixed water from the filtered water and lead to two distinct sections of the aerator.

Height: 36 cm - Interaxis: 19 cm.



S20679TFDW

Miscelatore monocomando a 3+2 vie con tastiera elettronica di selezione per gestire fino a 3 ingressi (ad esempio depurata, frizzante e rinfrescata).

Da collegare agli appositi apparecchi di depurazione, gassificazione e/o filtri.

La tastiera elettronica permette di selezionare l'ingresso desiderato per poi attivare ed interrompere l'erogazione corrispondente.

La leva di miscelazione regola invece l'acqua calda/fredda non filtrata secondo la funzionalità tradizionale.

Alimentazione elettrica sottolavabo.

Altezza: 36 cm - Interasse: 17 cm.

3+2-way single-lever mixer with electronic keyboard selection to manage up to 3 inputs (for example purified, sparkling and refreshed).

To be connected to the appropriate purification, gasification devices and/or filters.

The electronic keyboard allows to select the desired input and then to activate and to stop the corresponding water delivery.

The mixing lever instead regulates the unfiltered hot/cold water according to traditional functionality.

Under-sink electric power supply.

Height: 36 cm - Interaxis: 17 cm.



MISCELATORI CON GESTIONE ELETTRONICA PER ACQUA DEPURATA
MIXERS WITH DEPURATED WATER ELECTRONIC MANAGEMENT



Nei miscelatori con gestione elettronica, grazie al pulsante piezoelettrico posizionato sulla sommità, è sufficiente una leggera pressione per attivare o interrompere l'erogazione dell'acqua depurata. Ad ogni pressione corrispondono due temporizzazioni di rilascio prestabilite a 10 e 20 secondi circa, che possono essere interrotte premendo il tasto ulteriormente. La leva di miscelazione regola invece l'acqua non filtrata secondo la funzionalità tradizionale. Due percorsi di ingresso separati dividono l'acqua miscelata dall'acqua filtrata e portano a due aeratori distinti evitando qualsiasi contaminazione tra i due flussi.
Alimentazione sottolavabo a batteria.

In the electronically controlled mixers, thanks to the piezoelectric button positioned on the top, it is enough a light pressure to activate or to stop the purified water supply. Each press refers to two different release timings set (at about 10 and 20 seconds); flow can be interrupted by pressing the button further. The mixing lever instead regulates the unfiltered water according to traditional functionality. Two separate inlets divide the mixed water from the filtered water and lead to two distinct aerators, thus avoiding any contamination between the two flows. Under-sink battery-powered supply.



TEMT608DW

Miscelatore lavello a tre vie di ingresso con bocca girevole, con selezione acqua potabile tramite pulsante ad azionamento piezoelettrico alimentato a batteria, con 2 aeratori in uscita.
Altezza: 29,5 cm - Interasse: 21,5 cm.
Three ways inlet single lever sink mixer, with movable spout, with selection for drinking water with piezoelectric activation button, with 2 exit aerators.
Height: 29,5 cm - Interaxis: 21,5 cm.



TEMT608QDW

Miscelatore lavello quadrato a tre vie di ingresso con bocca girevole, con selezione acqua potabile tramite pulsante ad azionamento piezoelettrico alimentato a batteria, con 2 aeratori in uscita.
Altezza: 29,5 cm - Interasse: 21,5 cm.
Three ways inlet squared single lever sink mixer, with movable spout, with selection for drinking water with piezoelectric activation button, with 2 exit aerators.
Height: 29,5 cm - Interaxis: 21,5 cm.





MISCELATORI A 3 VIE PER ACQUA DEPURATA - 3-WAY MIXERS FOR DEPURED WATER



GOURMET

La linea di miscelatori dedicati all'acqua depurata si completa con una vasta gamma di modelli a 3 vie adatti a gestire i diversi ingressi con semplicità e sicurezza.

Un deviatore posto sul corpo del rubinetto permette la selezione tra acqua depurata e acqua miscelata.

La leva di miscelazione regola invece l'apertura e la chiusura dei flussi come da funzionalità tradizionale.

The purified water mixers line is completed with a wide range of 3-way models suitable for managing the various inlets with simplicity and safety.

A diverter placed on the tap body allows the selection between purified water and mixed water.

The mixing lever instead regulates the opening and closing of the flows as per traditional functionality.



S20608DW

Miscelatore lavello a tre vie di ingresso con bocca girevole, con selezione acqua potabile tramite la leva, con 2 aeratori indipendenti in uscita.

Altezza: 31,7 cm - Interasse: 21,5 cm.

Three ways inlet single lever sink mixer, with movable spout, with selection for drinking water directly from the lever, with 2 independent exit aerators.

Height: 31,7 cm - Interaxis: 21,5 cm.



SK608DW

Miscelatore lavello quadrato a tre vie di ingresso con bocca girevole, con selezione acqua potabile tramite la leva, con 2 aeratori indipendenti in uscita.

Altezza: 31,6 cm - Interasse: 21,7 cm.

Three ways inlet squared single lever sink mixer, with movable spout, with selection for drinking water directly from the lever, with 2 independent exit aerators.

Height: 31,6 cm - Interaxis: 21,7 cm.



OX23608DW

Miscelatore lavello a tre vie di ingresso, bocca girevole, con selezione acqua potabile tramite la leva, con 2 aeratori in uscita.

Altezza: 32 cm - Interasse: 21,8 cm.

Three ways inlet single lever sink mixer, with movable spout, with selection for drinking water directly from the lever, with 2 exit aerators.

Height: 32 cm - Interaxis: 21,8 cm.



FU679DW

Miscelatore lavello a tre vie di ingresso con bocca girevole e due vie d'uscita completamente indipendenti, con selezione acqua potabile tramite la leva.

Altezza: 35,7 cm - Interasse: 17,2 cm.

Three ways inlet single lever sink mixer, with movable spout and two fully independent outlets, with selection for drinking water directly from the lever.

Height: 35,7 cm - Interaxis: 17,2 cm.

**S20679DW**

Miscelatore lavello serie Suvi a tre vie di ingresso con bocca girevole e due vie d'uscita completamente indipendenti, con selezione acqua potabile tramite la leva.
Altezza: 35,7 cm - Interasse: 17,2 cm.
Three ways inlet Suvi series single lever sink mixer, with movable spout and two fully independent outlets, with selection for drinking water directly from the lever.
Height: 35,7 cm - Interaxis: 17,2 cm.

**OM679DW**

Miscelatore lavello a tre vie di ingresso con bocca girevole e due vie d'uscita completamente indipendenti, con selezione acqua potabile tramite la leva.
Altezza: 35,7 cm - Interasse: 17,2 cm.
Three ways inlet single lever sink mixer, with movable spout and two fully independent outlets, with selection for drinking water directly from the lever.
Height: 35,7 cm - Interaxis: 17,2 cm.

**SR679DW**

Miscelatore lavello a tre vie di ingresso con bocca girevole e due vie d'uscita completamente indipendenti, con selezione acqua potabile tramite la leva.
Altezza: 35,7 cm - Interasse: 17,2 cm.
Three ways inlet single lever sink mixer, with movable spout and two fully independent outlets, with selection for drinking water directly from the lever.
Height: 35,7 cm - Interaxis: 17,2 cm.

**TA679DW**

Miscelatore lavello a tre vie di ingresso con bocca girevole e due vie d'uscita completamente indipendenti, con selezione acqua potabile tramite la leva.
Altezza: 35,7 cm - Interasse: 17,2 cm.
Three ways inlet single lever sink mixer, with movable spout and two fully independent outlets, with selection for drinking water directly from the lever.
Height: 35,7 cm - Interaxis: 17,2 cm.

**ES5629DW**

Miscelatore lavello a tre vie di ingresso con bocca girevole, con selezione acqua potabile tramite leva, con 2 aeratori in uscita.
Altezza bocca: 18 cm - Interasse: 23 cm.
Tree ways inlet single lever sink mixer, with movable spout, with selection for drinking water directly from the lever, with 2 exit aerators.
Height spout: 18 cm - Interaxis: 23 cm.

**ES5622**

Miscelatore lavello monoforo con selettore acqua potabile (3 vie d'ingresso).
Altezza bocca: 20 cm - Interasse: 22 cm.
Single-lever sink mixer with selector for drinking water (3 ways inlet).
Height spout: 20 cm - Interaxis: 22 cm.

**SA1622**

Miscelatore lavello monoforo con selettore acqua potabile (tre vie di ingresso).
Altezza: 20 cm - Interasse: 22 cm.
Single-lever sink mixer with selector for drinking water (3 ways inlet).
Height: 20 cm - Interaxis: 22 cm.



Touch-Me è un rubinetto semplice da installare e dal funzionamento eccezionalmente pratico.

Funziona a batterie, non ingombra sotto il lavello, non richiede particolare manutenzione e renderà le operazioni in cucina veloci e divertenti.

Garantito il risparmio idrico ed energetico.

La leva di miscelazione viene "isolata" dal controllo Touch-Me per permettere di operare con la leva le normali operazioni di gestione di flusso e temperatura, una gestione che rimane quindi identica al normale rubinetto per una praticità d'uso totale.

Touch-Me is a mixer simple to install and with an extremely practical operation.

It works with batteries, does not take space under the sink, does not require special maintenance and makes the cooking operations fast and funny.

Water and energy saving is guaranteed.

The mixing lever is "insulated" from the Touch-Me control to also allow the user to manage the flow and temperature like in a normal mixer and have a total comfort of use.



CE 

KCT202

Miscelatore monocomando lavello con tecnologia touch-me con leva laterale e bocca girevole. Dotato di cartuccia Ø25.

Altezza: 46,4 cm - Interasse: 18 cm.

Single-lever sink mixer touch-me system with side lever and movable spout. Equipped with Ø25 cartridge.

Height: 46,4 cm - Interaxis: 18 cm.



CE 

KCT201

Miscelatore monocomando lavello con tecnologia touch-me con leva laterale e bocca girevole. Dotato di cartuccia Ø25.

Altezza: 44 cm - Interasse: 18,6 cm.

Single-lever sink mixer touch-me system with side lever and movable spout. Equipped with Ø25 cartridge.

Height: 44 cm - Interaxis: 18,6 cm.



CE 

KCT101

Miscelatore monocomando lavello con tecnologia touch-me con leva laterale e bocca girevole. Dotato di cartuccia Ø25.

Altezza: 44,9 cm - Interasse: 21,1 cm.

Single-lever sink mixer touch-me system with side lever and movable spout. Equipped with Ø25 cartridge.

Height: 44,9 cm - Interaxis: 21,1 cm.



KCT111

Miscelatore lavello monocomando con tecnologia touch-me, bocca girevole, base tonda e doccetta estraibile a 2 getti.
Altezza: 58,5 cm - Interasse: 25 cm.
Single-lever mixer touch-me system with movable spout, round base and 2 jets pull-out handshower.
Height: 58,5 cm - Interaxis: 25 cm.



KCT211

Miscelatore lavello monocomando con tecnologia touch-me, bocca girevole, base quadrata e doccetta estraibile a 2 getti.
Altezza: 58,5 cm - Interasse: 25 cm.
Single-lever mixer touch-me system with movable spout, squared base and 2 jets pull-out handshower.
Height: 58,5 cm - Interaxis: 25 cm.



LAVELLI
SINKS

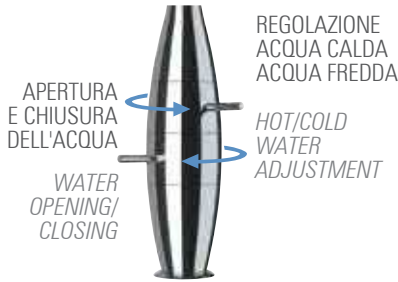

REGOLAZIONE
ACQUA CALDA
ACQUA FREDDA

HOT/COLD
WATER
ADJUSTMENT

APERTURA
E CHIUSURA
DELL'ACQUA
WATER
OPENING/
CLOSING

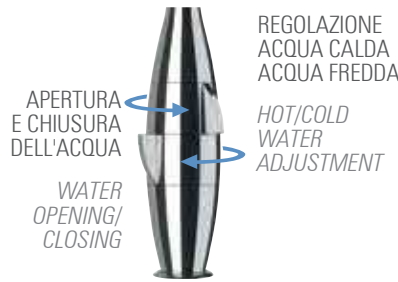

REGOLAZIONE
ACQUA CALDA
ACQUA FREDDA

HOT/COLD
WATER
ADJUSTMENT

APERTURA
E CHIUSURA
DELL'ACQUA
WATER
OPENING/
CLOSING

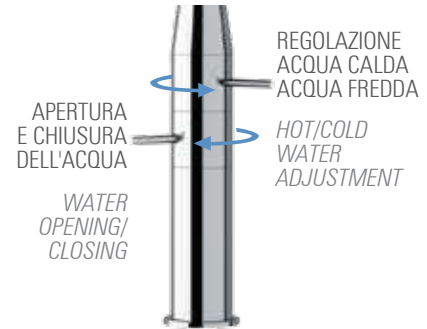

REGOLAZIONE
ACQUA CALDA
ACQUA FREDDA

HOT/COLD
WATER
ADJUSTMENT

APERTURA
E CHIUSURA
DELL'ACQUA
WATER
OPENING/
CLOSING

ACQUA
DEPURATA
PURIFIED
WATER

TOUCH-ME



KCT301

Miscelatore lavello bicomando con tecnologia touch-me e bocca girevole.
Altezza: 45,6 cm - Interasse: 21,1 cm.
Double-lever mixer touch-me system with movable spout.
Height: 45,6 cm - Interaxis: 21,1 cm.



KCT303

Miscelatore lavello bicomando con tecnologia touch-me e bocca girevole.
Altezza: 45,6 cm - Interasse: 21,1 cm.
Double-lever mixer touch-me system with movable spout.
Height: 45,6 cm - Interaxis: 21,1 cm.



KCT302

Miscelatore lavello bicomando con tecnologia touch-me e bocca girevole.
Altezza: 45,6 cm - Interasse: 21,1 cm.
Double-lever mixer touch-me system with movable spout.
Height: 45,6 cm - Interaxis: 21,1 cm.



COLOUR
AMBIENT

GOURMET

TOUCH-ME BASIC



SRT618U

Miscelatore monocomando lavello, monoforo 90° con canna alta quadra a "U" dotata di tecnologia Touch-Me con leva laterale e bocca girevole. Dotato di cartuccia Ø35.
Altezza: 33 cm - Interasse: 21,5 cm.
Single-lever sink mixer 90°, high squared "U" spout equipped with Touch-Me system with side lever and movable spout. Equipped with Ø35 cartridge.
Height: 33 cm - Interaxis: 21,5 cm.



OMT618U

Miscelatore monocomando lavello, monoforo 90° con canna alta quadra a "U" dotata di tecnologia Touch-Me con leva laterale e bocca girevole. Dotato di cartuccia Ø35.
Altezza: 33 cm - Interasse: 21,5 cm.
Single-lever sink mixer 90°, high squared "U" spout equipped with Touch-Me system with side lever and movable spout. Equipped with Ø35 cartridge.
Height: 33 cm - Interaxis: 21,5 cm.



TOUCH-ME



FUT618

Miscelatore monocomando lavello, monoforo 90° con canna alta ad "U" dotata di tecnologia Touch- Me con leva laterale e bocca girevole. Dotato di cartuccia Ø35. Altezza: 34 cm - Interasse: 17,5 cm.
Single-lever sink mixer 90°, high "U" spout equipped with Touch-Me system with side lever and movable spout. Equipped with Ø35 cartridge.
 Height: 34 cm - Interaxis: 17,5 cm.



SRT618

Miscelatore monocomando lavello, monoforo 90° con canna alta a "U" dotata di tecnologia Touch-Me con leva laterale e bocca girevole. Dotato di cartuccia Ø35. Altezza: 34 cm - Interasse: 17,5 cm.
Single-lever sink mixer 90°, high "U" spoutequipped with Touch-Me system with side lever and movable spout. Equipped with Ø35 cartridge.
 Height: 34 cm - Interaxis: 17,5 cm.



TAT618

Miscelatore monocomando lavello, monoforo 90° con canna alta ad "U" dotata di tecnologia Touch- Me con leva laterale e bocca girevole. Dotato di cartuccia Ø35. Altezza: 34 cm - Interasse: 17,5 cm.
Single-lever sink mixer 90°, high "U" spout equipped with Touch-Me system with side lever and movable spout. Equipped with Ø35 cartridge.
 Height: 34 cm - Interaxis: 17,5 cm.



OMT618

Miscelatore monocomando lavello, monoforo 90° con canna alta a "U" dotata di tecnologia Touch-Me con leva laterale e bocca girevole. Dotato di cartuccia Ø35. Altezza: 34 cm - Interasse: 17,5 cm.
Single-lever sink mixer 90°, high "U" spoutequipped with Touch-Me system with side lever and movable spout. Equipped with Ø35 cartridge.
 Height: 34 cm - Interaxis: 17,5 cm.



FUT618C

Miscelatore monocomando lavello, monoforo 90° con canna corta ad "U" dotata di tecnologia Touch-Me con leva laterale e bocca girevole. Dotato di cartuccia Ø35. Altezza: 31 cm - Interasse: 12 cm.
Single-lever sink mixer 90°, short "U" spout equipped with Touch-Me system with side lever and movable spout. Equipped with Ø35 cartridge.
 Height: 31 cm - Interaxis: 12 cm.



SRT618C

Miscelatore monocomando lavello, monoforo 90° con canna corta a "U" dotata di tecnologia Touch-Me con leva laterale e bocca girevole. Dotato di cartuccia Ø35. Altezza: 31 cm - Interasse: 12 cm.
Single-lever sink mixer 90°, short model "U" spout equipped with Touch-Me system with side lever and movable spout. Equipped with Ø35 cartridge.
 Height: 31 cm - Interaxis: 12 cm.



SKT617

Miscelatore monocomando per lavello, con bocca alta a "U" girevole dotato di tecnologia touch-me. Altezza: 31,5 cm - Interasse: 22 cm.
Single-lever one-hole sink mixer, with high "U" movable spout and equipped with touch-me technology.
 Height: 31,5 cm - Interaxis: 22 cm.



TOUCH-ME

L'alta tecnologia a servizio della comodità in cucina. I modelli di rubinetteria da lavello con funzionalità TOUCH-ME permettono di attivare ed interrompere l'erogazione dell'acqua con un semplice tocco del miscelatore, senza dover impugnare la leva di miscelazione. Un'innovazione tecnologica di grande aiuto per limitare il contatto col miscelatore permettendoci di svolgere le operazioni in cucina anche con le mani sporche o impegnate. Per aprire e chiudere l'acqua sarà ad esempio sufficiente toccare la bocca o il corpo del miscelatore con il polso o l'avambraccio; velocizzando i tempi, conservando un alto livello di igiene e riducendo il consumo idrico al solo momento di utilizzo.

Nei seguenti modelli di miscelatore, il dispositivo con tecnologia TOUCH-ME in dotazione è il modello FULL OPTIONAL e permette all'utente finale la personalizzazione o gestione di diverse funzionalità.

CARATTERISTICHE TECNICHE:

- Alimentato da 4 batterie AA litio 1,5V.
- Il rubinetto su cui viene installato il sistema TOUCH potrà sempre essere utilizzato come un normale rubinetto, scollegando la funzione TOUCH in qualsiasi momento.
- Prima del blocco da "batteria scarica", le valvole vengono commutate in posizione aperta e la funzione touch si disattiva permettendo il normale utilizzo del miscelatore fino al cambio batterie avvenuto.

Il sistema TOUCH è dotato di:

- Due elettrovalvole.
- Collegamento elettrico al rubinetto per il sensore TOUCH
- Una elettronica inclusa in un apposito contenitore dove sono anche inserite le 4 batterie.

High technology at the service of comfort in the kitchen. The sink faucets models with TOUCH-ME technology allow to activate and stop the water flow with a simple touch of the mixer without need to hold the mixer lever.

A technological innovation of great help to limit contact with the mixer thus allowing to carry out the operations in the kitchen even with dirty or committed hands.

To open and close the water, for example, it will be enough to touch the spout or the mixer body with the wrist or the forearm, thus speeding up the time, maintaining a high hygiene level and reducing water consumption at the moment of use only.

In the following Sink models the TOUCH-ME device included is the FULL OPTIONAL, and allows the final user to personalize and manage several functionalities.

TECHNICAL FEATURES:

- Powered by 4 x AA sized lithium batteries 1,5V.
- The faucet where the TOUCH system is installed can run as a normal mixer disconnecting the touch feature in any desired time.
- Before the batteries stop working the valves switch to open position and you will be able to use your mixer as a normal mixer (without the TOUCH function) until the batteries are changed.

The TOUCH system includes:

- Two latching solenoid valves.
- Electrical connection to faucet for TOUCH sensor.
- One electronic included in a box together with the 4 batteries.

LAVELLI
SINKSACQUA
DEPURATA
PURIFIED
WATER

TOUCH-ME

COLOUR
AMBIENT

GOURMET

TOUCH-ME COLOUR

La tecnologia COLOUR LED LIGHT abbinata ai dispositivi TOUCH-ME è disponibile in quattro varianti denominate A, B, C, D, di seguito dettagliate. Per evidenziare la Vostra scelta, aggiungere la lettera corrispondente a fine codice articolo.

A  La luce emanata è solo bianca.
The light emitted is white like.

B  La luce emanata cambia colore al variare della temperatura
Azzurro: fino a 32°
Bianco: da 32° a 38°
Rosa: oltre 38°
*The light emitted changes colour with temperature
Light Blue: up to 32°
White: from 32° to 38°
Pink: from 38°*

C  La luce emanata cambia colore al variare della temperatura
Blu: fino a 28°
Verde: da 28° a 33°
Giallo: da 33° a 38°
Rosso: da 38°
*The light emitted changes colour with temperature
Blue: up to 28°
Green: from 28° to 33°
Yellow: from 33° to 38°
Red: from 38°*

D  Un arcobaleno di colori e sfumature si alternano creando un continuo gioco emozionale
A rainbow of colors and shades alternate, creating a constant emotional game

Le temperature indicate possono variare di circa +/-2 gradi a seconda delle caratteristiche del miscelatore e dell'ambiente. I modelli A B e D oltre i 40° emaneranno luce di colore rosso come protezione.

The indicated temperatures may vary approximately by +/-2 degrees, depending on the mixer and the environment characteristics. Over 40° models A B and D will emit red light as protection.

**KCTL111**

Miscelatore lavello monocomando con tecnologia touch-me, bocca girevole, base tonda e doccetta estraibile con luce led.

Altezza: 58,5 cm - Interasse: 25 cm.
Single-lever mixer touch-me system with movable spout, round base and led light pull-out handshower.

Height: 58,5 cm - Interaxis: 25 cm.

**KCTL211**

Miscelatore lavello monocomando con tecnologia touch-me, bocca girevole, base quadrata e doccetta estraibile con luce led.

Altezza: 58,5 cm - Interasse: 25 cm.
Single-lever mixer touch-me system with movable spout, squared base and led light pull-out handshower.

Height: 58,5 cm - Interaxis: 25 cm.



AMBIENT



SKA608

Monocomando lavello con bocca girevole dotato di dispositivo luminoso AMBIENT di retroilluminazione.
 Altezza: 28,1 cm - Interasse: 20 cm.
 Single lever one-hole sink mixer, with movable spout with led light AMBIENT device of back lighting.
 Height: 28,1 cm - Interaxis: 20 cm.

CE 



SA20608

Monocomando lavello con bocca girevole dotato di dispositivo luminoso AMBIENT di retroilluminazione.
 Altezza: 27 cm - Interasse: 20 cm.
 Single lever one-hole sink mixer, with movable spout with led light AMBIENT device of back lighting.
 Height: 27 cm - Interaxis: 20 cm.

CE 



KCA201

Monocomando lavello bocca girevole dotato di dispositivo luminoso AMBIENT con illuminazione sotto la bocca di erogazione.
 Altezza: 25 cm - Interasse: 20 cm.
 Single-lever Sink mixer swivelling spout with led light AMBIENT device for back lighting.
 Height: 25 cm - Interaxis: 20 cm.

CE 



KCA101

Monocomando lavello bocca girevole dotato di dispositivo luminoso AMBIENT con illuminazione sotto la bocca di erogazione.
 Altezza: 24,8 cm - Interasse: 20 cm.
 Single-lever Sink mixer swivelling spout with led light AMBIENT device for back lighting.
 Height: 24,8 cm - Interaxis: 20 cm.

CE 

COLOUR DESIGN

La tecnologia COLOUR LED LIGHT è disponibile in quattro varianti denominate A, B, C, D, di seguito dettagliate. Per evidenziare la Vostra scelta, aggiungere la lettera corrispondente a fine codice articolo.

The COLOUR LED LIGHT technology is available in four variants named A, B, C, D, that we detail here following. To highlight your selection please add the chosen letter at the end of the article number.

A  La luce emanata è solo bianca.
The light emitted is white like.

B  La luce emanata cambia colore al variare della temperatura
Azzurro: fino a 32°
Bianco: da 32° a 38°
Rosa: oltre 38°
The light emitted changes colour with temperature
Light Blue: up to 32°
White: from 32° to 38°
Pink: from 38°

C  La luce emanata cambia colore al variare della temperatura
Blu: fino a 28°
Verde: da 28° a 33°
Giallo: da 33° a 38°
Rosso: da 38°
The light emitted changes colour with temperature
Blue: up to 28°
Green: from 28° to 33°
Yellow: from 33° to 38°
Red: from 38°

D  Un arcobaleno di colori e sfumature si alternano creando un continuo gioco emozionale
A rainbow of colors and shades alternate, creating a constant emotional game

Le temperature indicate possono variare di circa +/-2 gradi a seconda delle caratteristiche del miscelatore e dell'ambiente.
I modelli A B e D oltre i 40° emaneranno luce di colore rosso come protezione.

The indicated temperatures may vary approximately by +/-2 degrees, depending on the mixer and the environment characteristics.
Over 40° models A B and D will emit red light as protection.

LAVELLI
SINKSACQUA
DEPURATA
PURIFIED
WATER

TOUCH-ME

COLOUR
AMBIENT

GOURMET

**KCLN211**

Miscelatore lavello monocomando con canna nera girevole, base quadrata, con doccetta con dispositivo led, nei modelli: A, B, C, D.
Altezza: 57,5 cm - Interasse: 25 cm.
Single-lever mixer with black movable spout, squared base, with handshower with led light device, models: A, B, C, D.
Height: 57,5 cm - Interaxis: 25 cm.

**KCLN111**

Miscelatore lavello monocomando con canna nera girevole, base tonda, con doccetta con dispositivo led, nei modelli: A, B, C, D.
Altezza: 57,5 cm - Interasse: 25 cm.
Single-lever mixer with black movable spout, round base, with handshower with led light device, models: A, B, C, D.
Height: 57,5 cm - Interaxis: 25 cm.

**KCLB211**

Miscelatore lavello monocomando con canna bianca girevole, base quadrata, con doccetta con dispositivo led, nei modelli: A, B, C, D.
Altezza: 57,5 cm - Interasse: 25 cm.
Single-lever mixer with white movable spout, squared base, with handshower with led light device, models: A, B, C, D.
Height: 57,5 cm - Interaxis: 25 cm.

**KCLB111**

Miscelatore lavello monocomando con canna bianca girevole, base tonda, con doccetta con dispositivo led, nei modelli: A, B, C, D.
Altezza: 57,5 cm - Interasse: 25 cm.
Single-lever mixer with white movable spout, round base, with handshower with led light device, models: A, B, C, D.
Height: 57,5 cm - Interaxis: 25 cm.

**KCL211**

Miscelatore lavello monocomando con canna cromata girevole, base quadrata, con doccetta con dispositivo led, nei modelli: A, B, C, D.
Altezza: 57,5 cm - Interasse: 25 cm.
Single-lever mixer with chrome movable spout, squared base, with handshower with led light device, models: A, B, C, D.
Height: 57,5 cm - Interaxis: 25 cm.

**KCL111**

Miscelatore lavello monocomando con canna cromata girevole, base tonda, con doccetta con dispositivo led, nei modelli: A, B, C, D.
Altezza: 57,5 cm - Interasse: 25 cm.
Single-lever mixer with chrome movable spout, round base, with handshower with led light device, models: A, B, C, D.
Height: 57,5 cm - Interaxis: 25 cm.



**SL20684**

Miscelatore monocomando laterale per lavello alto, con bocca girevole a molla in acciaio inox elettrolucidata, flessibile e doccetta monogetto con luce led.
Altezza: 72 cm - Interasse: 29,5 cm max..
Single-lever mixer for sink, with side lever, high movable spring spout in stainless steel electro polished with hand shower and led light.
Height: 72 cm - Interaxis: 29,5 cm max.

CE

**OXL23684C**

Miscelatore monocomando laterale per lavello alto, con bocca girevole a molla in acciaio inox elettrolucidata, flessibile e doccetta monogetto con luce led.
Altezza: 72 cm - Interasse: 29,5 cm max..
Single-lever mixer for sink, with side lever, high movable spring spout in stainless steel electro polished with hand shower and led light.
Height: 72 cm - Interaxis: 29,5 cm max.

CE

**SL20638**

Miscelatore monocomando laterale per lavello, alto, con bocca girevole a molla in acciaio inox elettrolucidata, flessibile in acciaio inox ricoperto in pvc metallizzato e doccetta monogetto con luce led.
Altezza: 58 cm - Interasse: 18 cm.
Single-lever mixer for sink, with side lever, high movable spring spout in stainless steel electro polished with shower and led light.
Height: 58 cm - Interaxis: 18 cm.

CE

**OXL23638C**

Miscelatore monocomando laterale per lavello, alto, con bocca girevole a molla in acciaio inox elettrolucidata, flessibile in acciaio inox ricoperto in pvc metallizzato e doccetta monogetto con luce led.
Altezza: 58 cm - Interasse: 18 cm.
Single-lever mixer for sink, with side lever, high movable spring spout in stainless steel electro polished with shower and led light.
Height: 58 cm - Interaxis: 18 cm.

CE

**SL20639**

Miscelatore monocomando laterale per lavello, alto, con bocca girevole a molla in acciaio inox elettrolucidata, flessibile in acciaio inox ricoperto in pvc metallizzato e doccetta monogetto con luce led.
Altezza: 42 cm - Interasse: 18 cm.
Single-lever mixer for sink, with side lever, high movable spring spout in stainless steel electro polished with shower and led light.
Height: 42 cm - Interaxis: 18 cm.

CE

**OXL23639C**

Miscelatore monocomando laterale per lavello, alto, con bocca girevole a molla in acciaio inox elettrolucidata, flessibile in acciaio inox ricoperto in pvc metallizzato e doccetta monogetto con luce led.
Altezza: 42 cm - Interasse: 18 cm.
Single-lever mixer for sink, with side lever, high movable spring spout in stainless steel electro polished with shower and led light.
Height: 42 cm - Interaxis: 18 cm.

CE





CARATTERISTICHE TECNICHE:

- Lavello monocomando alto
- Canna girevole 360°
- Doccetta integrata a 2 funzioni
- Cartuccia Ø 35
- Doccetta estraibile ed orientabile

TECHNICAL CHARACTERISTICS:

- High Single-lever sink mixer
- Spout: 360° movable
- Hand shower: integrated 2 functions
- Cartridge: Ø 35 mm
- Extractable and adjustable hand shower

LAVELLI
SINKS

ACQUA
DEPURATA
PURIFIED
WATER

TOUCH-ME



SR201

Miscelatore lavello con flessibile rivestito in tubo gomma soft-touch nero opaco.
Altezza: 56,3 cm - Interasse: 23 cm.
Sink mixer with flexible hose coated in soft-touch matte black rubber pipe.
Height: 56,3 cm - Interaxis: 23 cm.



SR205

Miscelatore lavello con flessibile rivestito in tubo gomma soft-touch bianco opaco.
Altezza: 56,3 cm - Interasse: 23 cm.
Sink mixer with flexible hose coated in soft-touch matte white rubber pipe.
Height: 56,3 cm - Interaxis: 23 cm.

COLOUR
AMBIENT

GOURMET



SR202

Miscelatore lavello con flessibile rivestito in tubo gomma soft-touch nero opaco, maniglia verniciata nera opaca.
Altezza: 56,3 cm - Interasse: 23 cm.
Sink mixer with flexible hose coated in soft-touch matte black rubber pipe, matt black painted handle.
Height: 56,3 cm - Interaxis: 23 cm.



SR206

Miscelatore lavello con flessibile rivestito in tubo gomma soft-touch bianco opaco, maniglia verniciata bianca opaca.
Altezza: 56,3 cm - Interasse: 23 cm.
Sink mixer with flexible hose coated in soft-touch matte white rubber pipe, matt white painted handle.
Height: 56,3 cm - Interaxis: 23 cm.



SR203

Miscelatore lavello con flessibile nero rivestito con molla "fine design".
Altezza: 56,3 cm - Interasse: 23 cm.
Sink mixer with black flexible hose coated with "fine design" spring.
Height: 56,3 cm - Interaxis: 23 cm.



SR204

Miscelatore lavello con flessibile bianco rivestito con molla "fine design".
Altezza: 56,3 cm - Interasse: 23 cm.
Sink mixer with white flexible hose coated with "fine design" spring.
Height: 56,3 cm - Interaxis: 23 cm.



CARATTERISTICHE TECNICHE:

- Lavello monocomando alto
- Canna girevole 360°
- Doccetta integrata a 2 funzioni
- Cartuccia Ø 35
- Doccetta estraibile ed orientabile

TECHNICAL CHARACTERISTICS:

- High Single-lever sink mixer
- Spout: 360° movable
- Hand shower: integrated 2 functions
- Cartridge: Ø 35 mm
- Extractable and adjustable hand shower



SR211

Miscelatore lavello con flessibile rivestito in tubo gomma soft-touch nero opaco.
Altezza: 58,6 cm - Interasse: 23 cm.
Sink mixer with flexible hose coated in soft-touch matte black rubber pipe.
Height: 58,6 cm - Interaxis: 23 cm.



SR215

Miscelatore lavello con flessibile rivestito in tubo gomma soft-touch bianco opaco.
Altezza: 58,6 cm - Interasse: 23 cm.
Sink mixer with flexible hose coated in soft-touch matte white rubber pipe.
Height: 58,6 cm - Interaxis: 23 cm.



SR212

Miscelatore lavello con flessibile rivestito in tubo gomma soft-touch nero opaco, maniglia verniciata nera opaca.
Altezza: 58,6 cm - Interasse: 23 cm.
Sink mixer with flexible hose coated in soft-touch matte black rubber pipe, matt black painted handle.
Height: 58,6 cm - Interaxis: 23 cm.



SR216

Miscelatore lavello con flessibile rivestito in tubo gomma soft-touch bianco opaco, maniglia verniciata bianca opaca.
Altezza: 58,6 cm - Interasse: 23 cm.
Sink mixer with flexible hose coated in soft-touch matte white rubber pipe, matt white painted handle.
Height: 58,6 cm - Interaxis: 23 cm.



SR213

Miscelatore lavello con flessibile nero rivestito con molla "fine design".
Altezza: 58,6 cm - Interasse: 23 cm.
Sink mixer with black flexible hose coated with "fine design" spring.
Height: 58,6 cm - Interaxis: 23 cm.



SR214

Miscelatore lavello con flessibile bianco rivestito con molla "fine design".
Altezza: 58,6 cm - Interasse: 23 cm.
Sink mixer with black flexible hose coated with "fine design" spring.
Height: 58,6 cm - Interaxis: 23 cm.

CARATTERISTICHE TECNICHE:

- Lavello monocomando medio
- Canna girevole 360°
- Doccetta integrata a 2 funzioni
- Cartuccia Ø 25
- Doccetta estraibile ed orientabile

TECHNICAL CHARACTERISTICS:

- Medium Single-lever sink mixer
- Spout: 360° movable
- Hand shower: integrated 2 functions
- Cartridge: Ø 25 mm
- Extractable and adjustable hand shower

**KC121**

Miscelatore lavello con flessibile rivestito in tubo gomma soft-touch nero opaco.
Altezza: 51,5 cm - Interasse: 21 cm.
Sink mixer with flexible hose coated in soft-touch matte black rubber pipe.
Height: 51,5 cm - Interaxis: 21 cm.

**KC125**

Miscelatore lavello con flessibile rivestito in tubo gomma soft-touch bianco opaco.
Altezza: 51,5 cm - Interasse: 21 cm.
Sink mixer with flexible hose coated in soft-touch matte white rubber pipe.
Height: 51,5 cm - Interaxis: 21 cm.

**KC122**

Miscelatore lavello con flessibile rivestito in tubo gomma soft-touch nero opaco, maniglia verniciata nera opaca.
Altezza: 51,5 cm - Interasse: 21 cm.
Sink mixer with flexible hose coated in soft-touch matte black rubber pipe, matt black painted handle.
Height: 51,5 cm - Interaxis: 21 cm.

**KC126**

Miscelatore lavello con flessibile rivestito in tubo gomma soft-touch bianco opaco, maniglia verniciata bianca opaca.
Altezza: 51,5 cm - Interasse: 21 cm.
Sink mixer with flexible hose coated in soft-touch matte white rubber pipe, matt white painted handle.
Height: 51,5 cm - Interaxis: 21 cm.

**KC123**

Miscelatore lavello con flessibile nero rivestito con molla "fine design".
Altezza: 51,5 cm - Interasse: 21 cm.
Sink mixer with black flexible hose coated with "fine design" spring.
Height: 51,5 cm - Interaxis: 21 cm.

**KC124**

Miscelatore lavello con flessibile bianco rivestito con molla "fine design".
Altezza: 51,5 cm - Interasse: 21 cm.
Sink mixer with black flexible hose coated with "fine design" spring.
Height: 51,5 cm - Interaxis: 21 cm.



CARATTERISTICHE TECNICHE:

- Lavello monocomando medio
- Canna girevole 360°
- Doccetta integrata a 2 funzioni
- Cartuccia Ø 35
- Doccetta estraibile ed orientabile

TECHNICAL CHARACTERISTICS:

- Medium Single-lever sink mixer
- Spout: 360° movable
- Hand shower: integrated 2 functions
- Cartridge: Ø 35 mm
- Extractable and adjustable hand shower



SR242

Miscelatore lavello con flessibile rivestito in tubo gomma soft-touch nero opaco, maniglia verniciata nera opaca.

Altezza: 49 cm - Interasse: 21 cm.

Sink mixer with flexible hose coated in soft-touch matte black rubber pipe, matt black painted handle.

Height: 49 cm - Interaxis: 21 cm.



SR246

Miscelatore lavello con flessibile rivestito in tubo gomma soft-touch bianco opaco, maniglia verniciata bianca opaca.

Altezza: 49 cm - Interasse: 21 cm.

Sink mixer with flexible hose coated in soft-touch matte white rubber pipe, matt black painted handle.

Height: 49 cm - Interaxis: 21 cm.



SR243

Miscelatore lavello con flessibile nero rivestito con molla "fine design".

Altezza: 49 cm - Interasse: 21 cm.

Sink mixer with black flexible hose coated with "fine design" spring.

Height: 49 cm - Interaxis: 21 cm.



SR244

Miscelatore lavello con flessibile bianco rivestito con molla "fine design".

Altezza: 49 cm - Interasse: 21 cm.

Sink mixer with white flexible hose coated with "fine design" spring.

Height: 49 cm - Interaxis: 21 cm.



SR241

Miscelatore lavello con flessibile rivestito in tubo gomma soft-touch nero opaco.

Altezza: 49 cm - Interasse: 21 cm.

Sink mixer with flexible hose coated in soft-touch matte black rubber pipe.

Height: 49 cm - Interaxis: 21 cm.



SR245

Miscelatore lavello con flessibile rivestito in tubo gomma soft-touch bianco opaco.

Altezza: 49 cm - Interasse: 21 cm.

Sink mixer with flexible hose coated in soft-touch matte white rubber pipe.

Height: 49 cm - Interaxis: 21 cm.



SR243N

Miscelatore lavello con flessibile nero rivestito con molla "fine design", corpo principale e maniglia verniciati nero opaco.

Altezza: 49 cm - Interasse: 21 cm.

Sink mixer with black flexible hose coated with "fine design" spring, matt black painted main body and handle.

Height: 49 cm - Interaxis: 21 cm.



SR244B

Miscelatore lavello con flessibile bianco rivestito con molla "fine design", corpo principale e maniglia verniciati bianco opaco.

Altezza: 49 cm - Interasse: 21 cm.

Sink mixer with white flexible hose coated with "fine design" spring, matt white painted main body and handle.

Height: 49 cm - Interaxis: 21 cm.



CARATTERISTICHE TECNICHE:

- Lavello monocomando alto
- Canna girevole 360°
- Doccetta integrata a 2 funzioni
- Cartuccia Ø 35
- Doccetta estraibile ed orientabile

TECHNICAL CHARACTERISTICS:

- High Single-lever sink mixer
- Spout: 360° movable
- Hand shower: integrated 2 functions
- Cartridge: Ø 35 mm
- Extractable and adjustable hand shower

**KC231**

Miscelatore lavello con flessibile rivestito in tubo gomma soft-touch nero opaco.
Altezza: 56,4 cm - Interasse: 23 cm.
Sink mixer with flexible hose coated in soft-touch matte black rubber pipe.
Height: 56,4 cm - Interaxis: 23 cm.

**KC235**

Miscelatore lavello con flessibile rivestito in tubo gomma soft-touch bianco opaco.
Altezza: 56,4 cm - Interasse: 23 cm.
Sink mixer with flexible hose coated in soft-touch matte white rubber pipe.
Height: 56,4 cm - Interaxis: 23 cm.

**KC232**

Miscelatore lavello con flessibile rivestito in tubo gomma soft-touch nero opaco, maniglia verniciata nera opaca.
Altezza: 56,4 cm - Interasse: 23 cm.
Sink mixer with flexible hose coated in soft-touch matte black rubber pipe, matt black painted handle.
Height: 56,4 cm - Interaxis: 23 cm.

**KC236**

Miscelatore lavello con flessibile rivestito in tubo gomma soft-touch bianco opaco, maniglia verniciata bianca opaca.
Altezza: 56,4 cm - Interasse: 23 cm.
Sink mixer with flexible hose coated in soft-touch matte white rubber pipe, matt white painted handle.
Height: 56,4 cm - Interaxis: 23 cm.



CARATTERISTICHE TECNICHE:
 - Lavello: monocomando medio
 - Canna: girevole 360°
 - Doccetta: integrata a 2 funzioni
 - Cartuccia: Ø 25
 - Doccetta estraibile ed orientabile

TECHNICAL CHARACTERISTICS:
 - Medium Single-lever sink mixer
 - Spout: 360° movable
 - Hand shower: integrated 2 functions
 - Cartridge: Ø 25 mm
 - Extractable and adjustable hand shower



KC221
 Miscelatore lavello con flessibile rivestito in tubo gomma soft-touch nero opaco.
 Altezza: 51,6 cm - Interasse: 21 cm.
Sink mixer with flexible hose coated in soft-touch matte black rubber pipe.
 Height: 51,6 cm - Interaxis: 21 cm.



KC225
 Miscelatore lavello con flessibile rivestito in tubo gomma soft-touch bianco opaco.
 Altezza: 51,6 cm - Interasse: 21 cm.
Sink mixer with flexible hose coated in soft-touch matte white rubber pipe.
 Height: 51,6 cm - Interaxis: 21 cm.



KC222
 Miscelatore lavello con flessibile rivestito in tubo gomma soft-touch nero opaco, maniglia verniciata nera opaca.
 Altezza: 51,6 cm - Interasse: 21 cm.
Sink mixer with flexible hose coated in soft-touch matte black rubber pipe, matt black painted handle.
 Height: 51,6 cm - Interaxis: 21 cm.



KC226
 Miscelatore lavello con flessibile rivestito in tubo gomma soft-touch bianco opaco, maniglia verniciata bianca opaca.
 Altezza: 51,6 cm - Interasse: 21 cm.
Sink mixer with flexible hose coated in soft-touch matte white rubber pipe, matt white painted handle.
 Height: 51,6 cm - Interaxis: 21 cm.

**CARATTERISTICHE TECNICHE:**

- Lavello monocomando alto
- Canna girevole 360°
- Doccetta integrata a 2 funzioni
- Cartuccia Ø 35
- Doccetta estraibile ed orientabile

TECHNICAL CHARACTERISTICS:

- High Single-lever sink mixer
- Spout: 360° movable
- Hand shower: integrated 2 functions
- Cartridge: Ø 35 mm
- Extractable and adjustable hand shower

FU233

Miscelatore lavello monocomando con flessibile nero rivestito con molla "fine design" girevole 360°, con doccetta estraibile di supporto ed orientabile a due funzioni e cartuccia Ø 35.

Altezza: 40,7 cm - Interasse: 21 cm.

Single-lever mixer with black flexible hose coated with "fine design" spring, 360° movable, with detachable and adjustable 2-functions hand shower and Ø 35 mm cartridge.

Height: 40,7 cm - Interaxis: 21 cm.

**TA233**

Miscelatore lavello monocomando con flessibile nero rivestito con molla "fine design" girevole 360°, con doccetta estraibile di supporto ed orientabile a due funzioni e cartuccia Ø 35.

Altezza: 40,7 cm - Interasse: 21 cm.

Single-lever mixer with black flexible hose coated with "fine design" spring, 360° movable, with detachable and adjustable 2-functions hand shower and Ø 35 mm cartridge.

Height: 40,7 cm - Interaxis: 21 cm.

**S20233**

Miscelatore lavello monocomando con flessibile nero rivestito con molla "fine design" girevole 360°, con doccetta estraibile ed orientabile a due funzioni e cartuccia Ø 35.

Altezza: 40,7 cm - Interasse: 21 cm.

Single-lever mixer with black flexible hose coated with "fine design" spring, 360° movable, with pull-out and swivelling 2-functions hand shower and Ø 35 mm cartridge.

Height: 40,7 cm - Interaxis: 21 cm.

**OM233**

Miscelatore lavello monocomando a molla "fine design" girevole a 360° con doccetta estraibile ed orientabile a due funzioni e cartuccia Ø35 mm.

Altezza: 40,7 cm - Interasse: 21 cm.

Single-lever sink mixer with black flexible hose coated with "fine design" spring, 360° movable, with pull-out and swivelling 2 functions hand shower and Ø35 mm cartridge.

Height: 40,7 cm - Interaxis: 21 cm.

**SR233**

Miscelatore lavello monocomando con flessibile nero rivestito con molla "fine design" girevole 360°, con doccetta estraibile ed orientabile a due funzioni e cartuccia Ø 35.

Altezza: 40,7 cm - Interasse: 21 cm.

Single-lever mixer with black flexible hose coated with "fine design" spring, 360° movable, with pull-out and swivelling 2-functions hand shower and Ø 35 mm cartridge.

Height: 40,7 cm - Interaxis: 21 cm.





FU689

Miscelatore monocomando lavello a molla con doccetta estraibile dal supporto ed orientabile a due funzioni e cartuccia Ø 35.
 Altezza: 48 cm - Interasse: 21,5 cm.
Spring single-lever sink mixer with detachable and adjustable 2-functions hand shower and Ø 35 mm cartridge.
 Height: 48 cm - Interaxis: 21,5 cm.



TA689

Miscelatore monocomando lavello a molla con doccetta estraibile dal supporto ed orientabile a due funzioni e cartuccia Ø 35.
 Altezza: 48 cm - Interasse: 21,5 cm.
Spring single-lever sink mixer with detachable and adjustable 2-functions hand shower and Ø 35 mm cartridge.
 Height: 48 cm - Interaxis: 21,5 cm.



S20689

Miscelatore monocomando lavello a molla con doccetta estraibile ed orientabile a due funzioni e cartuccia Ø 35.
 Altezza: 48 cm - Interasse: 21,5 cm.
Spring single-lever sink mixer with pull-out and swivelling 2-functions hand shower and Ø 35 mm cartridge.
 Height: 48 cm - Interaxis: 21,5 cm.



OM689

Miscelatore lavello monocomando a molla con doccetta esraibile ed orientabile a due funzioni e cartuccia Ø35 mm.
 Altezza: 48 cm - Interasse: 21,5 cm.
Spring single-lever sink mixer with pull-out and swivelling 2 functions hand shower and Ø35 mm cartridge.
 Height: 48 cm - Interaxis: 21,5 cm.



SR689

Miscelatore monocomando lavello a molla con doccetta estraibile ed orientabile a due funzioni e cartuccia Ø 35.
 Altezza: 48 cm - Interasse: 21,5 cm.
Spring single-lever sink mixer with pull-out and swivelling 2-functions hand shower and Ø 35 mm cartridge.
 Height: 48 cm - Interaxis: 21,5 cm.



S20695T

Miscelatore monocomando laterale per lavello, alto, con bocca girevole e doccetta in ottone cromato estraibile a due funzioni. Materiale miscelatore: ottone cromato.

Canna: forma a 45°, girevole, Ø30 mm, in ottone cromato.
Altezza: 31 cm - Interasse: 18 cm.
Single-lever mixer for sink, with side lever, high movable spout with pull-out hand shower, two functions.

Material: mixer, spout and hand shower in c.p. brass.
Spout: shape 45°, swivelling, Ø 30 mm.
Height: 31 cm - Interaxis: 18 cm.



S20695M

Miscelatore monocomando laterale per lavello, alto, con bocca girevole e doccetta curva estraibile a due funzioni.

Materiale: miscelatore in ottone cromato, doccetta in ABS cromato. Canna: forma a 45°, girevole, Ø35 mm, in ottone cromato.
Altezza: 32 cm - Interasse: 20 cm.
Single-lever mixer for sink, with side lever, high movable spout with pull-out hand hower, two functions.

Material: mixer and spout in c.p. brass, hand shower in c.p. ABS. Spout: shape 45°, swivelling, Ø35 mm.
Height: 32 cm - Interaxis: 20 cm.



S20690

Miscelatore monocomando laterale per lavello, alto, con bocca girevole e doccetta ad angolo retto estraibile a due funzioni.

Materiale: miscelatore e bocca in ottone cromato, doccetta in ABS cromato.
Canna: forma a 90°, girevole, Ø35 mm.
Altezza: 31 cm - Interasse: 21 cm.
Single-lever mixer for sink, with side lever, high movable spout with 90° corner shaped pull-out hand shower, two functions.

Material: mixer and spout in c.p. brass, hand shower in c.p. ABS.
Spout: shape 90°, swivelling, Ø35 mm.
Height: 31 cm - Interaxis: 21 cm.



S20694

Miscelatore monocomando laterale per lavello, alto, con bocca girevole a molla in acciaio inox elettrolucidato, flessibile e doccetta estraibile a due funzioni.

Materiale: miscelatore in ottone cromato, molla in acciaio inox, flessibile in acciaio inox ricoperto in pvc metallizzato argento, doccetta in ABS cromato.
Altezza: 72 cm - Interasse: 29,5 cm max.
Single-lever mixer for sink, with side lever, high movable spring spout in stainless steel electro polished with pull-out hand shower, two functions.

Material: mixer in c.p. brass, spout in spring in stainless steel with stainless steel flexible covered with silver colour pvc, hand shower in c.p. ABS.
Height: 72 cm - Interaxis: 29,5 cm max.



S20690M



Miscelatore monocomando laterale per lavello, alto, con bocca girevole e doccetta curva estraibile a due funzioni.
 Materiale: miscelatore e bocca in ottone cromato, doccetta in ABS cromato.
 Canna: forma a 90°, girevole, Ø35 mm.
 Altezza: 31 cm - Interasse: 21 cm.
Single-lever mixer for sink, with side lever, high movable spout with pull-out hand shower, two functions.
 Material: mixer and spout in c.p. brass, handshower in c.p. ABS.
 Spout: shape 90°, swivelling, Ø35 mm.
 Height: 31 cm - Interaxis: 21 cm.

S20695



Miscelatore monocomando laterale per lavello, alto, con bocca girevole e doccetta estraibile a due funzioni.
 Materiale: miscelatore e bocca in ottone cromato, doccetta in ABS cromato.
 Canna: forma a 45°, girevole, Ø 30 mm.
 Altezza: 33 cm - Interasse: 23 cm.
Single-lever mixer for sink, with side lever, high movable spout with pull-out hand shower, two functions.
 Material: mixer and spout in c.p. brass, hand shower in c.p. ABS.
 Spout: shape 45°, swivelling, Ø 30 mm.
 Height: 33 cm - Interaxis: 23 cm.

S20692



Miscelatore monocomando laterale per lavello, alto, con bocca a C girevole e doccetta estraibile a due funzioni.
 Materiale: miscelatore in ottone cromato, doccetta in ABS cromato.
 Canna: forma a 180°, girevole, Ø35 mm, in ottone cromato.
 Altezza: 51 cm - Interasse: 20 cm.
Single-lever mixer for sink, with side lever, high C movable spout with pull-out hand shower, two functions.
 Material: mixer and spout in c.p. brass, hand shower in c.p. ABS.
 Spout: shape 180°, swivelling, Ø35 mm.
 Height: 51 cm - Interaxis: 20 cm.

S20693



Miscelatore monocomando laterale per lavello, alto, con bocca a J girevole e doccetta estraibile a due funzioni.
 Materiale: miscelatore in ottone cromato, doccetta in ABS cromato.
 Canna: forma a 155°, girevole, Ø35 mm, in ottone cromato.
 Altezza: 50 cm - Interasse: 23 cm.
Single-lever mixer for sink, with side lever, high J movable spout with pull-out hand shower, two functions.
 Material: mixer and spout in c.p. brass, hand shower in c.p. ABS.
 Spout: shape 155°, swivelling, Ø35 mm.
 Height: 50 cm - Interaxis: 23 cm.

S20680



Miscelatore monocomando laterale per lavello, alto, con bocca a U girevole.
 Materiale: miscelatore in ottone cromato.
 Canna: forma a 180°, girevole, Ø24 mm, in ottone cromato.
 Altezza: 33,5 cm - Interasse: 22 cm.
Single-lever mixer for sink, with side lever, high U movable spout.
 Material: mixer and spout in c.p. brass.
 Spout: shape 180°, swivelling, Ø24 mm.
 Height: 33,5 cm - Interaxis: 22 cm.



S20638

Miscelatore monocomando laterale per lavello, alto, con bocca girevole a molla in acciaio inox elettrolucidato, flessibile in acciaio inox ricoperto in pvc metallizzato e doccetta monogetto.
 Materiale: miscelatore in ottone cromato, con doccetta in ottone.
 Altezza: 42 cm - Interasse: 18 cm.
Single-lever mixer for sink, with side lever, high movable spring spout in stainless steel electro polished with shower.
 Material: mixer in c.p. brass, spout in stainless steel with stainless steel flexible covered with silver colour pvc, hand shower in c.p. brass.
 Height: 42 cm - Interaxis: 18 cm.

S20684



Miscelatore monocomando laterale per lavello alto, con bocca girevole a molla in acciaio inox elettrolucidato, flessibile e doccetta a due funzioni.
 Materiale: miscelatore in ottone cromato, molla in acciaio inox, flessibile in acciaio inox ricoperto in pvc metallizzato argento.
 Altezza: 72 cm - Interasse: 29,5 cm max.
Single-lever mixer for sink, with side lever, high movable spring spout in stainless steel electro polished with hand shower, two functions.
 Material: mixer in c.p. brass, spring spout in stainless steel with stainless steel flexible covered with silver colour pvc, hand shower in c.p. ABS.
 Height: 72 cm - Interaxis: 29,5 cm max.



S20681

Miscelatore monocomando laterale per lavello, alto, con doppia uscita dell'acqua e comando apertura-chiusura separato.
 Canna girevole in ottone cromato e bocca girevole a molla in acciaio inox elettrolucidato con flessibile e doccetta ad una funzione.
 Materiale: miscelatore in ottone cromato, molla in acciaio inox, flessibile in acciaio inox ricoperto in pvc metallizzato argento, doccetta in ABS cromato.
 Altezza: 72 cm - Interasse: 29,5 cm max.
Single-lever mixer for sink, with side lever, with double water outlet and opening/closing separate control. Lower movable spout in c.p. brass and high movable spring spout in stainless steel electro polished with hand shower, one function.
 Material: mixer in c.p. brass, high spout in spring in stainless steel with stainless steel flexible covered with silver colour pvc, hand shower in c.p. ABS.
 Height: 72 cm - Interaxis: 29,5 cm max.

MANIGLIE DISPONIBILI:
AVAILABLE HANDLES:



version A



version B



version C

OX23690C

Miscelatore monocomando laterale per lavello, alto, con bocca girevole e doccetta ad angolo retto estraibile a due funzioni. Materiale: miscelatore e bocca in ottone cromato, doccetta in ABS cromato. Canna: forma a 90°, girevole, Ø35 mm. Altezza: 31 cm - Interasse: 21 cm.
Single-lever mixer for sink, with side lever, high movable spout with 90° corner shaped pull-out hand shower, two functions.
Material: mixer and spout in c.p. brass, hand shower in c.p. ABS.
Spout: shape 90, swivelling, Ø35 mm.
Height: 31 cm - Interaxis: 21 cm.



OX23692C

Miscelatore monocomando laterale per lavello, alto, con bocca a C girevole e doccetta estraibile a due funzioni. Materiale: miscelatore in ottone cromato, doccetta in ABS cromato. Canna: forma a 180°, girevole, Ø35 mm, in ottone cromato. Interasse miscelatore: cm 20. Altezza: 51 cm - Interasse: 20 cm.
Single-lever mixer for sink, with side lever, high C movable spout with pull-out hand shower, two functions.
Material: mixer and spout in c.p. brass, hand shower in c.p. ABS.
Spout: shape 180°, swivelling, Ø35 mm.
Mixer interaxis: cm 20.
Height: 51 cm - Interaxis: 20 cm.



OX23694C

Miscelatore monocomando laterale per lavello, alto, con bocca girevole a molla in acciaio inox elettrolucidato, flessibile e doccetta estraibile a due funzioni. Materiale: miscelatore in ottone cromato, molla in acciaio inox, flessibile in acciaio inox ricoperto in pvc metallizzato argento, doccetta in ABS cromato. Altezza: 72 cm - Interasse: 29,5 cm max.
Single-lever mixer for sink, with side lever, high movable spring spout in stainless steel electro polished with pull-out hand shower, two functions.
Material: mixer in c.p. brass, spout in spring in stainless steel with stainless steel flexible covered with silver colour pvc, hand shower in c.p. ABS.
Height: 72 cm - Interaxis: 29,5 cm max.



OX23681C

Miscelatore monocomando laterale per lavello, alto, con doppia uscita dell'acqua e comando apertura-chiusura separato. Canna girevole in ottone cromato e bocca girevole a molla in acciaio inox elettrolucidato con flessibile e doccetta ad una funzione. Materiale: miscelatore in ottone cromato, molla in acciaio inox, flessibile in acciaio inox ricoperto in pvc metallizzato argento, doccetta in ABS cromato. Altezza: 72 cm - Interasse: 29,5 cm max.
Single-lever mixer for sink, with side lever, with double water outlet and opening/closing separate control. Lower movable spout in c.p. brass and high movable spring spout in stainless steel electro polished with hand shower, one function.
Material: mixer in c.p. brass, high spout in spring in stainless steel with stainless steel flexible covered with silver colour pvc, hand shower in c.p. ABS.
Height: 72 cm - Interaxis: 29,5 cm max.



OX23680C

Miscelatore monocomando laterale per lavello, alto, con bocca a U girevole. Materiale: miscelatore in ottone cromato. Canna: forma a 180°, girevole, Ø 24 mm, in ottone cromato. Altezza: 33,5 cm - Interasse: 22 cm.
Single-lever mixer for sink, with side lever, high a U movable spout.
Material: mixer and spout in c.p. brass.
Spout: shape 180°, swivelling, Ø 24 mm, in c.p. brass.
Height: 33,5 cm - Interaxis: 22 cm.



OX23638C

Miscelatore monocomando laterale per lavello, alto, con bocca girevole a molla in acciaio inox elettrolucidato, flessibile in acciaio inox ricoperto in pvc metallizzato e doccetta monogetto. Materiale: miscelatore in ottone cromato, doccetta in ottone cromato. Altezza: 42 cm - Interasse: 18 cm.
Single-lever mixer for sink, with side lever, high movable spring spout in stainless steel electro polished with shower.
Material: mixer in c.p. brass, spout in stainless steel with stainless steel flexible covered with silver colour pvc, hand shower in c.p. brass.
Height: 42 cm - Interaxis: 18 cm.



LAVELLI
SINKS

ACQUA
DEPURATA
PURIFIED
WATER

TOUCH-ME

COLOUR
AMBIENT

GOURMET



SENSOR

Le linee di rubinetteria a sensore Daniel si distinguono per eleganza e prestazioni. L'eleganza delle linee è garantita dall'accurato studio di design che sta alla base di ogni sviluppo.

L'ingegnerizzazione e produzione viene eseguita interamente in Italia dagli ingegneri e tecnici del Gruppo Daniel, tramite macchinari di ultimissima generazione, completamente automatizzati e robotizzati. Ogni pezzo è un gioiello di design e tecnologia delle costruzioni.

L'elettronica viene prodotta anch'essa in Italia da S.T.S.R.

Quando scegliete un miscelatore a sensore della linea Daniel, state puntando quindi su un prodotto studiato, ideato, creato con le migliori risorse del Made in Italy.

The sensor taps series of Daniel are distinguished by their elegance and performance. The elegance of the lines is guaranteed by the accurate design at the base of any development.

The engineering and manufacturing are performed entirely in Italy by engineers and technicians of Daniel Group, through machinery of the latest generation, fully automated and robotized. Every single piece is a jewel of design and construction technology.

The electronics and sensors are also produced in Italy from S.T.S.R.

When you choose a Daniel sensor mixer, you are indeed targeting a design product, created and developed with the best resources of the Made in Italy.





HI-TECH

SENSOR

TEMPOR
TOUCH

TEMPOR





SENL30018

Miscelatore elettronico lavabo ad azionamento a sensore, con luce led e con regolazione acqua calda/fredda, alimentato a batterie al litio.

Altezza: 23 cm - Interasse: 16 cm.

Sensor control basin mixer, with led light and with hot/cold water adjustment lever, powered by lithyum batteries.

Height: 23 cm - Interaxis: 16 cm.



SENL30118

Miscelatore elettronico lavabo ad azionamento a sensore, con luce led e con regolazione acqua calda/fredda, ad alimentazione elettrica.

Altezza: 23 cm - Interasse: 16 cm.

Sensor control basin mixer, with led light and with hot/cold water, adjustment lever, powered by electricity.

Height: 23 cm - Interaxis: 16 cm.



SENL634Q

Rubinetto lavabo ad incasso a sensore, monoacqua o premiscelata, con luce led, alimentato a batterie al litio.

Lunghezza bocca 13,1 cm.



Built in wash basin sensor mixer, single water or premixed, with led light, powered by lithyum batteries.

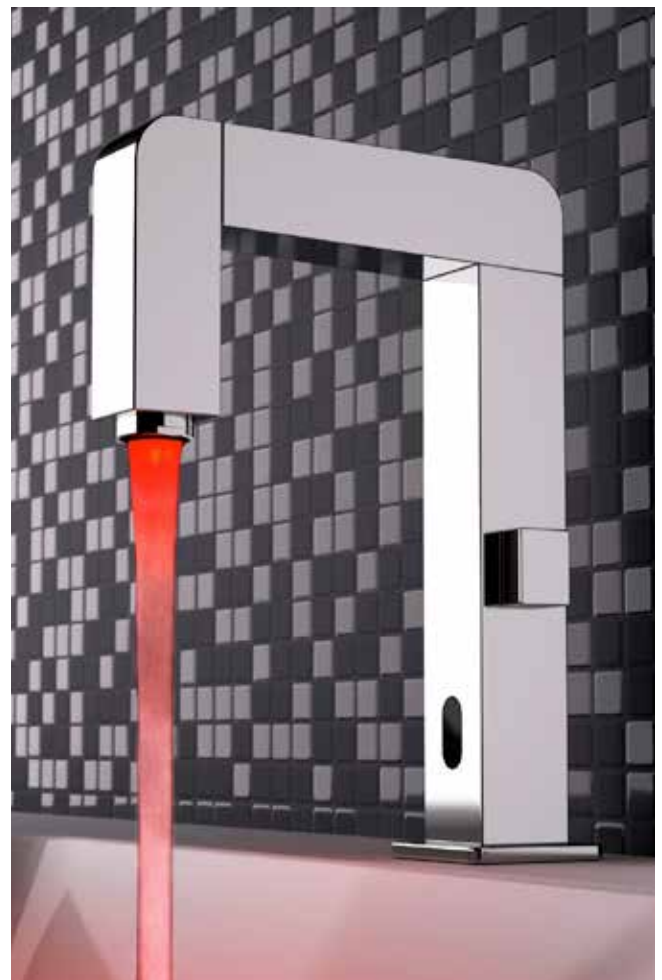

Length spout: 13,1 cm.









Rubinetto elettronico alto per lavabo con azionamento a sensore, dotato di due rubinetti sottolavabo con filtro.
Altezza: 30,3 cm - Interasse: 13,2 cm.
High electronic tap, with sensor control, equipped with two angle valves with filter.
Height: 30,3 cm - Interaxis: 13,2 cm.

SEN30017L per acqua premiscelata, alimentato a batterie al litio.
  for pre-mixed water, powered by lithium batteries.



SEN30117L per acqua premiscelata, ad alimentazione elettrica.
  for pre-mixed water, powered by electricity.



SEN30016L per mono-acqua, alimentato a batterie al litio.
  for single water, powered by lithium batteries.



SEN30116L per mono-acqua, ad alimentazione elettrica.
  for single water, powered by electricity.





Rubinetto elettronico per lavabo con azionamento a sensore, dotato di due rubinetti sottolavabo con filtro.
Altezza: 17,7 cm - Interasse: 13,1 cm.
Electronic tap, with sensor control, equipped with two angle valves with filter.
Height: 17,7 cm - Interaxis: 13,1 cm.

SEN30017 per acqua premiscelata, alimentato a batterie al litio.
  for pre-mixed water, powered by lithium batteries.

SEN30117 per acqua premiscelata, ad alimentazione elettrica.
  for pre-mixed water, powered by electricity.

SEN30016 per mono-acqua, alimentato a batterie al litio.
  for single water, powered by lithium batteries.

SEN30116 per mono-acqua, ad alimentazione elettrica.
  for single water, powered by electricity.



SEN634Q
Rubinetto lavabo ad incasso a sensore, monoacqua o premiscelata.
Lunghezza bocca 13,1 cm.
Built in wash basin sensor mixer, single water or premixed.
Length spout: 13,1 cm.



SEN634SK
Rubinetto lavabo ad incasso a sensore, monoacqua o premiscelata.
Lunghezza bocca 18,5 cm.
Built in wash basin sensor mixer, single water or premixed.
Length spout: 18,5 cm.

SENSOR

SEN30018

Miscelatore elettronico ad azionamento a sensore con regolazione acqua caldo/freddo tramite rubinetto sottolavabo, alimentato a batterie al litio.

Altezza: 23 cm - Interasse: 16 cm.

Sensor control basin mixer with hot/cold water adjustment lever on angle valves, powered by lithium batteries.

Height: 23 cm - Interaxis: 16 cm.



SEN30118

Miscelatore elettronico ad azionamento a sensore con regolazione acqua caldo/freddo tramite rubinetto sottolavabo, ad alimentazione elettrica.

Altezza: 23 cm - Interasse: 16 cm.

Sensor control basin mixer with hot/cold water adjustment lever on angle valves, powered by electricity.

Height: 23 cm - Interaxis: 16 cm.

SEN30025

Miscelatore elettronico ad azionamento a sensore con regolazione acqua caldo/freddo, alimentato a batterie al litio.

Altezza: 28,2 cm - Interasse: 21 cm.

Sensor control basin mixer with hot/cold water adjustment lever, powered by lithium batteries.

Height: 28,2 cm - Interaxis: 21 cm.



SEN30014

Rubinetto elettronico ad azionamento a sensore, alimentato a batterie al litio.

Altezza: 21 cm - Interasse: 14,5 cm.

Sensor control basin mixer, powered by lithium batteries.

Height: 21 cm - Interaxis: 14,5 cm.



SEN30014HC

Miscelatore elettronico ad azionamento a sensore con regolazione acqua caldo/freddo, alimentato a batterie al litio.

Altezza: 21 cm - Interasse: 14,5 cm.

Sensor control basin mixer with hot/cold water adjustment lever, powered by lithium batteries.

Height: 21 cm - Interaxis: 14,5 cm.

**SEN30014B**

Rubinetto elettronico ad azionamento a sensore, alimentato a batterie al litio.
Altezza: 21 cm - Interasse: 14,5 cm.
Sensor control basin mixer with basis, powered by lithyum batteries.
Height: 21 cm - Interaxis: 14,5 cm.

CE
**SEN30014BHC**

Miscelatore elettronico ad azionamento a sensore con regolazione acqua caldo/freddo, alimentato a batterie al litio.
Altezza: 21 cm - Interasse: 14,5 cm.
Sensor control basin mixer with hot/cold water adjustment lever with basis, powered by lithyum batteries.
Height: 21 cm - Interaxis: 14,5 cm.

CE

SENSOR

**SEN30033**

Rubinetto esterno elettronico per orinatoio.
External urinal electronic flusher.

**SEN30030**

Rubinetto ad incasso elettronico per orinatoio.
Built-in urinal electronic flusher.

TEMPOR
TOUCH

TEMPOR

**SENPKIT**

Kit composto da: connettore per alimentazione elettrica dei dispositivi elettronici, con commutazione automatica a batteria in caso di mancanza energia elettrica ed alimentatore a 6V, in scatola (da utilizzare con batterie alcaline).

Kit composed of: power supply jointer with battery back-up function and power supply 6V, in box (for use owith alkaline batteries)..

CE



TEMPOR
TEMPOR
T O U C H





HI-TECH

SENSOR

TEMPOR
TOUCH

TEMPOR





TEMT17

Rubinetto a temporizzazione elettronica con attivazione tramite pulsante ad azionamento piezoelettrico alimentato a batteria, minimale quadrato, in ottone cromato, tempo d'apertura circa 10 secondi.

Altezza: 16 cm - interassa: 10,8 cm.
Electronic timing pillar tap with piezoelectric activation button, batteries powered, minimal squared shape, all in c.p. brass, opening time about 10 seconds.
 Height: 16 cm - Interaxis: 10,8 cm.



TEMT10

Rubinetto a temporizzazione elettronica con attivazione tramite pulsante ad azionamento piezoelettrico alimentato a batteria, minimale tondo, in ottone cromato, tempo d'apertura circa 10 secondi.

Altezza: 15,5 cm - interassa: 10,8 cm.
Electronic timing pillar tap with piezoelectric activation button, batteries powered, minimal round shape, all in c.p. brass, opening time about 10 seconds.
 Height: 15,5 cm - Interaxis: 10,8 cm.



TEMT217

Rubinetto a temporizzazione elettronica con attivazione tramite pulsante ad azionamento piezoelettrico alimentato a batteria, minimale quadrato, in ottone cromato, a due tempi d'apertura: primo tempo circa 10 secondi, secondo tempo circa 20 secondi.

Altezza: 16 cm - interassa: 10,8 cm.
Electronic timing pillar tap with piezoelectric activation button, batteries powered, minimal squared shape, all in c.p. brass, two times opening: first time opening about 10 seconds, second time about 20 seconds.
 Height: 16 cm - Interaxis: 10,8 cm.



TEMT210

Rubinetto a temporizzazione elettronica con attivazione tramite pulsante ad azionamento piezoelettrico alimentato a batteria, minimale tondo, in ottone cromato, a due tempi d'apertura: primo tempo 10 secondi, secondo tempo 20 secondi.

Altezza: 15,5 cm - interassa: 10,8 cm.
Electronic timing pillar tap with piezoelectric activation button, batteries powered, minimal round shape, all in c.p. brass, two times opening: first time opening about 10 seconds, second time about 20 seconds.
 Height: 15,5 cm - Interaxis: 10,8 cm.



LAVELLO ELETTRONICO TEMPORIZZATO - TEMPORIZED ELECTRONIC SINK MIXER



SENSOR

TEMPOR
TOUCH

TEMPOR

Nei miscelatori con gestione elettronica, grazie al pulsante piezoelettrico posizionato sulla sommità, è sufficiente una leggera pressione per gestire l'erogazione dell'acqua depurata o l'utilizzo dell'acqua destinata agli elettrodomestici.

In the electronically controlled mixers, thanks to the piezoelectric button positioned on the top, it is enough a light pressure to manage the purified water supply or enable water supply for household appliances.

**TEMT608QDW**

Miscelatore lavello quadrato a tre vie di ingresso, bocca girevole, con selezione acqua potabile tramite pulsante ad azionamento piezoelettrico alimentato a batteria, con 2 aeratori in uscita.

Altezza: 29,5 cm - Interasse: 21,5 cm.

Three ways inlet squared single lever sink mixer, with movable spout, with selection for drinking water with piezoelectric activation button, batteries powered, with 2 exit aerators.

Height: 29,5 cm - Interaxis: 21,5 cm.

LITHIUM CE

**TEMT608DW**

Miscelatore lavello minimale a tre vie di ingresso, bocca girevole, con selezione acqua potabile tramite pulsante ad azionamento piezoelettrico alimentato a batteria, con 2 aeratori in uscita.

Altezza: 29,5 cm - Interasse: 21,5 cm.

Three ways inlet minimal single lever sink mixer, with movable spout, with selection for drinking water with piezoelectric activation button, batteries powered, with 2 exit aerators.

Height: 29,5 cm - Interaxis: 21,5 cm.

LITHIUM CE

**TEMT608QWM**

Miscelatore monocomando quadrato per lavello con tasto elettronico di sicurezza per la temporizzazione dell'acqua alla lavatrice/lavastoviglie. Chiusura automatica dell'acqua all'elettrodomestico dopo 3 o 12 ore (doppia temporizzazione).

Altezza: 29,8 cm - Interasse: 21,4 cm.

Squared design single-lever mixer with electronic safety button for timing the water opening at the washing machine/dishwasher.

Automatic closure of water to the appliance after 3 or 12 hours (double timing)

Height: 29,8 cm - Interaxis: 21,4 cm.

LITHIUM CE

**TEMT608WM**

Miscelatore monocomando per lavello, con tasto elettronico di sicurezza per la temporizzazione dell'acqua alla lavatrice/lavastoviglie. Chiusura automatica dell'acqua all'elettrodomestico dopo 3 o 12 ore (doppia temporizzazione).

Altezza: 29,5 cm - Interasse: 21,5 cm.

Single-lever mixer with electronic safety button for timing the water opening at the washing machine/dishwasher.

Automatic closure of water to the appliance after 3 or 12 hours (double timing)

Height: 29,5 cm - Interaxis: 21,5 cm.

LITHIUM CE



RUBINETTI TEMPORIZZATI - TEMPORIZED TAPS



TEM40010M

Rubinetto miscelatore temporizzato a collo di cigno con maniglia per la selezione dell'acqua calda/fredda, 1/2" in ottone cromato, tempo di apertura 6-8 secondi.
 Altezza: 13 cm - Interasse 11 cm.
*Temporized mixer pillar tap with hot/cold water selection handle, in c.p. brass, opening time 6-8 seconds.
 Height: 13 cm - interaxis: 11 cm.*



TEM40011M

Rubinetto miscelatore temporizzato con miscelazione tramite vitone a collo di cigno con maniglia per la selezione dell'acqua calda/fredda, in ottone cromato, tempo di apertura 6-8 secondi.
 Altezza: 13 cm - Interasse 11 cm.
*Temporized mixer with water mixing through headvalve, pillar tap with hot/cold water selection handle, 1/2" in c.p. brass, opening time 6-8 seconds.
 Height: 13 cm - interaxis: 11 cm.*



TEM40010

Rubinetto temporizzato 1/2" in ottone cromato tempo d'apertura 6-8 secondi.
 Altezza: 13 cm - Interasse 11 cm.
*Temporized tap 1/2 all in Cp brass opening time 6-8 seconds.
 Height: 13 cm - interaxis: 11 cm.*



TEM40017

Rubinetto temporizzato 1/2" in ottone cromato tempo d'apertura 6-8 secondi.
 Altezza: 15 cm - Interasse 11,5 cm.
*Temporized tap 1/2 all in Cp brass opening time 6-8 seconds.
 Height: 15 cm - interaxis: 11,5 cm.*



TEM40012

Rubinetto temporizzato 1/2" in ottone cromato tempo d'apertura 6-8 secondi.
 Altezza: 16,5 cm - Interasse 12 cm.
*Temporized tap 1/2 all in Cp brass opening time 6-8 seconds.
 Height: 16,5 cm - interaxis: 12 cm.*



TEM40018

Rubinetto temporizzato 1/2" in ottone cromato tempo d'apertura 6-8 secondi.
 Altezza: 13 cm - Interasse 10,5 cm.
*Temporized tap 1/2 all in Cp brass opening time 6-8 seconds.
 Height: 13 cm - interaxis: 10,5 cm.*

**TEM40016**

Rubinetto temporizzato 1/2" in ottone cromato tempo d'apertura 6-8 secondi.
Altezza: 11 cm - Interasse 12 cm.
*Temporized tap 1/2 all in Cp brass opening time 6-8 seconds.
Height: 11 cm - interaxis: 12 cm.*

**TEM40015**

Rubinetto temporizzato 1/2" in ottone cromato tempo d'apertura 6-8 secondi.
Altezza: 9,5 cm - Interasse 10,5 cm.
*Temporized tap 1/2 all in Cp brass opening time 6-8 seconds.
Height: 9,5 cm - interaxis: 10,5 cm.*

**TEM40225**

Rubinetto a muro temporizzato 1/2" in ottone cromato tempo d'apertura 6-8 secondi.
Temporized frontal mounted 1/2 tap all in Cp brass, opening time 6-8 seconds.

**TEM40053**

Rubinetto frontale temporizzato con canna S 3/4" in ottone cromato tempo d'apertura 6-8 secondi.
Temporized frontal mounted mixer with "S" spout, 3/4" all in Cp brass opening time 6-8 seconds.

**TEM40053J**

Rubinetto superiore temporizzato, con canna "J", 1/2", in ottone cromato, tempo d'apertura 6-8 secondi.
Temporized (timer) upper mounted, with "J" spout, 1/2" tap, all in c.p. brass, opening time 6-8 seconds.

**TEM40053U**

Rubinetto superiore temporizzato, con canna "U" 1/2", in ottone cromato, tempo d'apertura 6-8 secondi.
Temporized (timer) upper mounted, with "U" spout, 1/2" tap, all in c.p. brass, opening time 6-8 seconds.

SENSOR

TEMPOR
TOUCH

TEMPOR

TOILET TEMPORIZZATI - TEMPORIZED TOILET

**TEM40171**

Flussometro temporizzato a incasso con piastra tonda a pulsante per WC 3/4 o 1", tempo d'apertura 6-8 secondi.
Temporized built-in tap for WC with round plate 3/4 or 1", opening time 6-8 seconds.

**TEM40171Q**

Flussometro temporizzato a incasso con piastra rettangolare a pulsante per WC 3/4 o 1", tempo d'apertura 6-8 secondi.
Temporized built-in tap for WC with rectangular plate 3/4 or 1", opening time 6-8 seconds.

**1000TEM**

Set "Oasis" composto da: doccia a pulsante art. 1000DC, flex. conico cm 120 rubinetto temporizzato 1/2" in ottone cromato tempo d'apertura 15-25 secondi.
"Oasis" set composed of: shut-off handshower Art. 1000DC, flex. cm 120, temporized button flusher 1/2" all in Cp brass, opening time 15-25 seconds.

**A1515TEM**

Set composto da: idroscopino a pulsante in ottone cromato, flessibile conico cm 120, rubinetto temporizzato 1/2" in ottone cromato, tempo d'apertura 6-8 secondi.
Set composed by: hydro brush in c.p. brass, flexible cm 120, temporized button flusher 1/2" all in c.p. brass, opening time 6-8 seconds.

**TEM40170**

Flussometro temporizzato esterno a pulsante per WC C 3/4" o 1", in ottone cromato, tempo d'apertura 5-6 secondi.
Temporized wall mounted tap for WC 3/4 or 1", all in C.p. brass, opening time 5-6 seconds.

**TEM40030VI**

Cartuccia di ricambio per TEM40855, TEM40053.
Cartridge for temporized taps for TEM40855, TEM40053.

**TEM40001**

Cartuccia di ricambio per TEM40015, TEM40016, TEM40225, TEM40855, TEM40053.
Cartridge for temporized taps for TEM40015, TEM40016, TEM40225, TEM40855, TEM40053.

TEMPOR



TEM40855

Rubinetto per orinatoio temporizzato 1/2" in ottone cromato tempo d'apertura 6-8 secondi.

Temporized urinal button flusher 1/2 all in Cp brass, opening time 6-8 seconds.



TEM40860

Rubinetto per orinatoio temporizzato 1/2" in ottone cromato tempo d'apertura 6-8 secondi.

Temporized urinal button flusher 1/2 all in Cp brass, opening time 6-8 seconds.



TEM40170TB

Tubo a "L" per flussometro esterno in ottone cromato Ø 25, 30.

"L" cp brass pipe for wall mounted temporized tap for WC Ø .25, 30.



A40860

Spartiacque per orinatoio, attacco e tubo Ø15 mm.

Water divide for urinals, connector and pipe Ø15 mm.

DOCCIA TEMPORIZZATI - TEMPORIZED SHOWER

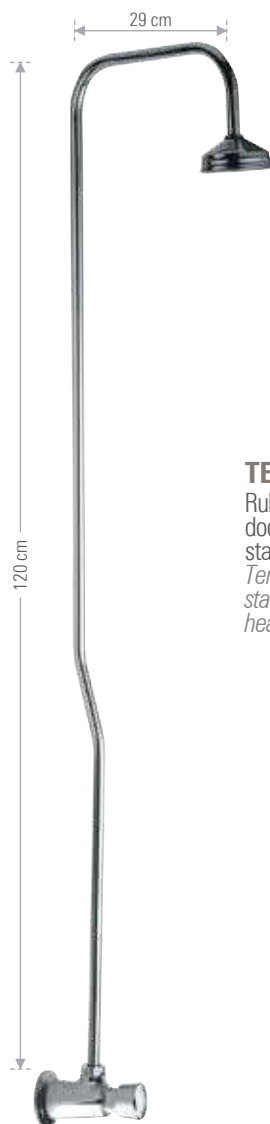

TEM40053AS

Rubinetto frontale temporizzato, colonna doccia 1/2" x 3/4" e soffione doccia standard, tempo d'apertura 6-8 secondi.

Temporized (timer) frontal mounted, with stand pipe 1/2" x 3/4" and standard shower head, opening time 6-8 seconds.



TEM40035

Rubinetto temporizzato per doccia esterno 1/2"x1/2" in ottone cromato, tempo d'apertura 18-20 secondi.

Temporized tap for shower 1/2"x1/2" external all in C.p. brass, opening time 18-20 seconds.



TEM40030

Rubinetto temporizzato per doccia incasso 1/2 con piastra tonda, tempo d'apertura 18-20 secondi.

Temporized wall mounted tap 1/2 with round plate, opening time 18-20 seconds.



TEM40030Q

Rubinetto temporizzato per doccia incasso 1/2 con piastra rettangolare, tempo d'apertura 18-20 secondi.

Temporized wall mounted tap 1/2 with rectangular plate, opening time 18-20 seconds.

SOFFIONI ANTIMPICCAGIONE - HEADSHOWERS ANTLIGATURE

**A560AV**

Soffione doccia antivandalo ed antimpiccagione con getto regolabile.
Antivandal and antiligatures shower head with adjustable spray.

**A560AVS**

Soffione doccia antivandalo ed antimpiccagione con getto fisso.
Antivandal and antiligatures shower head with fix spray.

SENSORTEMPOR
TOUCHTEMPOR



WELLNESS





WELLNESS

BOX
INCASSO
BUILT-IN
BOX

WELLNESS
KIT

CROMOTERAPIA
COLOUR
THERAPIE

SOFFIONI
SHOWER
HEAD

PANNELLI
DOCCIA
SHOWER
PANELS

COLONNE
DOCCIA
SHOWER
COLUMN

SALISCENDI
SLIDING
RAILS

DOCCETTE
HAND
SHOWERS

OASIS
SHUT-OFF

BOCCE
SPOUTS

ACCESSORI
RUBINETTERIA
TAP
ACCESSORIES



BOX INCASSO - BUILT-IN BOX

per miscelatore vasca-doccia con deviatore

for bath-shower mixer with diverter

Le BOX INCASSO di Daniel Rubinetterie sono un articolo **studiato appositamente per le esigenze di cantiere.**

A differenza delle proposte tradizionali, **permettono infatti di incassare una parte murata neutra e compatibile con tutte le diverse serie di Daniel Rubinetterie.**

In questo modo è possibile concludere i lavori di tracciatura e muratura in totale libertà e senza interruzioni. **L'installazione potrà essere completata in un secondo momento** con le parti esterne della rubinetteria che sceglierà il Vostro Cliente.

Le BOX INCASSO sono predisposte per alloggiare tutte le nostre serie di miscelatori con:

- A) cartuccia termostatica
- B) cartuccia da 40 mm
- C) cartuccia da 35 mm

BUILT-IN BOX by Daniel Rubinetterie **is an item specifically designed for the construction sites needs.**

Compared with the traditional built-in mixer with diverter, the **boxes allow to embed a neutral walled part that is compatible with all the different series of Daniel Rubinetterie.**

In this way it is possible to complete construction works in total freedom and without interruptions. **Installations can be completed at a later time** with the external parts of the faucet Collection chosen by Your Customers.

The box has been specially designed to **set all our mixers collections** with:

- A) thermostatic cartridge
- B) 40 mm cartridge
- C) 35 mm cartridge



A cartuccia termostatica
thermostatic cartridge

B cartuccia da 40 mm
40 mm cartridge

C cartuccia da 35 mm
35 mm cartridge

Durante i lavori di costruzione sarà necessario **definire la BOX a incasso solo in base al numero di uscite d'acqua previste dal progetto.**

Una soluzione versatile, pratica e funzionale che velocizza gli interventi di costruzione, ristrutturazione e manutenzione e che offre ai Vostri Clienti il valore aggiunto della personalizzazione senza impattare sui tempi.

Utilizzando il codice DANBOX (BOX INCASSO PER MISCELATORE VASCA-DOCCIA) potranno essere gestite tutte le combinazioni che prevedono 1 (o nessuna) deviazione.

Quindi ad esempio:

- bocca a parete+ saliscendi
- saliscendi + soffione doccia
- bocca per vasca + soffione
- soffione + getti doccia
- saliscendi + getti doccia
- bocca a parete+ getti doccia

La BOX INCASSO di Daniel Rubinetterie e tutti i suoi componenti sono interamente prodotti in Italia utilizzando i migliori materiali e tecnologie produttive high-tech.

La materia prima utilizzata per il contenitore della BOX, ad alta densità, è stata appositamente selezionata per essere pratica al taglio, durevole nel tempo, protettiva, resistente e insonorizzante.

Grazie al ridotto spessore delle BOX di Daniel Rubinetterie è possibile l'installazione in cartongessi e pareti in legno. Il prodotto è sempre ispezionabile nel tempo.

During construction works You only need **to define the BOX model basing on the number of water exits defined in Your project.**

A versatile, practical and functional solution that speeds up construction, renovation and maintenance interventions and that offers to Your Customers the added value of customization, without impacting on time planning.

The code DANBOX (BUILT-IN BOX FOR BATH AND SHOWER MIXER) can manage all combinations with 1 (or none) deviation.

For example:

- wall spout + sliding rail
- sliding rail + shower head
- wall spout + shower head
- shower head + shower jets
- sliding rail + shower jets
- wall spout + shower jets

Daniel Rubinetterie built-in box and all of its components are entirely produced in Italy using the finest materials and high-tech production technologies.

The raw material used for Daniel built-in box cover, in high density, has been specially selected to be practical to cutting, long-lasting, protective and safe and give further noise insulation.

Thanks to the slim thickness of the DAN BOX, it is possible to also install it in wooden walls and/or drywalls. The product is always inspectionable in time.



Cod. DAN BOX

Una volta installata la vostra DANIEL BOX

Potrete nel tempo scegliere il kit più adatto alle vostre esigenze e ai vostri gusti tra i seguenti kit doccia con deviatore, corrispondenti ciascuno alle diverse collezioni di Daniel rubinetterie.
Nel caso in cui il Cliente finale desideri non sfruttare le due uscite è possibile adattare la DAN BOX per diventare un incasso semplice, non più con deviatore ma a singola uscita.

Once installed your DANIEL BOX

During time You can choose the shower kit that best suits your needs and your tastes from the following ones with diverter, each one corresponding to different collections from Daniel rubinetterie.
In the event that the end customer does not want to exploit the two outputs, it is possible to adapt the DAN BOX in order to become a built-in mixer with a single output and no longer with a diverter.

CARTUCCIA Ø 35 - Ø 35 CARTRIDGE

MINI	TOKYO	SUVI	SMART	REVIVAL	RETRO	FUSION
MT16612KB	TK612KB	S20612KB	SR612KB	V612KB	RT612KB	FU612KB
MT16602KB	TK602KB	S20602KB	SR602KB	V602KB	RT602KB	FU602KB

OMEGA	DIVA	TIARA	SPEED	SKYLINE	OXY-CUBE WATERFALL
OM612KB	DV612KB	TA612KB	SP612KB	SK612KB	OX23612KB
OM602KB	DV602KB	TA602KB	SP602KB	SK602KB	OX23602KB

CARTUCCIA Ø 40 - Ø 40 CARTRIDGE

RIO	SERENA	VENUS	CONTRACT	ECO
R6612KB	SA1612KB	VE13612KB	CT13612KB	ES5612KB
R6602KB	SA1602KB	VE13602KB	CT13602KB	ES5602KB

CARTUCCIA TERMOSTATICA - THERMOSTATIC CARTRIDGE

SKYLINE THERMO - OXY THERMO		SUVI THERMO	
SKT602KB	SKT612KB	ST20602KB	ST20612KB

BOX
INCASSO
BUILT-IN
BOXWELLNESS
KITCROMOTERAPIA
COLOUR
THERAPIESOFFIONI
SHOWER
HEADPANNELLI
DOCCIA
SHOWER
PANELSCOLONNE
DOCCIA
SHOWER
COLUMNSALISCENDI
SLIDING
RAILSDOCCETTE
HAND
SHOWERSOASIS
SHUT-OFFBOCCHE
SPOUTSACCESSORI
RUBINETTERIA
TAP
ACCESSORIES

BOX INCASSO - BUILT-IN BOX

per miscelatore vasca-doccia con deviatore
a dischi ceramici a 2 o 3 posizioni

for bath-shower mixer with diverter
ceramic discs diverter 2 or 3 positions.

Le BOX INCASSO di Daniel Rubinetterie sono un articolo **studiato appositamente per le esigenze di cantiere.**

A differenza delle proposte tradizionali, **permettono infatti di incassare una parte murata neutra e compatibile con tutte le diverse serie di Daniel Rubinetterie.**

In questo modo è possibile concludere i lavori di tracciatura e muratura in totale libertà e senza interruzioni.

L'installazione potrà essere completata in un secondo momento con le parti esterne della rubinetteria che sceglierà il Vostro Cliente.

Le BOX INCASSO sono predisposte per alloggiare tutte le nostre serie di miscelatori con:

- A) cartuccia termostatica
- B) cartuccia da 40 mm
- C) cartuccia da 35 mm

BUILT-IN BOX by Daniel Rubinetterie **is an item specifically designed for the construction sites needs.**

Compared with the traditional built-in mixer with diverter, the **boxes allow to embed a neutral walled part that is compatible with all the different series of Daniel Rubinetterie.**

In this way it is possible to complete construction works in total freedom and without interruptions. **Installations can be completed at a later time** with the external parts of the faucet Collection chosen by Your Customers.

The box has been specially **designed to set all our mixers collections** with:

- A) thermostatic cartridge
- B) 40 mm cartridge
- C) 35 mm cartridge



Durante i lavori di costruzione sarà necessario definire la BOX a incasso solo in base al numero di uscite d'acqua previste dal progetto.

Una soluzione versatile, pratica e funzionale che velocizza gli interventi di costruzione, ristrutturazione e manutenzione e che offre ai Vostri Clienti il valore aggiunto della personalizzazione senza impattare sui tempi.

Utilizzando il codice DANBOXD2 (BOX INCASSO DEVIATORE A 2 POSIZIONI) potranno essere installate le tutte le combinazioni a due uscite descritte nella pagina precedente.

Utilizzando il codice DANBOXD3 (BOX INCASSO DEVIATORE A 3 POSIZIONI) potranno invece essere gestite tutte le combinazioni che prevedono 3 uscite, come ad esempio:

- bocca a parette + saliscendi + soffione
- saliscendi + soffione pioggia + soffione cascata
- bocca a parette + soffione pioggia + soffione cascata
- soffione doccia + getti doccia + doccetta
- bocca a parete + getti doccia + saliscendi

La BOX INCASSO di Daniel Rubinetterie e tutti i suoi componenti sono interamente prodotti in Italia utilizzando i migliori materiali e tecnologie produttive high-tech.

La materia prima utilizzata per il contenitore della BOX, ad alta densità, è stata appositamente selezionata per essere pratica al taglio, durevole nel tempo, protettiva, resistente e insonorizzante.

Grazie al ridotto spessore delle BOX di Daniel Rubinetterie è possibile l'installazione in cartongessi e pareti in legno.

Il prodotto è sempre ispezionabile nel tempo.

During construction works You only need to define the BOX model to built-in basing on the number of water exits defined in Your project.

A versatile, practical and functional solution that speeds up construction, renovation and maintenance interventions and that offers to Your Customers the added value of customization, without impacting on time planning.

Code DANBOXD2 (2-POSITIONS DEVIATOR BOX) all the two-output combinations described on the previous page can be installed.

Code DANBOXD3 (3-POSITIONS DEVIATOR BOX) can manage 3 exits, such as:

- wall spout + sliding rail + shower head
- sliding rail + shower head rain jet + showerhead waterfall jet
- wall spout + shower head rain jet + showerhead waterfall jet
- shower head + shower jets + sliding rail
- wall spout + shower jets + sliding rail

Daniel Rubinetterie built-in box and all of its components are entirely produced in Italy using the finest materials and high-tech production technologies.

The raw material used for Daniel built-in box cover, in high density, has been specially selected to be practical to cutting, long-lasting, protective and safe and give further noise insulation.

Thanks to the slim thickness of the DAN BOX, it is possible to also install it in wooden walls and/or drywalls.

The product is always inspectionable in time.



Cod. DAN BOXD2
Box da incasso per
miscelatore doccia
due vie.

Built-in box for two
ways shower mixer.



Cod. DAN BOXD3
Box da incasso per
miscelatore doccia
tre vie.

Built-in box for three
ways shower mixer.

Una volta installata la
vostra DANIEL BOX

Potrete nel tempo scegliere
il kit piú adatto alle vostre es-
igenze e ai vostri gusti tra i
seguenti kit doccia con devia-
tore, corrispondenti ciascuno a
una linea di rubinetteria Daniel

Once installed your
DANIEL BOX

You will have the chance,
in time, to finish your set
by choosing the line and
functionality you prefer,
within the full choice below,
each one corresponding to a
Daniel mixers.

INCASSI CON DAN BOXD2 - BUILT-IN WITH DAN BOXD2

TOKYO	SUVI	SMART	FUSION	OMEGA	DIVA
TK612D2KB	S20612D2KB	SR612D2KB	FU612D2KB	OM612D2KB	DV612D2KB
TIARA	SPEED	SKYLINE	OXY CUBE WATERFALL	SKYLINE THERMO OXY THERMO	SUVI THERMO
TA612D2KB	SP612D2KB	SK612D2KB	OX23612D2KB	SKT612D2KB	ST20612D2KB

BOX
INCASSO
BUILT-IN
BOX

WELLNESS
KIT

CROMOTERAPIA
COLOUR
THERAPIE

SOFFIONI
SHOWER
HEAD

INCASSI CON DAN BOXD3 - BUILT-IN WITH DAN BOXD3

SET 3 VIE - 3 WAYS SET

TOKYO	SUVI	SMART	FUSION	OMEGA	DIVA
TK612D3KB	S20612D3KB	SR612D3KB	FU612D3KB	OM612D3KB	DV612D3KB
TIARA	SPEED	SKYLINE	OXY CUBE WATERFALL	SKYLINE THERMO OXY THERMO	SUVI THERMO
TA612D3KB	SP612D3KB	SK612D3KB	OX23612D3KB	SKT612D3KB	ST20612D3KB

PANNELLI
DOCCIA
SHOWER
PANELS

COLONNE
DOCCIA
SHOWER
COLUMN

SALISCENDI
SLIDING
RAILS

DOCCETTE
HAND
SHOWERS

SET 3 VIE E 7 POSIZIONI - 3 WAYS AND 7 POSITIONS SET

TOKYO	SUVI	SMART	FUSION	OMEGA	DIVA
TK612D7KB	S20612D7KB	SR612D7KB	FU612D7KB	OM612D7KB	DV612D7KB
TIARA	SPEED	SKYLINE	OXY CUBE WATERFALL	SKYLINE THERMO OXY THERMO	SUVI THERMO
TA612D7KB	SP612D7KB	SK612D7KB	OX23612D7KB	SKT612D7KB	ST20612D7KB

OASIS
SHUT-OFF

BOCCHE
SPOUTS

ACCESSORI
RUBINETTERIA
TAP
ACCESSORIES

BOX INCASSO - BUILT-IN BOX

per miscelatore lavabo a parete. for built-in basin mixer

Le BOX INCASSO di Daniel Rubinetterie sono un articolo studiato appositamente per le esigenze di cantiere.

Le BOX, a differenza delle proposte tradizionali, permettono infatti di incassare una parte murata neutra e compatibile con tutte le diverse serie di Daniel Rubinetterie.

In questo modo è possibile concludere i lavori di tracciatura e muratura in totale libertà e senza interruzioni.

L'installazione potrà essere completata in un secondo momento con le parti esterne della rubinetteria che sceglierà il Vostro Cliente.

BUILT-IN BOX by Daniel Rubinetterie is an item specifically designed for the construction sites needs.

Compared with the traditional built-in mixer with diverter, the boxes allow to embed a neutral walled part that is compatible with all the different series of Daniel Rubinetterie.

In this way it is possible to complete construction works in total freedom and without interruptions. Installations can be completed at a later time with the external parts of the faucet Collection chosen by Your Customers.



DANBOX632 (BOX INCASSO PER MISCELATORE LAVABO A PARETE) è predisposta per alloggiare i modelli di miscelatore per lavabo a muro di tutte le collezioni Daniel Rubinetterie.

Una soluzione versatile, pratica e funzionale che velocizza gli interventi di costruzione, ristrutturazione e manutenzione e che offre ai Vostri Clienti il **valore aggiunto della personalizzazione senza impattare sui tempi e sullo stato dei lavori.**

La BOX INCASSO di Daniel Rubinetterie e tutti i suoi componenti sono interamente prodotti in Italia utilizzando i migliori materiali e tecnologie produttive high-tech.

La materia prima utilizzata per il contenitore della BOX, ad alta densità, è stata appositamente selezionata per essere pratica al taglio, durevole nel tempo, protettiva, resistente e insonorizzante.

Grazie al ridotto spessore delle BOX di Daniel Rubinetterie è possibile l'installazione in cartongessi e pareti in legno.

Il prodotto è sempre ispezionabile nel tempo.

DANBOX632 (BUILT-IN BOX FOR WALL MONTED BASIN MIXERS) is designed to set wall mounted basin mixer models from all the collections by Daniel Rubinetterie.

A versatile, practical and functional solution that speeds up construction, renovation and maintenance interventions and that offers to Your Customers **the added value of customization, without impacting on time planning.**

Daniel Rubinetterie built-in box and all of its components are entirely produced in Italy using the finest materials and high-tech production technologies.

The raw material used for Daniel built-in box cover, in high density, has been specially selected to be practical to cutting, long-lasting, protective and safe and give further noise insulation.

Thanks to the slim thickness of the DAN BOX, it is possible to also install it in wooden walls and/or drywalls.

The product is always inspectionable in time.

**Cod. DAN BOX632**

Box da incasso per miscelatore lavabo.

Built-in box for built-in basin mixer.











Una volta installata la vostra DANIEL BOX

Potrete nel tempo scegliere il kit più adatto alle vostre esigenze e ai vostri gusti tra i seguenti kit lavabo a parete, corrispondenti ciascuno a linee di rubinetteria Daniel.

Once installed your DANIEL BOX

You will have the chance, in time, to finish your set by choosing the line and functionality you prefer, within the full choice below, each one corresponding to a Daniel mixers.

BOX
INCASSO
BUILT-IN
BOX

<p>DIVA</p>  <p>DV632KB</p>	<p>FUSION</p>  <p>FU632KB</p>	<p>OMEGA</p>  <p>OM632KB</p>
<p>SUVI</p>  <p>S20632KB</p>	<p>SKYLINE</p>  <p>SK632KB</p>	<p>SPEED</p>  <p>SP632KB</p>
<p>SMART</p>  <p>SR632KB</p>	<p>TIARA</p>  <p>TA632KB</p>	<p>TOKYO</p>  <p>TK632KB</p>
<p>OXY</p>  <p>OX23632KB</p>		

WELLNESS
KITCROMOTERAPIA
COLOUR
THERAPIESOFFIONI
SHOWER
HEADPANNELLI
DOCCIA
SHOWER
PANELSCOLONNE
DOCCIA
SHOWER
COLUMNSALISCENDI
SLIDING
RAILSDOCCETTE
HAND
SHOWERSOASIS
SHUT-OFFBOCCE
SPOUTSACCESSORI
RUBINETTERIA
TAP
ACCESSORIES



WELLNESS KIT





WELLNESS

BOX
INCASSO
BUILT-IN
BOX

WELLNESS
KIT

CROMOTERAPIA
COLOUR
THERAPIE

SOFFIONI
SHOWER
HEAD

PANNELLI
DOCCIA
SHOWER
PANELS



COLONNE
DOCCIA
SHOWER
COLUMN

SALISCENDI
SLIDING
RAILS

DOCCETTE
HAND
SHOWERS

OASIS
SHUT-OFF

BOCCH
SPOUTS

ACCESSORI
RUBINETTERIA
TAP
ACCESSORIES



Set doccia composto da:
Art. SSA578 SSA555L: Soffione doccia ultra piatto e braccio tutto in acciaio INOX spazzolato.

Art. SSA335 SSA435 con SSA516150: Saliscendi minimale con doccetta tutto in acciaio INOX spazzolato e flessibile conico in pvc color grigio acciaio.

Art. SSA520: presa acqua tipo rotondo in acciaio INOX spazzolato.

Art. SSTX612D2P: Miscelatore per doccia con deviatore a 2 posizioni in acciaio INOX spazzolato.

Shower set composed by:
Art. SSA578CM20 SSA555LCM30: ultra slim shower head with arm all in brushed stainless steel.

Art. SSA335 SSA435 with SSA516150: Minimal sliding bar with minimal handshower, completely in brushed stainless steel with shower flexible hose in pvc steel grey colour cm 150.

Art. SSA520: wall connector, round in brushed stainless steel.

Art. SSTX612D2P: brushed stainless steel shower mixer, with 2 positions diverter.

SSTX614ZD2P7820

Disponibile con soffione da cm Ø20 cm e braccio a parete 30 cm.
Available with head shower cm Ø20 cm and wall arm 30 cm.

SSTX614ZD2P7825

Disponibile con soffione da cm Ø25 cm e braccio a parete da 30 cm.
Available with head shower cm Ø25 cm and wall arm 30 cm.

SSTX614ZD2P7830

Disponibile con soffione da cm Ø30 cm e braccio a parete da 30 cm.
Available with head shower cm Ø30 cm and wall arm 30 cm.

SSTX614SD2P7820

Disponibile con soffione da cm Ø20 cm e braccio a soffitto da 30 cm.
Available with head shower cm Ø20 cm and ceiling arm 30 cm.



Set doccia composto da:
Art. SSA578 SSA555L: Soffione doccia ultra piatto e braccio tutto in acciaio INOX spazzolato.

Art. SSA546 SSA435 con SSA516150: supporto lusso con presa acqua e doccetta tutto in acciaio INOX spazzolato e flessibile conico in pvc color grigio acciaio.

Art. SSTX612D2P: Miscelatore per doccia con deviatore a 2 posizioni in acciaio INOX spazzolato.

Shower set composed by:
Art. SSA578CM20 SSA555LCM30: ultra slim shower head with arm all in brushed stainless steel.

Art. SSA546 SSA435 with SSA516150: minimal shower holder with water punch with minimal handshower completely in brushed stainless steel with shower flexible hose in pvc steel grey colour cm 150.

Art. SSTX612D2P: brushed stainless steel shower mixer, with 2 positions diverter.

SSTX615ZD2P7820

Disponibile con soffione da cm Ø20 cm e braccio a parete 30 cm.
Available with head shower cm Ø20 cm and wall arm 30 cm.

SSTX615ZD2P7825

Disponibile con soffione da cm Ø25 cm e braccio a parete da 30 cm.
Available with head shower cm Ø25 cm and wall arm 30 cm.

SSTX615ZD2P7830

Disponibile con soffione da cm Ø30 cm e braccio a parete da 30 cm.
Available with head shower cm Ø30 cm and wall arm 30 cm.

SSTX615SD2P7820

Disponibile con soffione da cm Ø20 cm e braccio a soffitto da 30 cm.
Available with head shower cm Ø20 cm and ceiling arm 30 cm.



Set doccia composto da:
 Art. SSA578 SSA555L: Soffione doccia ultra piatto e braccio tutto in acciaio INOX spazzolato.
 Art. SSA335 SSA435 con SSA516150: saliscendi minimale con doccetta tutto in acciaio INOX spazzolato e flessibile conico in pvc color grigio acciaio.
 Art. SSA520: presa acqua tipo rotondo in acciaio INOX spazzolato.
 Art. SSTX612D3P: Miscelatore per doccia con deviatore a 3 posizioni in acciaio INOX spazzolato.
 Art. SSSJETX: 6 getti anticalcare in acciaio INOX spazzolato.
Shower set composed by:
 Art. SSA578CM20 SSA555LCM30: *ultra slim shower head with arm all in brushed stainless steel.*
 Art. SSA335 SSA435 with SSA516150: *Minimal sliding bar with minimal handshower, completely in brushed stainless steel with shower flexible hose in pvc steel grey colour cm 150.*
 Art. SSA520: *wall connector, round in brushed stainless steel.*
 Art. SSTX612D3P: *brushed stainless steel shower mixer, with 3 positions diverter.*
 Art. SSSJETX: *6 antilimestone body jets in brushed stainless steel.*

SSTX613ZP7820

Disponibile con soffione da cm Ø20 cm e braccio a parete 30 cm.
Available with head shower cm Ø20 cm and wall arm 30 cm.

SSTX613ZP7825

Disponibile con soffione da cm Ø25 cm e braccio a parete da 30 cm.
Available with head shower cm Ø25 cm and wall arm 30 cm.

SSTX613ZP7830

Disponibile con soffione da cm Ø30 cm e braccio a parete da 30 cm.
Available with head shower cm Ø30 cm and wall arm 30 cm.

SSTX613SP7820

Disponibile con soffione da cm Ø20 cm e braccio a soffitto da 30 cm.
Available with head shower cm Ø20 cm and ceiling arm 30 cm.



Set doccia composto da:
 Art. SSA578 SSA555L: Soffione doccia ultra piatto e braccio tutto in acciaio INOX spazzolato.
 Art. SSA546 SSA435 con SSA516150: supporto lusso con presa acqua e doccetta tutto in acciaio INOX spazzolato e flessibile conico in pvc color grigio acciaio.
 Art. SSTX612D3P: Miscelatore per doccia con deviatore a 3 posizioni in acciaio INOX spazzolato.
 Art. SSSJETX: 6 getti anticalcare in acciaio INOX spazzolato.
Shower set composed by:
 Art. SSA578CM20 SSA555LCM30: *ultra slim shower head with arm all in brushed stainless steel.*
 Art. SSA546 SSA435 with SSA516150: *minimal shower holder with water punch with minimal handshower completely in brushed stainless steel with shower flexible hose in pvc steel grey colour cm 150.*
 Art. SSTX612D3P: *brushed stainless steel shower mixer, with 3 positions diverter.*
 Art. SSSJETX: *6 antilimestone body jets in brushed stainless steel.*

SSTX616ZP7820

Disponibile con soffione da cm Ø20 cm e braccio a parete 30 cm.
Available with head shower cm Ø20 cm and wall arm 30 cm.

SSTX616ZP7825

Disponibile con soffione da cm Ø25 cm e braccio a parete da 30 cm.
Available with head shower cm Ø25 cm and wall arm 30 cm.

SSTX616ZP7830

Disponibile con soffione da cm Ø30 cm e braccio a parete da 30 cm.
Available with head shower cm Ø30 cm and wall arm 30 cm.

SSTX616SP7820

Disponibile con soffione da cm Ø20 cm e braccio a soffitto da 30 cm.
Available with head shower cm Ø20 cm and ceiling arm 30 cm.

SSTX614ZPSSCA

Art. SSA566CA: Soffione doccia a parete in acciaio INOX spazzolato 2 funzioni: pioggia e cascata.
 Art. SSA335 SSA435 con SSA516150: Saliscendi minimale con doccetta tutto in acciaio INOX spazzolato e flessibile conico in pvc color grigio acciaio.
 Art. SSA520: presa acqua tipo rotondo in acciaio INOX spazzolato.
 Art. SSTX612D3P: Miscelatore per doccia con deviatore a 3 posizioni in acciaio INOX spazzolato.
Shower set composed by:
 Art. SSA566CA: *brushed stainless steel wall shower head, 2 functions: rain and waterfall.*
 Art. SSA335 SSA435 with SSA516150: *Minimal sliding bar with minimal handshower, completely in brushed stainless steel with shower flexible hose in pvc steel grey colour cm 150.*
 Art. SSA520: *wall connector, round in brushed stainless steel.*
 Art. SSTX612D3P: *brushed stainless steel shower mixer, with 3 positions diverter.*

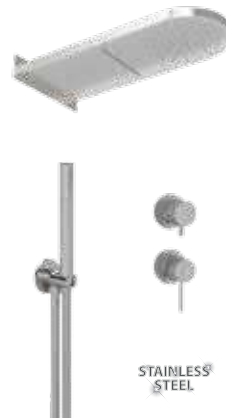

SSTX615ZPSSCA

Set doccia composto da:
 Art. SSA566CA: Soffione doccia a parete in acciaio INOX spazzolato 2 funzioni: pioggia e cascata.
 Art. SSA546 SSA435 con SSA516150: supporto lusso con presa acqua e doccetta tutto in acciaio INOX spazzolato e flessibile conico in pvc color grigio acciaio.
 Art. SSTX612D3P: Miscelatore per doccia con deviatore a 3 posizioni in acciaio INOX spazzolato.
Shower set composed by:
 Art. SSA566CA: *brushed stainless steel wall shower head, 2 functions: rain and waterfall.*
 Art. SSA546 SSA435 with SSA516150: *minimal shower holder with water punch with minimal handshower completely in brushed stainless steel with shower flexible hose in pvc steel grey colour cm 150.*
 Art. SSTX612D3P: *brushed stainless steel shower mixer, with 3 positions diverter.*

BOX
INCASSO
BUILT-IN
BOXWELLNESS
KITCROMOTERAPIA
COLOUR
THERAPIESOFFIONI
SHOWER
HEADPANNELLI
DOCCIA
SHOWER
PANELSCOLONNE
DOCCIA
SHOWER
COLUMNSALISCENDI
SLIDING
RAILSDOCCETTE
HAND
SHOWERSOASIS
SHUT-OFFBOCCHIE
SPOUTSACCESSORI
RUBINETTERIA
TAP
ACCESSORIES

Per richiedere la variante flessibile aggiungere la lettera al codice articolo.

To request a different flexible, add the letter to the article number.

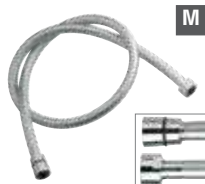
**A516150**

Flessibile doccia retinato realizzato in PVC atossico con attacco conico.
Flexible hose for shower with net working metal colour in atoxic PVC with one conical nut.

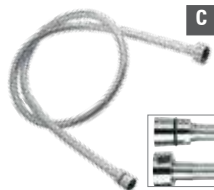
**A506150**

Flessibile doccia in PVC atossico con piattina cromata, attacco conico.
Flexible hose for shower in atoxic PVC and chrome flat wire, with one conical nut.



Set doccia Minimale composto da: soffione ultra slim con getti anticalcare con braccio doccia in ottone cromatoda 30 cm, presa acqua con supporto lusso in ottone cromato, doccetta in ABS cromato anticalcare ad 1 funzione con getti in silicone e flessibile 150 cm.

Minimal shower set composed of: ultra slim shower head with antilimestone jets and c.p. brass arm length 30 cm, c.p. water punch and shower holder in brass, c.p. ABS 1 function handshower antilimestone silicon jets and 150 cm flexible hose.

SET615ZD20

con soffione ultra piatto Ø 20 cm in acciaio INOX lucidato a specchio
with ultra slim stainless steel mirror polished shower head Ø 20 cm

SET615ZD25

con soffione ultra piatto Ø 25 cm in acciaio INOX lucidato a specchio.
with ultra slim stainless steel mirror polished shower head Ø 25 cm.



Set doccia quadrato composto da: soffione ultraslim con getti anticalcare e braccio doccia in ottone cromatoda 30 cm, presa acqua con supporto in ABS cromato, doccetta con getti in silicone, anticalcare e flessibile 150 cm.

Squared shower set composed of: ultra slim shower head with antilimestone jets and c.p. brass shower arm length 30 cm, c.p. water punch and shower holder in brass, 1 function c.p. ABS handshower with antilimestone silicon jets and 150 cm flexible hose.

SET615ZQ20Q

con soffione ultra piatto 20x20 cm in acciaio INOX lucidato a specchio.
with ultra slim stainless steel mirror polished shower head 20x20 cm.

SET615ZQ25Q

con soffione ultra piatto 25x25 cm in acciaio INOX lucidato a specchio.
with ultra slim stainless steel mirror polished shower head 25x25 cm.

**SET615Z8420**

€ 132,90

Set doccia Minimale composto da: braccio doccia rotondo in ottone cromato da 30 cm, soffione Ø 20 cm soffione lusso in ABS cromato con 50 getti in silicone autopulenti e anticalcare, presa acqua con supporto lusso in ottone cromato, doccetta in ABS cromato ad 1 funzione anticalcare con getti in silicone e flessibile 150 cm.

Minimal shower set composed of: round c.p. brass shower arm length 30 cm, c.p. deluxe ABS shower head Ø 20 cm with 50 silicon selfcleaning antilimestone jets, c.p. water punch/shower holder in brass, 1 function c.p. ABS handshower with anti-limestone silicon jets and 150 cm flexible hose.

**SET615Z88SQ**

Set doccia quadrato composto da: braccio doccia squadrato in ottone cromato da 30 cm, soffione pioggia a snodo in ABS cromo satinato con 104 getti in silicone anticalcare 23x23 cm, presa acqua con supporto in ottone cromato, doccetta ad 1 funzione in ABS cromato con getti in silicone, anticalcare e flessibile 150 cm.

Squared shower set composed of: squared c.p. brass shower arm length 30 cm, shower head with balljoint in ABS chrome-satin with 104 jets in silicon antilimestone 23x23 cm, c.p. water punch/shower holder in brass, 1 function c.p. ABS handshower with anti-limestone with silicon jets and 150 cm flexible hose.



Set doccia composto da: braccio doccia tondo in ottone cromato da 30 cm, soffione ultra slim quadrato con angoli arrotondati, presa acqua con supporto lusso presa acqua in ottone cromato, doccetta a 4 funzioni in ABS cromato con pulsante per il cambio getti, anticalcare con getti in silicone e flessibile 150 cm.

Shower set composed of: round c.p. brass shower arm length 30 cm, ultra slim squared with round corners shower head, c.p. water punch/shower holder in brass, 4 functions c.p. ABS handshower with button to change jets, anti-limestone with silicon jets and 150 cm flexible hose.

SET615Z7720Q

con soffione ultra piatto quadrato con angoli arrotondati 20x20 cm in acciaio INOX.
ultra slim squared rounded corners stainless steel shower head 20x20 cm

SET615Z7725Q

con soffione ultra piatto quadrato con angoli arrotondati 25x25 cm in acciaio INOX.
ultra slim squared rounded corners stainless steel shower head 25x25 cm

**SET615ZAD20Q**

Set doccia composto da: braccio doccia rotondo in ottone cromato da 30 cm, soffione in ABS cromato a pioggia squadrato con angoli arrotondati 20x20 cm con getti anticalcare, presa acqua con supporto lusso in ottone cromato, doccetta in ABS cromato a 4 funzioni e pulsante per il cambio getti, anticalcare con getti in silicone e flessibile 150 cm.

Shower set composed of: c.p. brass round shower arm length 30 cm, c.p. ABS squared with rounded corners shower head with rain jet 20x20 cm, with anti-limestone jets, c.p. water punch/shower holder in brass, c.p. handshower 4 functions with button to change jets, anti-limestone with silicon jets and 150 cm flexible hose.



BOX
INCASSO
BUILT-IN
BOX

WELLNESS
KIT

CROMOTERAPIA
COLOUR
THERAPIE

SOFFIONI
SHOWER
HEAD

PANNELLI
DOCCIA
SHOWER
PANELS

COLONNE
DOCCIA
SHOWER
COLUMN

SALISCENDI
SLIDING
RAILS

DOCCETTE
HAND
SHOWERS

OASIS
SHUT-OFF

BOCCHIE
SPOUTS

ACCESSORI
RUBINETTERIA
TAP
ACCESSORIES

VARIANTI FLESSIBILI - FLEXIBLE OPTIONS

Per richiedere la variante flessibile aggiungere la lettera al codice articolo.

To request a different flexible, add the letter to the article number.

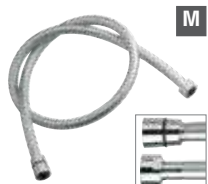

M

A516150

Flessibile doccia retinato realizzato in PVC atossico con attacco conico.
Flexible hose for shower with net working metal colour in atoxic PVC with one conical nut.



C

A506150

Flessibile doccia in PVC atossico con piattina cromata, attacco conico.
Flexible hose for shower in atoxic PVC and chrome flat wire, with one conical nut.



TA614Z

Set doccia composto da: soffione doccia quadrato con angoli arrotondati ultra piatto cm 20x20, in ABS cromato, con getti in silicone autopulenti e anticalcare e braccio in ottone cromato 30 cm, miscelatore doccia incasso con deviatore con piastra Tiara, saliscendi con asta ovale e doccetta cromata a 4 funzioni con pulsante per il cambio del getto, anticalcare in silicone, attacco presa acqua da 1/2 tipo rotondo pesante.

Shower set composed of: c.p. ABS ultra slim squared shower head with rounded edges cm 20x20, with silicon selfcleaning antilimestone jets and c.p. brass arm 30 cm, built-in shower mixer with diverter with Tiara Plate, sliding rail set with oval rod and c.p. handshower 4 functions with button to change the jets, anti-limestone with silicone jets, brass wall connector, round heavy type.



TA615Z

Set doccia composto da: soffione doccia ultrapiatto in ABS cromato, quadrato con angoli arrotondati cm 20x20, con getti in silicone autopulenti anticalcare e braccio in ottone cromato 30 cm, miscelatore doccia incasso con deviatore con piastra Tiara, doccia a 4 funzioni con pulsante per il cambio dei getti, anticalcare, supporto presa acqua lusso in ottone cromato e flessibile 150 cm.

Shower set composed of: c.p. ABS shower head, squared with rounded edges, ultrathin, 20x20 cm, with silicon selfcleaning antilimestone jets and c.p. brass arm 30 cm, built-in shower mixer with diverter with Tiara Plate, handshower 4 functions with button to change the jets anti-limestone with silicone jets, c.p. brass shower holder/water punch for built-in, with c.p. brass flexible hose 150 cm.



TA614ZB

Set doccia composto da: soffione doccia ultra piatto 33x22 cm in acciaio INOX lucidato a specchio con braccio cm 30, miscelatore vasca incasso con deviatore con piastra Tiara, saliscendi con asta ovale e doccetta cromata a 4 funzioni con pulsante per il cambio dell'intensità del getto, con getti anticalcare in silicone, attacco presa acqua da 1/2 tipo rotondo pesante.

Shower set composed of: ultra slim stainless steel mirror polished shower head 33x22 cm with arm cm 30, built-in bath/shower mixer with diverter with Tiara Plate, sliding rail set with oval rod and c.p. handshower 4 functions with button to change the intensity of the jet, anti-limestone with silicone jets, brass wall connector, round heavy type.



TA615ZB

Set doccia composto da: soffione doccia ultra piatto 33x22 cm in acciaio INOX lucidato a specchio con braccio in ottone cromato 30 cm, miscelatore doccia incasso con deviatore con piastra Tiara, doccia a 4 funzioni con pulsante per il cambio dell'intensità del getto, con getti anticalcare in silicone, supporto presa acqua lusso in ottone cromato e flessibile 150 cm.

Shower set composed of: ultra slim stainless steel mirror polished shower head 33x22 cm with c.p. brass arm 30 cm, built-in shower mixer with diverter with Tiara Plate, handshower 4 functions with button to change the intensity of the jet, anti-limestone with silicone jets, c.p. brass shower holder/water punch for built-in, with c.p. brass flexible hose 150 cm.

TA614ZO

Set doccia con:
 Art. A552CM30 A590 soffione doccia in ottone cromato 20x20 cm, con getti in silicone autopulenti e anticalcare e braccio in ottone cromato 30 cm;
 Art. TA612 miscelatore vasca incasso con deviatore con piastra Tiara;
 Art. A340 A495 A505 150 saliscendi in ottone cromato con asta minimale e doccetta minimale in ottone cromata ad 1 funzione e flessibile 150 cm in ottone cromato;
 Art. A525 attacco presa acqua da 1/2 tipo rotondo pesante.

Shower set with:
 Art. A552CM30 A590 chrome plated brass showerhead 20x20 cm, with silicon selfcleaning antilimestone jets and arm cm 30;
 Art. TA612 built-in bath/shower mixer with diverter with Tiara Plate;
 Art. A340 A495 A505 150 c.p. brass minimal sliding rail set with c.p. brass handshower 1 function, and 150 cm c.p. brass flexible hose;
 Art. A525 c.p. brass wall connector, round heavy type.



TA615ZO

Set doccia con:
 Art. A552CM30 A590 soffione doccia in ottone cromato 20x20 cm, con getti in silicone autopulenti e anticalcare e braccio in ottone cromato 30 cm;
 Art. TA612 miscelatore vasca incasso con deviatore con piastra Tiara;
 Art. A495 A546 A505 150 doccetta ad 1 funzione in ottone cromato con supporto presa acqua e flessibile 150 cm in ottone cromato.

Shower set with:
 Art. A552CM30 A590 chrome plated brass showerhead 20x20 cm, with silicon selfcleaning antilimestone jets and c.p. brass arm 30 cm;
 Art. TA612 built-in bath/shower mixer with diverter with Tiara Plate;
 Art. A495 A546 A505 150 c.p. brass handshower 1 function with c.p. brass shower holder/water punch for built-in, with 150 cm c.p. brass flexible hose.

SP614ZSS

Set doccia con soffione doccia a parete in acciaio INOX lucidato a specchio getto pioggia, saliscendi con doccetta ad 1 funzione in ottone cromato, flessibile conico in ottone cromato cm 150, presa acqua lusso quadrata, miscelatore vasca doccia incasso con deviatore.

Shower set with stainless steel mirror polished wall shower head with rain jet, deluxe sliding rail with c.p. brass hand shower 1 function, shower flexible hose in brass cm 150, luxury water punch, built-in bath/shower mixer with diverter.



SP615ZSS

Set doccia con soffione doccia a parete in acciaio INOX lucidato a specchio con getto pioggia, supporto doccia deluxe duplex con presa acqua, doccetta ad 1 funzione in ottone cromato e flessibile conico in ottone cromato 150 cm, miscelatore vasca doccia incasso con deviatore.

Shower set with stainless steel mirror polished wall shower head with rain jet, duplex deluxe shower holder with water punch in c.p. brass, with 1 function c.p. brass handshower, flexible hose in c.p. brass 150 cm, built-in bath/shower mixer with diverter.



Set doccia con soffione doccia a parete in acciaio INOX lucidato a specchio, saliscendi con doccetta ad 1 funzione tutto in ottone cromato, flessibile conico in ottone cromato cm 150, presa acqua lusso quadrata in ottone cromato, miscelatore monocomando per doccia.

Shower set with stainless steel mirror polished wall shower head, deluxe sliding rail with hand shower 1 function, all in c.p. brass, shower flexible hose in brass cm 150, luxury c.p. brass water punch, single lever built-in shower mixer.



Set doccia con soffione doccia a parete in acciaio INOX lucidato a specchio, supporto doccia presa acqua deluxe in ottone cromato, con doccetta ad 1 funzione in ottone cromato e flessibile conico in ottone cromato 150 cm, miscelatore monocomando per doccia.

Shower set with stainless steel mirror polished wall shower head, deluxe shower holder/water punch in c.p. brass, with c.p. brass hand shower 1 function with shower flexible hose in brass 150 cm, luxury water punch, single lever built-in shower mixer.



SK614ZSSCA

Disponibile con soffione a 2 getti, pioggia e cascata art. A562CA e miscelatore monocomando per doccia con deviatore a tre vie e 7 uscite su piastra unica SK612D7.

Available with 2 jets shower head, rain and waterfall and art. A562CA and single lever built-in shower mixer with three ways and 7 positions diverter on single flange SK612D7.

SK615ZSSCA

Disponibile con soffione a 2 getti, pioggia e cascata art. A562CA e miscelatore monocomando per doccia con deviatore a tre vie e 7 uscite su piastra unica SK612D7.

Available with 2 jets shower head, rain and waterfall and art. A562CA, single lever built-in shower mixer with three ways and 7 positions diverter on single flange SK612D7.

SK614ZSS

Disponibile con soffione A562 senza cascata, e miscelatore incasso con deviatore SK612.

Available with head shower A562 without waterfall jet and built-in mixer with diverter SK6102.

SK615ZSS

Disponibile con soffione A562 senza cascata, e miscelatore incasso con deviatore SK612.

Available with head shower A562 without waterfall jet and built-in mixer with diverter SK6102.



Set doccia con soffione a parete in acciaio INOX lucidato a specchio, saliscendi con doccetta ad 1 funzione tutto in ottone cromato, flessibile conico in ottone cromato 150 cm, presa acqua lusso quadrata, miscelatore monocomando per doccia, 6 getti anticalcare in ottone cromato.

Shower set with stainless steel mirror polished wall shower head, deluxe sliding rail with hand shower 1 function all in c.p. brass, shower flexible hose in brass cm 150, luxury water punch, single lever built-in shower mixer, 6 jets anti-limestone in c.p. brass.

SK613ZSSCA

Disponibile con soffione a 2 getti, pioggia e cascata art. A562CA e miscelatore monocomando per doccia con deviatore a 4 vie su piastra unica SK612D4.

Available with 2 jets shower head, rain and waterfall and art. A562CA and single lever built-in shower mixer with 4 ways diverter on single flange SK612D4.

SK613ZSS

Disponibile con soffione A562 senza cascata.

Available with head shower A562 without waterfall jet.



Set doccia con soffione a parete in acciaio INOX lucidato a specchio, supporto doccia presa acqua deluxe, con doccetta in ottone cromato ad 1 funzione e flessibile conico in ottone cromato 150 cm, miscelatore monocomando per doccia, 6 getti anticalcare in ottone cromato.

Shower set with stainless steel mirror polished wall shower head, shower holder/water punch deluxe in c.p. brass, with c.p. brass hand shower 1 function, shower flexible hose in brass 150 cm, luxury water punch, single lever built-in shower mixer, 6 jets anti-limestone in c.p. brass.

SK616ZSSCA

Disponibile con soffione a 2 getti, pioggia e cascata art. A562CA e miscelatore monocomando per doccia con deviatore a 4 vie su piastra unica SK612D4.

Available with 2 jets shower head, rain and waterfall and art. A562CA and single lever built-in shower mixer with 4 ways diverter on single flange SK612D4.

SK616ZSS

Disponibile con soffione A562 senza cascata.

Available with head shower A562 without waterfall jet.



Set doccia con soffione doccia ultra piatto in acciaio INOX lucidato a specchio, con braccio doccia in ottone cromato 30 cm, saliscendi e doccetta ad 1 funzione con flessibile 150 cm tutto in ottone cromati, presa acqua lusso quadrata, miscelatore incasso con deviatore a tre vie e sette posizioni su piastra unica, 6 getti anticalcare in ottone cromato.

Shower kit with ultra slim stainless steel mirror polished shower head with C.P. brass shower arm 30 cm, deluxe sliding rail with hand shower 1 function all in c.p. brass with flexible hose 150 cm, luxury water punch, built-in mixer with three ways diverter with seven positions on single flange and 6 jets anti-limestone in c.p. brass.

SK613Z7920

Disponibile con soffione da cm 20x20 cm e braccio da 30 cm.

Available with head shower cm 20x20 cm and arm 30 cm.

SK613Z7925

Disponibile con soffione da cm 25x25 cm e braccio da 30 cm.

Available with head shower cm 25x25 cm and arm 30 cm.

SK613Z7930

Disponibile con soffione da cm 30x30 cm e braccio da 30 cm.

Available with head shower cm 30x30 cm and arm 30 cm.

SK613Z7940

Disponibile con soffione da cm 40x40 cm e braccio da 40 cm.

Available with head shower cm 40x40 cm and arm 40 cm.

SK613S7920

Disponibile con soffione da cm 20x20 cm e braccio a soffitto da 30 cm.

Available with head shower cm 20x20 cm and ceiling arm 30 cm.



Set doccia con soffione doccia ultra piatto in acciaio INOX lucidato a specchio e braccio doccia in ottone cromato 30 cm, supporto doccia deluxe presa acqua deluxe, doccetta in ottone cromato ad 1 funzione e flessibile conico in ottone cromato 150 cm, miscelatore incasso con deviatore a tre vie e sette posizioni su piastra unica, 6 getti anticalcare in ottone cromato.

Shower kit with ultra slim stainless steel mirror polished shower head with C.P. brass shower arm 30 cm, c.p. brass deluxe shower holder/water punch, c.p. brass hand shower 1 function with shower flexible hose in brass 150 cm, built-in mixer with three ways seven positions with diverter on single flange and 6 jets anti-limestone in c.p. brass.

SK616Z7920

Disponibile con soffione da cm 20x20 cm e braccio da 30 cm.

Available with head shower cm 20x20 cm and arm 30 cm.

SK616Z7925

Disponibile con soffione da cm 25x25 cm e braccio da 30 cm.

Available with head shower cm 25x25 cm and arm 30 cm.

SK616Z7930

Disponibile con soffione da cm 30x30 cm e braccio da 30 cm.

Available with head shower cm 30x30 cm and arm 30 cm.

SK616Z7940

Disponibile con soffione da cm 40x40 cm e braccio da 40 cm.

Available with head shower cm 40x40 cm and arm 40 cm.

SK616S7920

Disponibile con soffione da cm 20x20 cm e braccio a soffitto da 30 cm.

Available with head shower cm 20x20 cm and ceiling arm 30 cm.

BOX
INCASSO
BUILT-IN
BOX

WELLNESS
KIT

CROMOTERAPIA

COLOUR
THERAPIE

SOFFIONI

SHOWER
HEAD

PANNELLI
DOCCIA

SHOWER
PANELS

COLONNE
DOCCIA

SHOWER
COLUMN

SALISCENDI

SLIDING RAILS

DOCCETTE

HAND
SHOWERS

OASIS

SHUT-OFF

BOCCHE

SPOUTS

ACCESSORI
RUBINETTERIA

TAP
ACCESSORIES

WELLNESS KIT



Set doccia con soffione doccia ultra piatto in acciaio INOX lucidato a specchio, con braccio doccia in ottone cromato 30 cm, saliscendi e doccetta ad 1 funzione tutto in ottone cromato e flessibile 150 cm, presa acqua lusso quadrata, miscelatore incasso con deviatore.

Shower kit with ultra slim stainless steel mirror polished shower head with C.P. brass shower arm 30 cm, deluxe sliding rail with hand shower 1 function all in c.p. brass and flexible hose 150 cm, luxury water punch and built-in mixer with diverter.

SK614Z7920

Disponibile con soffione da cm 20x20 cm e braccio da 30 cm.
Available with head shower cm 20x20 cm and arm 30 cm.

SK614Z7925

Disponibile con soffione da cm 25x25 cm e braccio da 30 cm.
Available with head shower cm 25x25 cm and arm 30 cm.

SK614Z7930

Disponibile con soffione da cm 30x30 cm e braccio da 30 cm.
Available with head shower cm 30x30 cm and arm 30 cm.

SK614Z7940

Disponibile con soffione da cm 40x40 cm e braccio da 40 cm.
Available with head shower cm 40x40 cm and arm 40 cm.

SK614S7920

Disponibile con soffione da cm 20x20 cm e braccio a soffitto da 30 cm.
Available with head shower cm 20x20 cm and ceiling arm 30 cm.



Set doccia con soffione doccia ultra piatto in acciaio INOX lucidato a specchio, con braccio doccia in ottone cromato 30 cm, supporto doccia/presa acqua deluxe, doccetta ad 1 funzione e flessibile conico tutto in ottone cromato 150 cm, miscelatore incasso con deviatore.

Shower kit with ultra slim stainless steel mirror polished shower head with C.P. brass shower arm 30 cm, deluxe shower holder/water punch with hand shower 1 function all in c.p. brass and shower flexible hose in brass 150 cm, built-in mixer with diverter.

SK615Z7920

Disponibile con soffione da cm 20x20 cm e braccio da 30 cm.
Available with head shower cm 20x20 cm and arm 30 cm.

SK615Z7925

Disponibile con soffione da cm 25x25 cm e braccio da 30 cm.
Available with head shower cm 25x25 cm and arm 30 cm.

SK615Z7930

Disponibile con soffione da cm 30x30 cm e braccio da 30 cm.
Available with head shower cm 30x30 cm and arm 30 cm.

SK615Z7940

Disponibile con soffione da cm 40x40 cm e braccio da 40 cm.
Available with head shower cm 40x40 cm and arm 40 cm.

SK615S7920

Disponibile con soffione da cm 20x20 cm e braccio a soffitto da 30 cm.
Available with head shower cm 20x20 cm and ceiling arm 30 cm.



SK616Z

Set doccia con soffione a pioggia rettangolare 24x14 cm con getti in silicone anticalcare e braccio 30 cm, doccetta ad 1 funzione con supporto/presa acqua snodato lusso quadrato, miscelatore e deviatore 3 vie e 7 posizioni, 6 getti anticalcare. Tutto in ottone cromato.

Shower kit with rectangular shower head 24x14 cm with rain jet antilimestone and arm 30 cm, hand shower 1 function with shower holder/water punch connector squared, shower mixer with 3 ways diverter and 7 positions, 6 jets antilimestone. All in c.p. brass



SK617Z

Set doccia con soffione a pioggia rettangolare 24x14 cm con getti in silicone anticalcare e braccio 30 cm, doccetta ad 1 funzione con supporto/presa acqua snodato lusso quadrato, miscelatore e deviatore 3 vie e 7 posizioni, bocca incasso per miscelatore vasca-doccia. Tutto in ottone cromato.

Shower kit with rectangular shower head 24x14 cm with rain jet with antilimestone and arm 30 cm, hand shower 1 function with shower holder/water punch connector squared, shower mixer with 3 ways diverter and 7 positions, built-in spout. All in c.p. brass.



SK615Z

Set doccia con soffione a pioggia rettangolare 24x14 cm con getti in silicone anticalcare e braccio 30 cm, doccetta ad 1 funzione con supporto/presa acqua snodato lusso quadrato, miscelatore incasso con deviatore. Tutto in ottone cromato.

Shower kit with rectangular shower head 24x14 cm with rain jet antilimestone and arm 30 cm, hand shower 1 function with shower holder/water punch connector squared, Built-in bath/shower mixer with diverter. All in c.p. brass.



SK614ZC

Set doccia con soffione doccia a cascata, saliscendi lusso con doccetta ad 1 funzione, attacco presa acqua tipo quadrato pesante, miscelatore incasso con deviatore. Tutto in ottone cromato.

Shower kit with c.p. brass shower head with waterfall jet, deluxe sliding rail with hand shower 1 function, wall water punch connector, squared and heavy type, built-in bath/shower mixer with diverter. All in c.p. brass.

**SK613Z**

Set doccia con soffione a pioggia rettangolare 24x14 cm con getti anticalcare e braccio 30 cm, saliscendi lusso con doccetta ad 1 funzione, attacco presa acqua tipo quadrato pesante, miscelatore e deviatore 3 vie e 7 posizioni e 6 getti anticalcare. Tutto in ottone cromato.

Shower kit with rectangular shower head 24x14 cm with rain jet with antilimestone and arm 30 cm, deluxe sliding rail with hand shower 1 function, wall water punch connector, squared and heavy type, shower mixer with 3 ways diverter and 7 positions and 6 jets anti limestone. All in c.p. brass.

**SK614Z**

Set doccia con soffione a pioggia rettangolare 24x14 cm con getti anticalcare e braccio 30 cm, saliscendi lusso con doccetta ad 1 funzione, attacco presa acqua tipo quadrato pesante, miscelatore incasso con deviatore. Tutto in ottone cromato.

Shower kit with rectangular shower head 24x14 cm with rain jet with antilimestone and arm 30 cm, deluxe sliding rail with hand shower 1 function, wall water punch connector, squared and heavy type, built-in bath/shower mixer with diverter. All in c.p. brass.

BOX
INCASSO
BUILT-IN
BOXWELLNESS
KIT**OX23613Z**

Set doccia con soffione a pioggia quadrato 20x20 cm con getti anticalcare e braccio 30 cm, saliscendi lusso con doccetta ad 1 funzione, attacco presa acqua tipo quadrato pesante, miscelatore con deviatore 3 vie e 7 posizioni e 6 getti anticalcare. Tutto in ottone cromato.

Shower set with squared shower head 20x20 cm rain jet with antilimestone and arm 30 cm, deluxe sliding rail with hand shower 1 function, water punch connector squared and heavy type, shower mixer with 3 ways diverter and 7 positions and 6 jets anti limestone. All in c.p. brass.

**OX23616Z**

Set doccia con soffione a pioggia quadrato 20x20 cm con getti anticalcare e braccio 30 cm, doccetta ad 1 funzione con supporto/presa acqua snodato lusso quadrato, deviatore a 3 vie e 7 posizioni, 6 getti anticalcare. Tutto in ottone cromato.

Shower set with squared shower head 20x20 cm rain jet with antilimestone and arm 30 cm, hand shower 1 function with shower holder/water punch connector squared, with shower mixer 3 ways diverter and 7 positions, 6 jets anti limestone. All in c.p. brass.

**OX23615Z**

Set doccia con soffione a pioggia quadrato 20x20 cm con getti anticalcare e braccio 30 cm, doccetta ad 1 funzione con supporto/presa acqua snodato lusso quadrato, miscelatore incasso con deviatore. Tutto in ottone cromato.

Shower set with squared shower head 20x20 cm rain jet with antilimestone and arm 30 cm, hand shower 1 function with shower holder/water punch connector squared, Built-in bath/shower mixer with diverter. All in c.p. brass.

**OX23617Z**

Set doccia con soffione a pioggia quadrato 20x20 cm con getti anticalcare e braccio 30 cm, doccetta ad 1 funzione con supporto/presa acqua snodato lusso quadrato, miscelatore con deviatore 3 vie e 7 posizioni e bocca da parete. Tutto in ottone cromato.

Shower set with squared shower head 20x20 cm rain jet with antilimestone and arm 30 cm, hand shower 1 function with shower holder/water punch connector squared, shower mixer with 3 ways diverter and 7 positions, built-in spout. All in c.p. brass.

CROMOTERAPIA
COLOUR
THERAPIESOFFIONI
SHOWER
HEADPANNELLI
DOCCIA
SHOWER
PANELSCOLONNE
DOCCIA
SHOWER
COLUMNSALISCENDI
SLIDING
RAILSDOCCETTE
HAND
SHOWERSOASIS
SHUT-OFFBOCCH
SPOUTSACCESSORI
RUBINETTERIA
TAP
ACCESSORIES

WELLNESS KIT



OX23614Z

Set doccia con soffione a pioggia quadrato 20x20 cm con getti anticalcare e braccio 30 cm, saliscendi lusso con doccetta ad 1 funzione, attacco presa acqua tipo quadrato pesante, miscelatore incasso con deviatore. Tutto in ottone cromato.
Shower set with squared shower head 20x20 cm rain jet with antilimestone and arm 30 cm, deluxe sliding rail with hand shower 1 function, water punch connector squared and heavy type, built-in bath/shower mixer with diverter. All in c.p. brass.



OX23619Z

Set doccia con colonna doccia con presa acqua incorporata con soffione a pioggia quadrato 20x20 cm con getti anticalcare e doccetta ad 1 funzione, miscelatore incasso con deviatore, bocca incasso. Tutto in ottone cromato.
Shower set with shower column with integrated water punch, squared shower head 20x20 cm rain jet with antilimestone, 1 function hand shower, built-in bath/shower mixer with diverter, built-in shower spout. All in c.p. brass.



W4442

Set doccia con soffione a pioggia rettangolare 24x14 cm con getti in silicone anticalcare e braccio 30 cm, saliscendi lusso ultra piatto con asta rettangolare con doccetta ultrapiatta, attacco presa acqua, tipo quadrato, pesante, batteria doccia incasso con deviatore. Tutto in ottone cromato.
Shower kit with rectangular shower head 24x14 cm with rain jet antilimestone and arm 30 cm, deluxe sliding rail extra flat rectangular rod with hand shower extra flat, wall water punch connector, squared and heavy type, built-in bathtub with diverter. All in c.p. brass.



W4442CA

Set doccia con soffione a cascata, saliscendi lusso ultra piatto con asta rettangolare con doccetta ultrapiatta, attacco presa acqua tipo quadrato pesante, batteria doccia incasso con deviatore. Tutto in ottone cromato.
Shower kit with shower head with waterfall jet, deluxe sliding rail extra flat rectangular rod with hand shower extra flat, wall water punch connector squared and heavy type, built-in bathtub with diverter. All in c.p. brass.



W4441

Set doccia con soffione a pioggia rettangolare 24x14 cm con getti in silicone anticalcare e braccio 30 cm, doccetta quadrata ad 1 funzione, supporto snodato lusso presa acqua quadrato per incasso, batteria doccia incasso con deviatore. Tutto in ottone cromato.
Shower kit with rectangular shower head 24x14 cm with rain jet antilimestone and arm 30 cm, 1 function square handshower, adjustable shower holder/water punch squared, built-in shower with diverter. All in c.p. brass.



W4441CA

Set doccia con soffione a cascata, doccetta quadrata ad 1 funzione, supporto snodato lusso presa acqua quadrato per incasso, batteria doccia incasso con deviatore. Tutto in ottone cromato.
Shower kit with shower head with waterfall jet, 1 function square handshower, adjustable shower holder/water punch squared, built-in shower with diverter. All in c.p. brass.



BOX
INCASSO
BUILT-IN
BOX

WELLNESS
KIT

CROMOTERAPIA
COLOUR
THERAPIE

SOFFIONI
SHOWER
HEAD

VARIANTI FLESSIBILI - FLEXIBLE OPTIONS

Per richiedere la variante flessibile aggiungere la lettera al codice articolo.

To request a different flexible, add the letter to the article number.



M

A516150

Flessibile doccia retinato realizzato in PVC atossico con attacco conico.
Flexible hose for shower with net working metal colour in atoxic PVC with one conical nut.



C

A506150

Flessibile doccia in PVC atossico con piastrina cromata, attacco conico.
Flexible hose for shower in atoxic PVC and chrome flat wire, with one conical nut.



PANNELLI
DOCCIA
SHOWER
PANELS

COLONNE
DOCCIA
SHOWER
COLUMN

FU61420

Set doccia composto da:
Art. A552CM30 A594: soffione doccia Ø20 cm con getti anticalcare e braccio minimale 30 cm tutto in ottone cromato.
Art. FU612: Monocomando vasca/doccia incasso con deviatore.
Art. A340 A435 A505 150: saliscendi con asta minimale, doccetta ad 1 funzione con flessibile conico 150 cm, tutto in ottone cromato.
Art. A525: presa acqua rotonda in ottone cromato.

Shower set composed of:
Art. A552CM30 A594: chrome plated brass showerhead Ø20 cm, silicon selfcleaning antilimestone jets, with minimal arm in brass cm 30.
Art. FU612: Built-in bath/shower mixer with diverter.
Art. A340 A435 A505 150: sliding rail set with 1 function handshower, conical shower flexiblehose 150 cm, all in c.p. brass.
Art. A525: luxury water punch round type in c.p. brass.



FU61520

Set doccia composto da:
Art. A552CM30 A594: soffione doccia Ø20 cm con getti anticalcare e braccio minimale 30 cm, tutto in ottone cromato.
Art. FU612: Monocomando vasca/doccia incasso con deviatore.
Art. A546 A435 A505 150: doccetta ad 1 funzione, presa acqua/supporto e flessibile conico 150 cm, tutto in ottone cromato.

Shower set composed of:
Art. A552CM30 A594: showerhead Ø20 cm with silicon selfcleaning antilimestone jets, and minimal arm 30 cm, all in c.p. brass.
Art. FU612: Built-in bath/shower mixer with diverter.
Art. A546 A435 A505 150: 1 function handshower, water punch/shower holder with shower flexible hose 150 cm, all in c.p. brass.



SALISCENDI
SLIDING RAILS

DOCCETTE
HAND
SHOWERS

OASIS
SHUT-OFF

BOCCHE
SPOUTS

ACCESSORI
RUBINETTERIA
TAP
ACCESSORIES

WELLNESS KIT

FU614Z

Set doccia composto da:
 Art. A552CM30 A584AD20: soffione doccia cm 20x20 quadrato con angoli arrotondati ultrapiatto in ABS cromato, e getti anticalcare con braccio minimale in ottone cromato 30 cm.

Art. FU612: Monocomando vasca/doccia incasso con deviatore.

Art. A388 A477 A505X150: saliscendi cromato con asta minimale ovale dritta, doccetta cromata a 4 funzioni anticalcare con pulsante per cambio getti, flessibile conico in ottone cromato 150 cm.

Art. A525: presa acqua rotonda in ottone cromato.

Shower set composed of:

Art. A552CM30 A584AD20: Chrome plated ABS squared ultraflat showerhead with rounded edges, silicon selfcleaning antilimestone jets, with minimal arm in brass 30 cm.

Art. FU612: Built-in bath/shower mixer with diverter.

Art. A388 A477 A505X150: sliding rail set with c.p. ABS antilimestone handshower 4 functions with button to change the jets, conical shower flexible hose in c.p. brass 150 cm.

Art. A525: luxury water punch round type.



FU615Z

Set doccia composto da:
 Art. A552CM30 A584AD20: soffione doccia cm 20x20 quadrato con angoli arrotondati ultrapiatto in ABS cromato, e getti anticalcare con braccio minimale in ottone cromato 30 cm.

Art. FU612: Monocomando vasca/doccia incasso con deviatore.

Art. A546 A477 A505X150: doccetta in ABS cromato anticalcare a 4 funzioni con pulsante per cambio getti, presa acqua supporto in ottone cromato con flessibile conico in ottone cromato 150 cm.

Art. A552CM30 A584AD20: Chrome plated ABS squared ultraflat showerhead with rounded edges, silicon selfcleaning antilimestone jets, with minimal arm in brass 30 cm.

Art. FU612: Built-in bath/shower mixer with diverter.

Art. A546 A477 A505X150: c.p. ABS antilimestone handshower 4 functions with button to change the jets, water punch/shower holder in brass and flexible hose in brass 150 cm.



TK6152O

Set doccia composto da:
 Art. A594 A552CM30: Soffione doccia Ø20 cm con getti anticalcare e braccio 30 cm tutto in ottone cromato.

Art. A546 A435 con A505 150: doccetta ad 1 funzione con supporto presa acqua e flessibile conico 150 cm, tutto in ottone cromato.

Art. TK612: Miscelatore incasso con deviatore e piastra lusso.

Shower set composed by:

Art. A594 A552CM30: shower head Ø20 cm with antilimestone silicon jets, and arm 30 cm, all in c.p. brass.

Art. A546 A435 with A505 150: water punch/shower holder with 1 function handshower and shower flexible hose 150 cm, all in c.p. brass.

Art. TK612: Built-in mixer with diverter and deluxe flange.



TK6142O

Set doccia composto da:
 Art. A594 A552CM30: Soffione doccia Ø20 cm con getti anticalcare e braccio 30 cm tutto in ottone cromato.

Art. A340 A435 con A505 150: saliscendi minimale con doccetta minimale e flessibile conico 150 cm, tutto in ottone cromato.

Art. A525: presa acqua tipo rotondo pesante in ottone cromato.

Art. TK612: Miscelatore incasso con deviatore e piastra lusso.

Shower set composed by:

Art. A594 A552CM30: shower head Ø20 cm with antilimestone silicon jets, and arm 30 cm, all in c.p. brass.

Art. A340 A435 with A505 150: minimal sliding rail with minimal handshower and shower flexible hose 150 cm, all in c.p. brass.

Art. A525: C.p. brass wall connector, round heavy type

Art. TK612: Built-in mixer with diverter and deluxe flange.



TK614Z

Set doccia composto da:
 Art. A578CM20 A552CM30: soffione doccia ultra piatto Ø20 cm in acciaio INOX lucidato a specchio con getti anticalcare e braccio in ottone cromato 30 cm.

Art. A335 A435 con A505 150: saliscendi minimale con doccetta ad 1 funzione e flessibile conico 150 cm, tutto in ottone cromato.

Art. A525: presa acqua tipo rotondo pesante in ottone cromato.

Art. TK612: miscelatore incasso con deviatore e piastra lusso.

Shower set composed by:

Art. A578CM20 A552CM30: ultra slim stainless steel mirror polished shower head Ø20 cm with antilimestone silicon jets, and arm in c.p. brass 30 cm.

Art. A335 A435 with A505 150: Minimal sliding bar with 1 function handshower, and shower flexible hose 150 cm, all in c.p. brass.

Art. A525: C.p. brass wall connector, round heavy type

Art. TK612: Built-in mixer with diverter and deluxe flange.



TK615Z

Set doccia composto da:
 Art. A578CM20 A552CM30: soffione doccia ultra piatto Ø20 cm in acciaio INOX lucidato a specchio con getti anticalcare e braccio in ottone cromato 30 cm.

Art. A546 A435 con A505 150: doccetta ad 1 funzione con supporto presa acqua e flessibile conico 150 cm, tutto in ottone cromato.

Art. TK612: Miscelatore incasso con deviatore e piastra lusso.

Shower set composed by:

Art. A578CM20 A552CM30: ultra slim stainless steel mirror polished shower head Ø20 cm with antilimestone silicon jets, and arm in c.p. brass 30 cm.

Art. A546 A435 with A505 150: water punch/shower holder with 1 function handshower and shower flexible hose 150 cm, all in c.p. brass.

Art. TK612: Built-in mixer with diverter and deluxe flange.



TK625Z

Set doccia composto da:

Art. A578CM20 A552CM30: soffione doccia ultra piatto Ø20 cm in acciaio INOX lucidato a specchio con getti anticalcare e braccio in ottone cromato 30 cm.

Art. TK625: miscelatore e deviatore su piastre separate.

Art. A546 A435 con A505 150: doccietta ad 1 funzione con supporto presa acqua e flessibile conico 150 cm, tutto in ottone cromato.

Shower set composed by:

Art. A578CM20 A552CM30: ultra slim stainless steel mirror polished shower head Ø20 cm with antilimestone silicon jets, and arm in c.p. brass 30 cm.

Art. TK625: built-in shower mixer with diverter on double flange.

Art. A546 A435 with A505 150: water punch/shower holder with 1 function handshower and shower flexible hose 150 cm, all in c.p. brass.

**DV4440**

Batteria incasso vasca con deviatore, doccietta Diva ad 1 funzione, supporto presa acqua e flessibile conico 150 cm, bocca a parete Diva, tutto in ottone cromato. *Built-in bathtub mixer with diverter, water punch/shower holder, Diva 1 function handshower and shower flexible hose 150 cm, built-in spout; all in c.p. brass.*



BOX
INCASSO
BUILT-IN
BOX

WELLNESS
KIT

DV4441

Batteria incasso doccia con deviatore, doccietta Diva ad 1 funzione, supporto presa acqua e flessibile conico 150 cm, braccio 30 cm e soffione Ø 35 cm; tutto in ottone cromato.

Built-in shower mixer with diverter, water punch/shower holder, Diva 1 function handshower and shower flexible hose 150 cm, showerhead Ø 35 cm and arm 30 cm; all in c.p. brass.

**DV614ZC**

Set doccia con soffione doccia a cascata, miscelatore vasca incasso con deviatore Diva, saliscendi con doccetta Diva ad 1 funzione e flessibile 150 cm, attacco presa acqua da 1/2 tipo rotondo pesante; tutto in ottone cromato.

Shower set with waterfall shower head, built in bath mixer with diverter, Diva sliding rail with 1 function Diva handshower and 150 cm flexible hose, water punch connector round heavy type; all in c.p. brass



CROMOTERAPIA
COLOUR
THERAPIE

SOFFIONI
SHOWER
HEAD

PANNELLI
DOCCIA
SHOWER
PANELS

COLONNE
DOCCIA
SHOWER
COLUMN

SALISCENDI
SLIDING
RAILS

DOCCETTE
HAND
SHOWERS

OASIS
SHUT-OFF

BOCCHE
SPOUTS

ACCESSORI
RUBINETTERIA
TAP
ACCESSORIES

DV4442CA

Batteria incasso doccia con deviatore, soffione doccia a cascata, saliscendi con doccetta Diva ad 1 funzione e flessibile 150 cm, attacco presa acqua da 1/2 tipo rotondo pesante; tutto in ottone cromato.

Built-in shower mixer with diverter, waterfall shower head, built in bath mixer with diverter, Diva sliding rail with 1 function Diva handshower and 150 cm flexible hose, water punch connector round heavy type; all in c.p. brass

**DV4441CA**

Batteria incasso doccia con deviatore, soffione doccia a cascata, doccietta Diva ad 1 funzione, supporto presa acqua e flessibile conico 150 cm; tutto in ottone cromato.

Built-in shower mixer with diverter, waterfall shower head, built in bath mixer with diverter, water punch/shower holder, Diva 1 function handshower and shower flexible hose 150 cm; all in c.p. brass.



WELLNESS KIT



Set doccia con soffione doccia ultra piatto in acciaio INOX lucidato a specchio con getti anticalcare in silicone. braccio in ottone cromato 30 cm, saliscendi minimale con doccetta ad 1 funzione, flessibile conico; tutto in ottone cromato, presa acqua tipo rotondo pesante, miscelatore incasso con deviatore e piastra lusso.

Shower kit with ultra slim stainless steel mirror polished shower head with silicon antilimestone jets, c.p. brass arm 30 cm, sliding bar with minimal 1 function handshower, flexible hose 150 cm; all in c.p. brass, wall connector round heavy type in c.p. brass, and built-in mixer with diverter and deluxe flange.

S20614Z7820

Disponibile con soffione da cm Ø20 cm e braccio da 30 cm.
Available with head shower cm Ø20 cm and arm 30 cm.

S20614Z7825

Disponibile con soffione da cm Ø25 cm e braccio da 30 cm.
Available with head shower cm Ø25 cm and arm 30 cm.

S20614Z7830

Disponibile con soffione da cm Ø30 cm e braccio da 30 cm.
Available with head shower cm Ø30 cm and arm 30 cm.

S20614Z7840

Disponibile con soffione da cm Ø40 cm e braccio da 40 cm.
Available with head shower cm Ø40 cm and arm 40 cm.



Set doccia con soffione doccia ultra piatto in acciaio INOX lucidato a specchio con getti anticalcare in silicone. braccio in ottone cromato 30 cm, doccetta ad 1 funzione con supporto presa acqua e flessibile conico 150 cm, tutto in ottone cromato, miscelatore incasso con deviatore e piastra lusso.

Shower kit with ultra slim stainless steel mirror polished shower head, with c.p. brass arm, water punch/shower holder with 1 function handshower and shower flexible hose 150 cm, all in c.p. brass, built-in mixer with diverter and deluxe flange.

S20615Z7820

Disponibile con soffione da cm Ø20 cm e braccio da 30 cm.
Available with head shower cm Ø20 cm and arm 30 cm.

S20615Z7825

Disponibile con soffione da cm Ø25 cm e braccio da 30 cm.
Available with head shower cm Ø25 cm and arm 30 cm.

S20615Z7830

Disponibile con soffione da cm Ø30 cm e braccio da 30 cm.
Available with head shower cm Ø30 cm and arm 30 cm.

S20615Z7840

Disponibile con soffione da cm Ø40 cm e braccio da 40 cm.
Available with head shower cm Ø40 cm and arm 40 cm.



Set doccia con soffione doccia ultra piatto in acciaio INOX lucidato a specchio con getti anticalcare in silicone. braccio in ottone cromato 30 cm, saliscendi minimale con doccetta ad 1 funzione, flessibile conico; tutto in ottone cromato, presa acqua tipo rotondo pesante, miscelatore monocomando per doccia a 3 vie e 7 posizioni su piastra unica, 6 getti anticalcare in ottone cromato.

Shower kit with ultra slim stainless steel mirror polished shower head with silicon antilimestone jets, c.p. brass arm 30 cm, sliding bar with minimal 1 function handshower, flexible hose 150 cm; all in c.p. brass, wall connector round heavy type in c.p. brass, and single lever built-in shower mixer with 3 ways and 7 positions on single flange, 6 jets anti-limestone in c.p. brass.

S20613Z7820

Disponibile con soffione da cm Ø20 cm e braccio da 30 cm.
Available with head shower cm Ø20 cm and arm 30 cm.

S20613Z7825

Disponibile con soffione da cm Ø25 cm e braccio da 30 cm.
Available with head shower cm Ø25 cm and arm 30 cm.

S20613Z7830

Disponibile con soffione da cm Ø30 cm e braccio da 30 cm.
Available with head shower cm Ø30 cm and arm 30 cm.

S20613Z7840

Disponibile con soffione da cm Ø40 cm e braccio da 40 cm.
Available with head shower cm Ø40 cm and arm 40 cm.



Set doccia con soffione doccia ultra piatto in acciaio INOX lucidato a specchio con getti anticalcare in silicone. braccio in ottone cromato 30 cm, doccetta ad 1 funzione con supporto presa acqua e flessibile conico 150 cm, tutto in ottone cromato, miscelatore monocomando per doccia a 3 vie e 7 posizioni su piastra unica, 6 getti anticalcare in ottone cromato.

Shower kit with ultra slim stainless steel mirror polished shower head, with c.p. brass arm, water punch/shower holder with 1 function handshower and shower flexible hose 150 cm, all in c.p. brass, and single lever built-in shower mixer with 3 ways and 7 positions on single flange, 6 jets anti-limestone in c.p. brass.

S20616Z7820

Disponibile con soffione da cm Ø20 cm e braccio da 30 cm.
Available with head shower cm Ø20 cm and arm 30 cm.

S20616Z7825

Disponibile con soffione da cm Ø25 cm e braccio da 30 cm.
Available with head shower cm Ø25 cm and arm 30 cm.

S20616Z7830

Disponibile con soffione da cm Ø30 cm e braccio da 30 cm.
Available with head shower cm Ø30 cm and arm 30 cm.

S20616Z7840

Disponibile con soffione da cm Ø40 cm e braccio da 40 cm.
Available with head shower cm Ø40 cm and arm 40 cm.



Set doccia con soffione doccia ultrapiatto 50x25 cm, a parete in acciaio INOX lucidato a specchio, saliscendi minimale con doccetta ad 1 funzione completamente in ottone cromato e flessibile conico in ottone cromato, presa acqua tipo rotondo pesante e miscelatore monocomando per doccia con deviatore a tre vie e sette posizioni su unica piastra.

Shower set with ultra slim stainless steel mirror polished wall shower head 50x25 cm, sliding bar with 1 function handshower, completely in c.p. brass and with shower flexible hose in brass cm 150, brass wall connector, round heavy type, single lever built-in shower mixer with three ways diverter with seven position on single flange.

S20614ZSSCA

Disponibile con soffione doccia ultrapiatto 50x25 cm, a parete in acciaio INOX lucidato a specchio, 2 getti, pioggia e cascata.

Available with ultra slim stainless steel mirror polished wall shower head, 2 jets rain and waterfall.

S20614ZSS

Disponibile con soffione doccia ultrapiatto 50x25 cm, a parete in acciaio INOX lucidato a specchio, getto a pioggia.

Available with ultra slim stainless steel mirror polished wall shower head, rain jet.



Set doccia con soffione doccia ultrapiatto 50x25 cm, a parete in acciaio INOX lucidato a specchio, doccetta ad 1 funzione con supporto presa acqua e flessibile conico 150 cm tutto in ottone cromato, miscelatore monocomando per doccia con deviatore a tre vie e sette posizioni su unica piastra.

Shower set with ultra slim stainless steel mirror polished wall shower head, 50x25 cm, water punch/shower holder with 1 function handshower and shower flexible hose 150 cm, all in c.p. brass, single lever built-in shower mixer with three ways diverter with seven position on single flange.

S20615ZSSCA

Disponibile con soffione doccia ultrapiatto 50x25 cm, a parete in acciaio INOX lucidato a specchio, 2 getti, pioggia e cascata.

Available with ultra slim stainless steel mirror polished wall shower head, 2 jets rain and waterfall.

S20615ZSS

Disponibile con soffione doccia ultrapiatto 50x25 cm, a parete in acciaio INOX lucidato a specchio, getto a pioggia.

Available with ultra slim stainless steel mirror polished wall shower head, rain jet.



S20615ZC

Set doccia con soffione a cascata, miscelatore vasca incasso con deviatore, doccetta ad 1 funzione con supporto presa acqua e flessibile conico 150 cm. Tutto in ottone cromato.

Shower set with shower head with waterfall jet, built-in bath mixer with diverter, water punch/shower holder with 1 function handshower and shower flexible hose 150 cm. All in c.p. brass.



S20613ZSSCA

Disponibile con soffione doccia ultrapiatto 50x25 cm, a parete in acciaio INOX lucidato a specchio, 2 getti, pioggia e cascata.

Available with ultra slim stainless steel mirror polished wall shower head, 2 jets rain and waterfall.

S20613ZSS

Disponibile con soffione doccia ultrapiatto 50x25 cm, a parete in acciaio INOX lucidato a specchio, getto a pioggia.

Available with ultra slim stainless steel mirror polished wall shower head, rain jet.



S20616ZSSCA

Disponibile con soffione doccia ultrapiatto 50x25 cm, a parete in acciaio INOX lucidato a specchio, 2 getti, pioggia e cascata.

Available with ultra slim stainless steel mirror polished wall shower head, 2 jets rain and waterfall.

S20616ZSS

Disponibile con soffione doccia ultrapiatto 50x25 cm, a parete in acciaio INOX lucidato a specchio, getto a pioggia.

Available with ultra slim stainless steel mirror polished wall shower head, rain jet.



S20616ZC

Set doccia con soffione a cascata, doccetta ad 1 funzione con supporto presa acqua e flessibile conico 150 cm. Tutto in ottone cromato. 6 getti minimali anticalcare e miscelatore e deviatore 3 vie e 7 posizioni. Tutto in ottone cromato.

Shower set with shower head with waterfall jet, water punch/shower holder with 1 function handshower and shower flexible hose 150 cm, 6 minimal jets antilimestone and shower mixer and 3 ways diverter and 7 positions. All in c.p. brass.

BOX
INCASSO
BUILT-IN
BOX

WELLNESS
KIT

CROMOTERAPIA
COLOUR
THERAPIE

SOFFIONI
SHOWER
HEAD

PANNELLI
DOCCIA
SHOWER
PANELS

COLONNE
DOCCIA
SHOWER
COLUMN

SALISCENDI
SLIDING
RAILS

DOCCETTE
HAND
SHOWERS

OASIS
SHUT-OFF

BOCCHIE
SPOUTS

ACCESSORI
RUBINETTERIA
TAP
ACCESSORIES

WELLNESS KIT



S20613Z

Set doccia con soffione anticalcare Ø20 cm anticalcare con braccio 30 cm, saliscendi con doccetta ad 1 funzione, attacco presa acqua da 1/2 tipo rotondo pesante, miscelatore e deviatore 3 vie e 7 posizioni e 6 getti anticalcare. Tutto in ottone cromato.

Shower set with antilimestone shower head Ø20 cm with arm 30 cm, sliding rail with hand shower 1 function, water punch connector, squared and heavy type, shower mixer and 3 ways diverter and 7 positions and 6 jets anti limestone. All in c.p. brass.



S20616Z

Set doccia con soffione anticalcare Ø20 cm con braccio in ottone 30 cm, doccetta in ottone cromato ad 1 funzione con supporto doccia presa acqua lusso e flessibile 150 cm, 6 getti anticalcare e miscelatore e deviatore 3 vie e 7 posizioni. Tutto in ottone cromato.

Shower set with antilimestone shower head Ø20 cm with arm 30 cm, 1 function hand shower with shower holde/water punch and flexible hose 150 cm, 6 minimal jets antilimestone and shower mixer and 3 ways diverter and 7 positions. All in c.p. brass.



S20614Z

Set doccia con soffione anticalcare Ø20 cm con braccio 30 cm, miscelatore vasca/doccia incasso con deviatore, saliscendi con doccetta ad 1 funzione, attacco presa acqua da 1/2 tipo rotondo pesante. Tutto in ottone cromato.

Shower set with antilimestone shower head Ø20 cm with arm 30 cm, built-in bath mixer with diverter, sliding rail with 1 function hand shower, wall water punch connector round heavy type. All in c.p. brass.



S20615Z

Set doccia con soffione anticalcare con braccio cm 30, miscelatore vasca incasso con deviatore, doccetta in ottone cromato ad 1 funzione con supporto doccia presa acqua lusso e flessibile 150 cm. Tutto in ottone cromato.

Shower set with shower head with arm cm 30, built-in bath mixer with diverter, 1 function hand shower with shower holde/water punch and flexible hose 150 cm. All in c.p. brass.



S20617Z

Set doccia con soffione anticalcare Ø20 cm con braccio 30 cm, miscelatore e deviatore 3 vie e 7 posizioni, doccetta ad 1 funzione e supporto presa acqua lusso con flessibile 150 cm, bocca incasso. Tutto in ottone cromato.

Shower set with antilimestone shower head Ø20 cm with arm 30 cm, 1 function hand shower with shower holder/water punch and flexible hose 150 cm, shower mixer 3 ways diverter and 7 positions, built-in spout. All in c.p. brass.



S20619Z

Set doccia composto da colonna doccia con presa acqua, doccetta ad 1 funzione e soffione anticalcare Ø 20 cm, miscelatore vasca/doccia incasso con deviatore, bocca incasso. Tutto in ottone cromato.

Shower set composed of shower column with water punch, 1 function handshower, antilimestone shower head Ø20 cm, built-in bath mixer with diverter, built-in spout. All in c.p. brass.



OM614Z

Set doccia composto da soffione anticalcare minimale in ABS lusso Ø 20 cm con braccio in ottone cromato 30 cm, miscelatore vasca/doccia incasso con deviatore su piastra Omega, saliscendi minimale con doccetta in ABS cromato anticalcare a 1 funzione, attacco presa acqua da 1/2 tipo rotondo pesante.

Shower set composed of minimal deluxe antilimestone ABS shower head Ø 20 cm with c.p. brass arm 30 cm, built-in bath/shower mixer with diverter with Omega Plate, Minimal sliding rail set with 1 function c.p. ABS anti-limestone handshower, brass wall connector, round heavy type.



OM615Z

Set doccia composto da soffione minimale anticalcare in ABS lusso Ø 20 cm con braccio in ottone cromato 30 cm, miscelatore vasca/doccia incasso con deviatore su piastra Omega, doccetta anticalcare in ABS cromato ad 1 funzione con supporto doccia presa acqua lusso e flessibile 150 cm.

Shower set composed of minimal deluxe ABS shower head Ø 20 cm with arm cm 30, built-in bath/shower mixer with diverter with Omega Plate, 1 function antilimestone c.p. ABS hand shower with shower holde/water punch and flexible hose 150 cm.

**OM614ZO**

Set doccia composto da soffione anticalcare Ø 20 cm con braccio 30 cm, miscelatore vasca/doccia incasso con deviatore su piastra Omega, saliscendi minimale con doccetta ad 1 funzione, attacco presa acqua da 1/2 tipo rotondo pesante. Tutto in ottone cromato

Shower set composed of antilimestone shower head Ø 20 cm with arm 30 cm, built-in bath/shower mixer with diverter with Omega Plate, Minimal sliding rail set with 1 function handshower, brass wall connector, round heavy type. All in c.p. brass.

OM615ZO

Set doccia composto da soffione anticalcare Ø 20 cm con braccio 30 cm, miscelatore vasca incasso con deviatore su piastra Omega, doccetta ad 1 funzione con supporto presa acqua. Tutto in ottone cromato.

Shower set composed of shower head Ø 20 cm with arm 30 cm, built-in bath/shower mixer with diverter on Omega Plate, 1 function handshower with shower holder/water punch. All in c.p. brass.



BOX
INCASSO
BUILT-IN
BOX

WELLNESS
KIT

**SR614Z**

Set doccia composto da soffione minimale in ABS lusso Ø20 cm con braccio 30 cm, miscelatore incasso vasca/doccia con deviatore, saliscendi minimale in ABS cromato con doccetta in ABS cromato anticalcare a 4 funzioni, attacco presa acqua da 1/2 tipo rotondo pesante.

Shower set composed of minimal deluxe ABS shower head Ø20 cm with arm cm 30, built-in bath/shower mixer with diverter, c.p. ABS minimal sliding rail set with anti-limestone 4 functions hand shower, brass wall connector, round heavy type.

**SR615Z**

Set doccia composto da soffione minimale in ABS lusso Ø20 cm con braccio 30 cm, miscelatore incasso vasca/doccia con deviatore, con doccetta anticalcare a 4 funzioni con supporto presa acqua.

Shower set composed of minimal deluxe ABS shower head Ø20 cm with arm cm 30, built-in bath/shower mixer with diverter, anti-limestone c.p. ABS 4 functions handshower with waterpunch-shower holder.

CROMOTERAPIA
COLOUR
THERAPIE

SOFFIONI
SHOWER
HEAD

PANNELLI
DOCCIA
SHOWER
PANELS

COLONNE
DOCCIA
SHOWER
COLUMN

SALISCENDI
SLIDING
RAILS

DOCCETTE
HAND
SHOWERS

OASIS
SHUT-OFF

BOCCHIE
SPOUTS

ACCESSORI
RUBINETTERIA
TAP
ACCESSORIES

**SR614ZO**

Set doccia composto da soffione minimale in ottone cromato Ø20 cm con braccio 30 cm, miscelatore incasso vasca/doccia con deviatore, saliscendi minimale con doccetta a 1 funzione, attacco presa acqua da 1/2 tipo rotondo pesante. Tutto in in ottone cromato.

Shower set composed of minimal deluxe c.p. brass shower head Ø20 cm with arm 30 cm, built-in bath/shower mixer with diverter, Minimal sliding rail set with handshower, wall connector round heavy type. All in c.p. brass.

**SR615ZO**

Set doccia composto da soffione minimale in ottone cromato Ø20 cm con braccio 30 cm, miscelatore incasso vasca/doccia con deviatore, doccetta ad 1 funzione e supporto presa acqua. Tutto in ottone cromato.

Shower set minimal deluxe cp. brass shower head Ø20 cm with arm 30 cm, built-in bath/shower mixer with diverter, 1 function handshower with waterpunch/shower holder. All in c.p. brass.



VARIANTI FLESSIBILI - FLEXIBLE OPTIONS

Per richiedere la variante flessibile aggiungere la lettera al codice articolo.

To request a different flexible, add the letter to the article number.

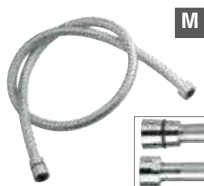

M

A516150

Flessibile doccia retinato realizzato in PVC atossico con attacco conico.
Flexible hose for shower with net working metal colour in atoxic PVC with one conical nut.



C

A506150

Flessibile doccia in PVC atossico con piastrina cromata, attacco conico.
Flexible hose for shower in atoxic PVC and chrome flat wire, with one conical nut.



Set doccia termostatico con soffione anticalcare a pioggia rettangolare 24x14 cm con braccio 30 cm, saliscendi lusso con doccetta ad 1 funzione, attacco presa acqua tipo quadrato pesante, miscelatore incasso termostatico con deviatore. Tutto in ottone cromato.

Thermostatic shower set with antilimestone rectangular 24x14 cm shower head rain jet with arm cm 30, deluxe sliding rail with hand shower 1 function, wall water punch connector, squared and heavy type, thermostatic built-in bath/shower mixer with diverter. All in c.p. brass.

SKT614Z

con braccio a parete.
with wall mounted arm.

**SKT614S**

con braccio a soffitto.
with ceiling arm.



Set doccia termostatico con soffione doccia anticalcare a parete in acciaio INOX lucidato a specchio saliscendi lusso con doccetta ad 1 funzione e flessibile 150 cm tutto in ottone cromato, attacco presa acqua tipo quadrato pesante, miscelatore incasso termostatico con deviatore.

Thermostatic shower set with antilimestone stainless steel mirror polished wall shower head, deluxe sliding rail with 1 function hand shower and flexible hose 150 cm all in c.p. brass, wall water punch connector, squared and heavy type, thermostatic built-in bath/shower mixer.

SKT614ZSSCA

con soffione A562CA a 2 getti, pioggia e cascata, e miscelatore incasso con deviatore a 3 vie e 7 posizioni su piastra unica SKT612D7.



with A562CA shower head with 2 jets rain and waterfall and built-in mixer with 3 ways diverter and 7 positions on single flange SKT612D7.

SKT614ZSS

con soffione A562 senza cascata, e miscelatore incasso con deviatore SKT612.



with A562 shower head with rain jet, without waterfall and built-in mixer with diverter SKT612.

**SKT615Z**

con braccio a parete.
with wall mounted arm.

**SKT615ZSSCA**

con soffione A562CA a 2 getti, pioggia e cascata, e miscelatore incasso con deviatore a 3 vie e 7 posizioni su piastra unica SKT612D7.



with A562CA shower head with 2 jets rain and waterfall and built-in mixer with 3 ways diverter and 7 positions on single flange SKT612D7.

SKT615S

con braccio a soffitto.
with ceiling.

**SKT615ZSS**

con soffione A562 senza cascata, e miscelatore incasso con deviatore SKT612.



with A562 shower head with rain jet, without waterfall and built-in mixer with diverter SKT612.

**SKT620Z**

con braccio a parete.
with wall mounted arm.

**SKT620ZSSCA**

con soffione A562CA a 2 getti, pioggia e cascata, e miscelatore incasso con deviatore a 3 vie e 7 posizioni su piastra unica SKT612D7.



with A562CA shower head, 2 jets rain and waterfall and built-in mixer with 3 ways diverter and 7 positions on single flange SKT612D7.

SKT620S

con braccio a soffitto.
with ceiling.

**SKT620ZSS**

con soffione A562 senza cascata, e miscelatore incasso con deviatore SKT612.



with A562 shower head with rainjet, without waterfall and built-in mixer with diverter SKT612.

SKT617Z

Set doccia termostatico con soffione anticalcare a pioggia rettangolare 24x14 cm con braccio 30 cm, doccetta ad 1 funzione con supporto/presa acqua snodato lusso quadrato, miscelatore termostatico e deviatore 3 vie e 7 posizioni, bocca incasso per miscelatore vasca-doccia. Tutto in ottone cromato.

Thermostatic shower set with antilimestone rectangular shower head with rain jet 24x14 cm with arm 30 cm, hand shower 1 function with shower holder/water punch connector squared, thermostatic shower mixer and 3 ways diverter and 7 positions, built-in spout. All in c.p. brass.

BOX
INCASSO
BUILT-IN
BOXWELLNESS
KITCROMOTERAPIA
COLOUR
THERAPIESOFFIONI
SHOWER
HEADPANNELLI
DOCCIA
SHOWER
PANELSCOLONNE
DOCCIA
SHOWER
COLUMNSALISCENDI
SLIDING RAILSDOCCETTE
HAND
SHOWERSOASIS
SHUT-OFFBOCCHIE
SPOUTSACCESSORI
RUBINETTERIA
TAP
ACCESSORIES



SKT613Z

Set doccia termostatico con soffione a pioggia anticalcare rettangolare 24x14 cm con braccio 30 cm, saliscendi lusso con doccetta ad 1 funzione, attacco presa acqua tipo quadrato pesante, miscelatore termostatico e deviatore 3 vie e 7 posizioni e 6 getti anticalcare. Tutto in ottone cromato.
Thermostatic shower set with antilimestone rectangular shower head with rain jet 24x14 cm, arm 30 cm, deluxe sliding rail with hand shower 1 function, water punch connector squared and heavy type, thermostatic shower mixer 3 ways diverter and 7 positions, 6 jets anti limestone. All in c.p. brass.



SKT616Z

Set doccia termostatico con soffione anticalcare a pioggia rettangolare 24x14 cm con braccio 30 cm, doccetta ad 1 funzione con supporto/presa acqua snodato lusso quadrato, miscelatore termostatico con deviatore 3 vie e 7 posizioni, 6 getti anticalcare. Tutto in ottone cromato.
Thermostatic shower set with antilimestone rectangular shower head rain jet 24x14 cm with arm 30 cm, hand shower 1 function with shower holder/water punch connector squared, thermostatic shower mixer 3 ways diverter and 7 positions, 6 jets anti limestone. All in c.p. brass.



SKT618Z

Set doccia termostatico con colonna doccia a barra quadrata, deluxe, con deviatore, presa acqua e centralina supporto doccetta, soffione doccia quadrato 20x20 cm con getti in silicone anticalcare, doccetta ad 1 funzione e flessibile conico 150 cm, presa acqua/attacco a muro quadrato, miscelatore incasso termostatico doccia. Tutto in ottone cromato.
Thermostatic shower set with squared bar deluxe shower column with diverter and wall connection, sliding part, squared shower head in brass with antilimestone silicone jets 20x20 cm, 1 function handshower with conical nut flexible hose 150 cm, and thermostatic built-in single-lever shower mixer. All in c.p. brass.



SKT614ZC

Set doccia termostatico con soffione doccia getto a cascata, saliscendi lusso con doccetta ad 1 funzione, attacco presa acqua tipo quadrato pesante, miscelatore incasso termostatico con deviatore. Tutto in ottone cromato.
Thermostatic shower set with waterfall shower head, deluxe sliding rail with hand shower 1 function, wall water punch connector squared and heavy type, thermostatic built-in bath/shower mixer with diverter. All in c.p. brass.



OXT23613Z

Set doccia con soffione anticalcare a pioggia quadrato 20x20 cm con braccio 30 cm, saliscendi lusso con doccetta ad 1 funzione, attacco presa acqua tipo quadrato pesante, miscelatore termostatico con deviatore a 3 vie e 7 posizioni e 6 getti anticalcare. Tutto in ottone cromato.
Shower set with antilimestone squared shower head 20x20 cm rain jet with arm 30 cm, deluxe sliding rail with hand shower 1 function, wall water punch connector, squared and heavy type, thermostatic shower mixer with 3 ways diverter and 7 positions and 6 jets anti limestone. All in c.p. brass.



OXT23616Z

Set doccia con soffione quadrato anticalcare a pioggia 20x20 cm con braccio 30 cm, doccetta ad 1 funzione con supporto/presa acqua snodato lusso quadrato, miscelatore termostatico con deviatore a 3 vie e 7 posizioni e 6 getti anticalcare. Tutto in ottone cromato.
Shower set with antilimestone squared shower head rain jet 20x20 cm with arm 30 cm, hand shower 1 function with shower holder/water punch connector squared, thermostatic shower mixer 3 ways diverter and 7 positions, 6 jets anti limestone. All in c.p. brass.



**OXT23614Z**

Set doccia con soffione anticalcare a pioggia quadrato 20x20 cm con braccio 30 cm, saliscendi lusso con doccetta ad 1 funzione, attacco presa acqua tipo quadrato pesante, miscelatore incasso termostatico con deviatore. Tutto in ottone cromato.

Shower set with squared shower head rain jet 20x20 cm with arm 30 cm, deluxe sliding rail with hand shower 1 function, wall water punch connector squared and heavy type, with thermostatic built-in bath/shower mixer with diverter. All in c.p. brass.

**OXT23615Z**

Set doccia con soffione a pioggia quadrato 20x20 cm con braccio 30 cm, doccetta ad 1 funzione con supporto/presa acqua snodato lusso quadrato, miscelatore incasso termostatico con deviatore. Tutto in ottone cromato.

Shower set with squared shower head rain jet 20x20 cm with arm 30 cm, hand shower 1 function with shower holder/water punch connector squared, thermostatic built-in bath/shower mixer with diverter. All in c.p. brass.

BOX
INCASSO
BUILT-IN
BOXWELLNESS
KITCROMOTERAPIA
COLOUR
THERAPIESOFFIONI
SHOWER
HEADPANNELLI
DOCCIA
SHOWER
PANELSCOLONNE
DOCCIA
SHOWER
COLUMNSALISCENDI
SLIDING RAILSDOCCETTE
HAND
SHOWERSOASIS
SHUT-OFFBOCCHE
SPOUTSACCESSORI
RUBINETTERIA
TAP
ACCESSORIES**OXT23617Z**

Set doccia con soffione a pioggia quadrato 20x20 cm con braccio 30 cm, doccetta ad 1 funzione con supporto/presa acqua snodato lusso quadrato, con miscelatore termostatico con deviatore a 3 vie e 7 posizioni e bocca. Tutto in ottone cromato.

Shower set with squared shower head rain jet 20x20 cm with arm 30 cm, hand shower 1 function with shower holder/water punch connector squared, thermostatic shower mixer 3 ways diverter and 7 positions, built-in spout. All in c.p. brass.

**OXT23619Z**

Set doccia con colonna doccia con deviatore, presa acqua e centralina supporto doccetta, soffione anticalcare e getto pioggia quadrato 20x20 cm, doccetta ad 1 funzione, miscelatore incasso termostatico con deviatore, bocca incasso. Tutto in ottone cromato.

Shower set composed of shower column with diverter, wall connection and sliding part, antilimestone squared shower head with rain jet 20x20 cm, 1 function hand shower, thermostatic built-in bath/shower mixer with diverter, built-in spout. All in c.p. brass.





VARIANTI FLESSIBILI - FLEXIBLE OPTIONS

Per richiedere la variante flessibile aggiungere la lettera al codice articolo.

To request a different flexible, add the letter to the article number.

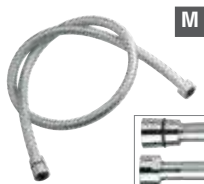

M

A516150

Flessibile doccia retinato realizzato in PVC atossico con attacco conico.
Flexible hose for shower with net working metal colour in atoxic PVC with one conical nut.



C

A506150

Flessibile doccia in PVC atossico con piattina cromata, attacco conico.
Flexible hose for shower in atoxic PVC and chrome flat wire, with one conical nut.

**ST20614Z**

con braccio a parete.
with wall mounted arm.



Set doccia con soffione minimale anticalcare Ø20 cm con braccio 30 cm, miscelatore termostatico vasca/doccia incasso con deviatore, saliscendi minimale con doccetta ad 1 funzione e flessibile conico 150 cm, attacco presa acqua da 1/2 tipo rotondo pesante. Tutto in ottone cromato.

Shower set with antilimestone minimal shower head Ø20 cm with arm 30 cm, thermostatic built-in bath mixer with diverter, sliding rail minimal with 1 function handshower and conical flexible hose 150 cm, wall water punch connector round heavy type. All in c.p. brass.

**ST20614ZSSCA**

Set doccia con soffione doccia anticalcare ultrapiatto a parete in acciaio INOX lucidato a specchio, miscelatore termostatico con deviatore, saliscendi minimale con doccetta ad 1 funzione e flessibile conico 150 cm, attacco presa acqua da 1/2 tipo rotondo pesante. Tutto in ottone cromato.

Shower set with antilimestone ultra slim stainless steel mirror polished wall shower head, thermostatic shower mixer with diverter, sliding rail with 1 function handshower and conical flexible hose 150 cm, wall water punch connector round heavy type. All in c.p. brass.

con soffione A564CA a 2 getti, pioggia e cascata, e miscelatore incasso con deviatore a 3 vie e 7 posizioni su flangia unica ST20612D7.

with A564CA shower head with 2 jets rain and waterfall and built-in mixer with 3 ways diverter with 7 positions on single flange ST20612D7.

ST20614S

con braccio a soffitto.
with ceiling.

**ST20614ZSS**

con soffione A564 getto pioggia senza cascata, e miscelatore incasso con deviatore ST20612.

with A564 shower head with rain jet without waterfall and built-in mixer with diverter ST20612.



Set doccia con soffione anticalcare Ø20 cm e braccio 30 cm, miscelatore termostatico con deviatore 2 vie, doccetta ad 1 funzione con supporto lusso e flessibile conico 150 cm, bocca incasso con deviatore. Tutto in ottone cromato.

Shower set composed of shower head Ø20 cm with arm 30 cm, 1 function handshower with shower holder and conical flexible hose 150 cm, thermostatic shower mixer 2 ways diverter and built-in spout with diverter. All in c.p. brass.

ST20620Z

con braccio a parete.
with wall mounted arm.



Set doccia con soffione doccia ultrapiatto a parete in acciaio INOX lucidato a specchio, miscelatore termostatico con deviatore, doccetta e supporto lusso per incasso, bocca incasso con deviatore. Tutto in ottone cromato.

Shower set with ultra slim stainless steel mirror polished wall shower head, 1 function handshower with shower holder, thermostatic shower mixer with diverter and built-in spout with diverter. All in c.p. brass.

ST20620ZSSCA

con soffione A564CA a 2 getti, pioggia e cascata, e miscelatore incasso con deviatore a 3 vie e 7 posizioni su piastra unica ST20612D7.

with A564CA shower head with 2 jets rain and waterfall and built-in mixer with 3 ways diverter with 7 positions on single flange ST20612D7.



ST20620S

con braccio a soffitto.
with ceiling.



ST20620ZSS

con soffione A564 getto pioggia senza cascata, e miscelatore incasso con deviatore ST20612.

with A564 shower head with rain jet without waterfall and built-in mixer with diverter ST20612.



Set doccia con soffione anticalcare Ø20 cm e braccio 30 cm, miscelatore termostatico con deviatore 2 vie, doccetta ad 1 funzione con supporto presa acqua lusso. Tutto in ottone cromato.

Shower set composed of shower head Ø20 cm with arm 30 cm, thermostatic shower mixer 2 ways diverter, hand shower with shower holder/water punch. All in c.p. brass.

ST20615Z

con braccio a parete.
with wall mounted arm.



Set doccia con soffione doccia anticalcare ultrapiatto a parete in acciaio INOX lucidato a specchio, miscelatore termostatico con deviatore 2 vie, doccetta ad 1 funzione con supporto presa acqua lusso. Tutto in ottone cromato.

Shower set with antilimestone ultra slim stainless steel mirror polished wall shower head, thermostatic shower mixer 2 ways diverter, hand shower with shower holder/water punch. All in c.p. brass.

ST20615ZSSCA

con soffione A564CA a 2 getti, pioggia e cascata, e miscelatore incasso con deviatore a 3 vie e 7 posizioni su piastra unica ST20612D7.

with A564CA shower head with 2 jets rain and waterfall and built-in mixer with 3 ways diverter with 7 positions on single flange ST20612D7.



ST20615S

con braccio a soffitto.
with ceiling.



ST20615ZSS

con soffione A564 getto pioggia senza cascata, e miscelatore incasso con deviatore ST20612.

with A564 shower head with rain jet without waterfall and built-in mixer with diverter ST20612.

BOX
INCASSO
BUILT-IN
BOXWELLNESS
KIT

CROMOTERAPIA

COLOUR
THERAPIESOFFIONI
SHOWER
HEADPANNELLI
DOCCIA
SHOWER
PANELSCOLONNE
DOCCIA
SHOWER
COLUMNSALISCENDI
SLIDING RAILSDOCCETTE
HAND
SHOWERSOASIS
SHUT-OFFBOCCHIE
SPOUTSACCESSORI
RUBINETTERIA
TAP
ACCESSORIES

WELLNESS KIT



ST20617Z

Set doccia composto da soffione anticalcare Ø 20 cm con braccio 30 cm, miscelatore termostatico e deviatore 3 vie e 7 posizioni, doccetta ad 1 funzione con supporto presa acqua lusso per incasso, bocca incasso. Tutto in ottone cromato.

Shower set composed of antilimescale shower head Ø20 cm with arm 30 cm, hand shower with shower holder/water punch, thermostatic shower mixer 3 ways diverter and 7 positions and built-in spout. All in c.p. brass.



ST20615ZC

Set doccia composto da soffione a cascata, miscelatore vasca incasso termostatico con deviatore, doccetta ad 1 funzione con supporto presa acqua lusso per incasso. Tutto in ottone cromato.

Shower set composed of waterfall shower head, thermostatic built-in bath mixer with diverter, 1 function hand shower with shower holder/water punch. All in c.p. brass.



**ST20613Z**

Set doccia composto da soffione minimale anticalcare Ø20 cm con braccio 30 cm, saliscendi minimale con doccetta ad 1 funzione, attacco presa acqua 1/2 tipo rotondo pesante, miscelatore termostatico e deviatore 3 vie e 7 posizioni e 6 getti anticalcare. Tutto in ottone cromato.

Shower set composed of antilimestone minimal shower head Ø20 cm with arm 30 cm, minimal sliding rail with hand shower 1 function, wall water punch connector, squared and heavy type, thermostatic shower mixer and 3 ways diverter and 3 ways diverter and 7 positions and 6 jets anti limestone. All in c.p. brass.

**ST20616Z**

Set doccia composto da soffione minimale anticalcare Ø 20 cm con braccio in ottone 30 cm, doccia con supporto presa acqua lusso per incasso, 6 getti anticalcare e miscelatore termostatico con deviatore 3 vie e 7 posizioni. Tutto in ottone cromato.

Shower set composed of antilimestone shower head Ø20 cm with arm 30 cm, 1 function hand shower with shower holder/water punch, 6 jets antilimestone, thermostatic shower mixer 3 ways diverter and 7 positions. All in c.p. brass.

**ST20616ZC**

Set doccia composto da soffione a cascata, doccetta ad 1 funzione con supporto presa acqua lusso per incasso, 6 getti anticalcare e miscelatore con deviatore termostatico 3 vie e 7 posizioni. Tutto in ottone cromato.

Shower set composed of waterfall shower head, 1 function hand shower with shower holder/water punch, 6 jets antilimestone and thermostatic shower mixer 3 ways diverter and 7 positions. All in c.p. brass.

**ST20619Z**

Set doccia composto da colonna doccia con deviatore, presa acqua e centralina supporto doccetta, soffione anticalcare Ø20 cm, doccetta ad 1 funzione, miscelatore vasca/doccia incasso termostatico con deviatore, bocca incasso. Tutto in ottone cromato.

Shower set composed of shower column with diverter and wall connection, sliding part, antilimestone shower head Ø20 cm, 1 function handshower, thermostatic built-in bath mixer with diverter, built-in spout. All in c.p. brass.

BOX
INCASSO
BUILT-IN
BOXWELLNESS
KITCROMOTERAPIA
COLOUR
THERAPIESOFFIONI
SHOWER
HEADPANNELLI
DOCCIA
SHOWER
PANELSCOLONNE
DOCCIA
SHOWER
COLUMNSALISCENDI
SLIDING
RAILSDOCCETTE
HAND
SHOWERSOASIS
SHUT-OFFBOCCE
SPOUTSACCESSORI
RUBINETTERIA
TAP
ACCESSORIES

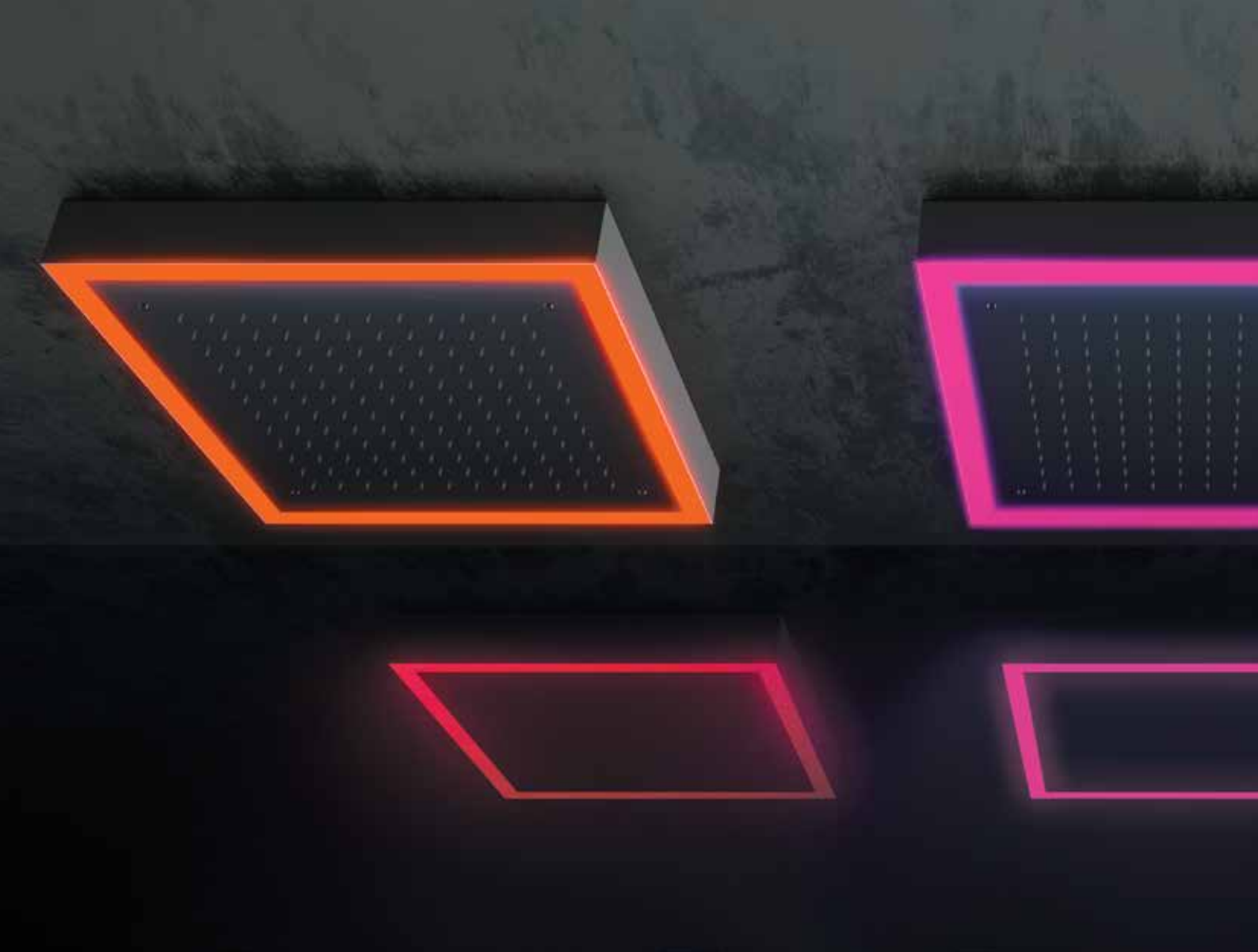

CROMOTERAPIA COLOUR THERAPIE

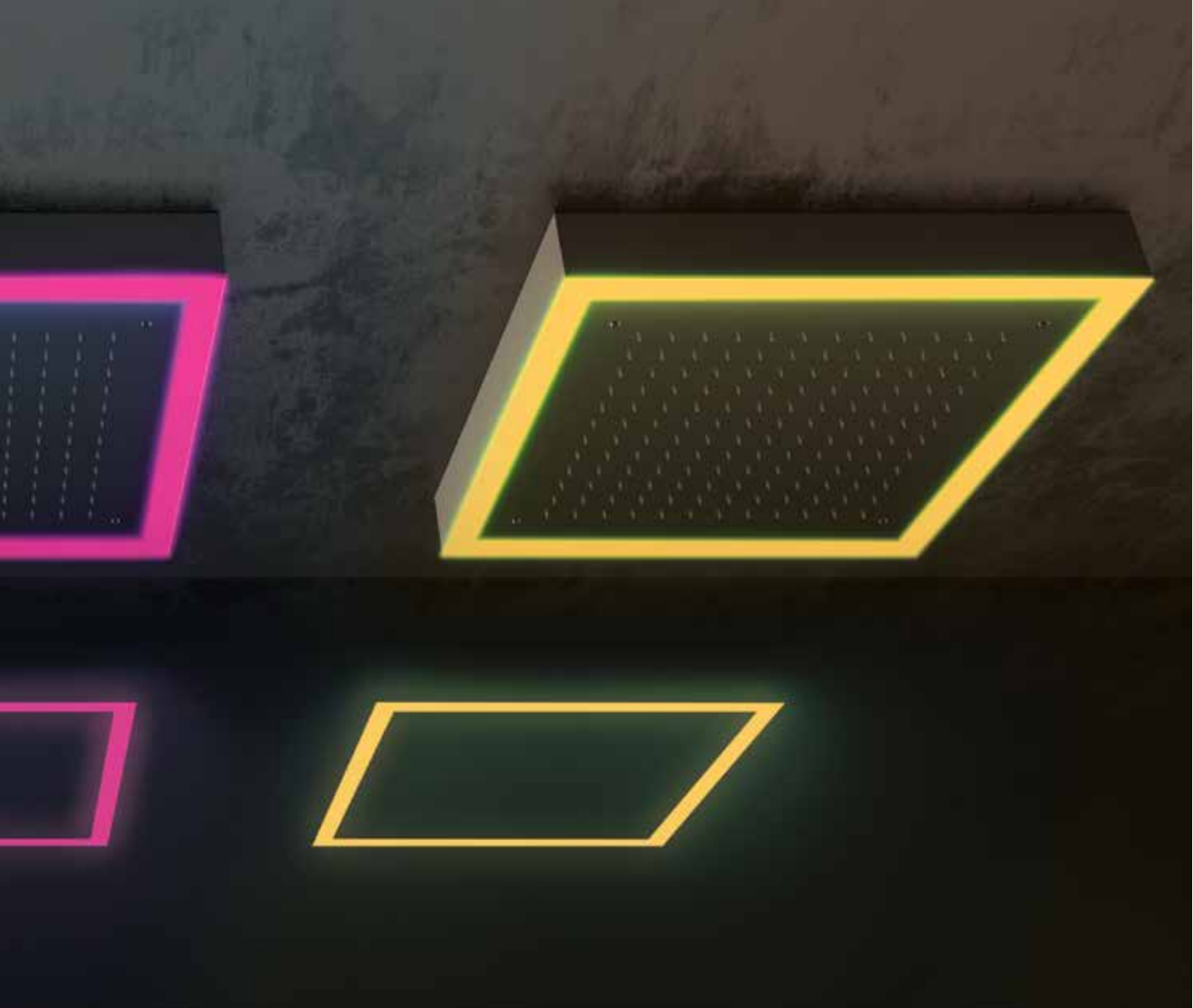

WELLNESS

BOX
INCASSO
BUILT-IN
BOX

WELLNESS
KIT

CROMOTERAPIA
COLOUR
THERAPIE

SOFFIONI
SHOWER
HEAD

PANNELLI
DOCCIA
SHOWER
PANELS

COLONNE
DOCCIA
SHOWER
COLUMN

SALISCENDI
SLIDING
RAILS

DOCCETTE
HAND
SHOWERS

OASIS
SHUT-OFF

BOCCE
SPOUTS

ACCESSORI
RUBINETTERIA
TAP
ACCESSORIES

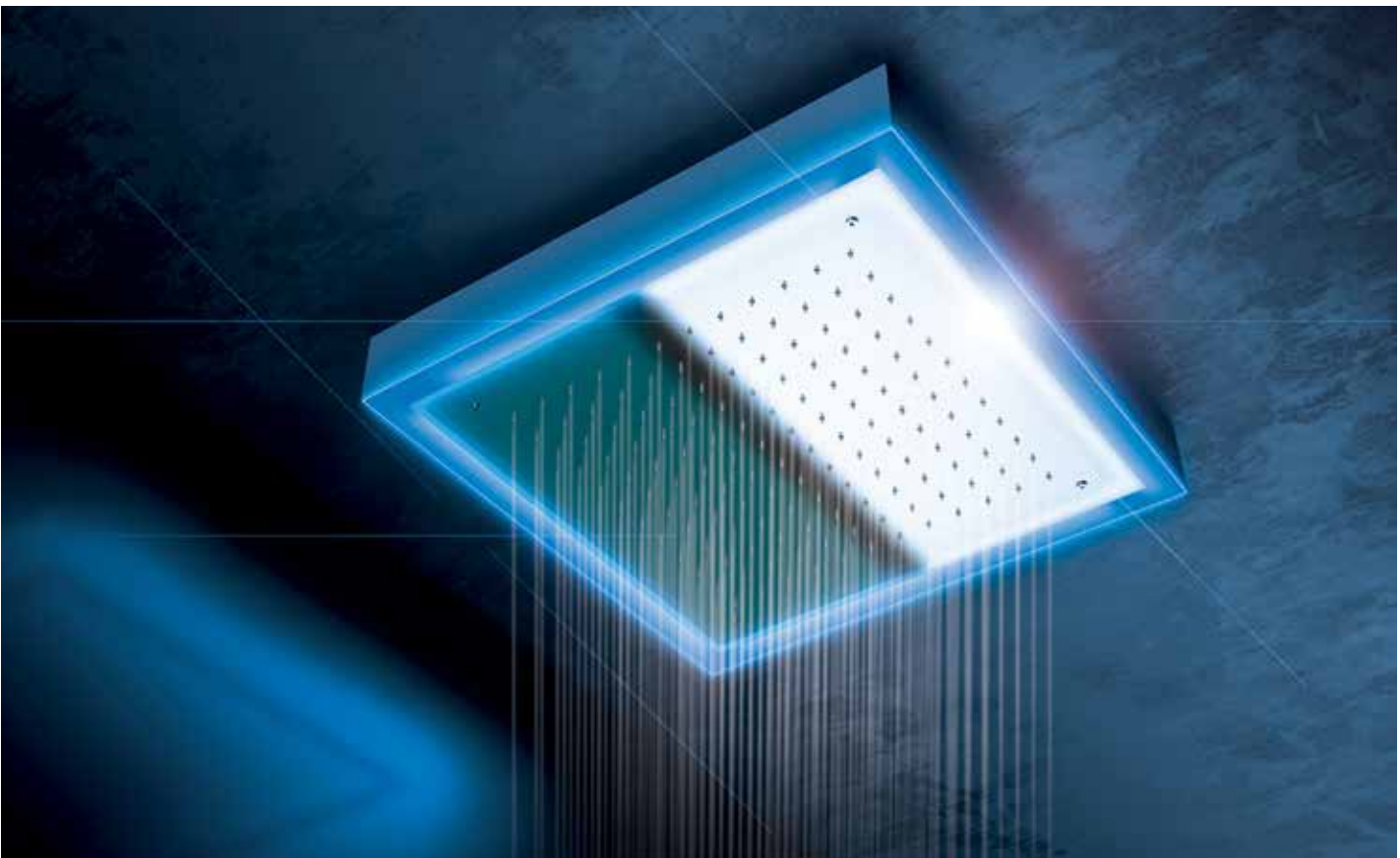

CROMOTERAPIA - COLOUR THERAPIE

IN DOTAZIONE AI MODELLI
SUPPLIED THE MODEL



Pulsantiera a parete per accensione luce bianca, selezione colori e cromoterapia automatica.
Wall push-button to turn on, and select the colors.



Pulsantiera wireless per accensione luce bianca, selezione colori e cromoterapia automatica.
Wireless push-button to turn on, and select the colors.

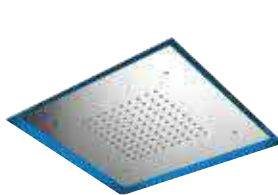

Soffione retroilluminato ad incasso in Acciaio INOX anti-calcare 57x57 cm, con getto a pioggia. Luce LED a 7 colori con 40 sfumature, alimentazione dalla rete elettrica con trasformatore a basso voltaggio incluso (12V).

Built-in stainless steel backlit antilimestone shower head 57x57 cm, with 1 rain jet. 7 colors light led with 40 shades. Powered by electricity with low voltage transformer included (12V).

A579AICM57

Pulsantiera a parete inclusa.
Wall push-button included.



A579AICM57W

con pulsantiera wireless inclusa.
with wireless remote control included.

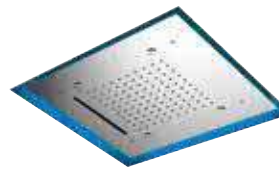

Soffione retroilluminato ad incasso in Acciaio INOX anti-calcare 57x57 cm, con 3 funzioni: getto a pioggia, nebulizzazione (4 uscite) ed 1 getto a cascata. Luce LED a 7 colori con 40 sfumature, alimentazione dalla rete elettrica con trasformatore a basso voltaggio incluso (12V).

Built-in stainless steel backlit antilimestone shower head 57x57 cm, with 3 functions: 1 rain jet nebulization (4 outlets) and 1 waterfall jet. 7 colors light led with 40 shades. Powered by electricity with low voltage transformer included (12V).

A579AICM57NC

Pulsantiera a parete inclusa.
Wall push-button included.



A579AICM57NCW

con pulsantiera wireless inclusa.
with wireless remote control included.

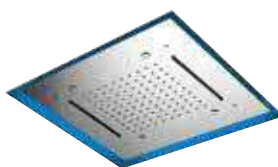

Soffione retroilluminato ad incasso in Acciaio INOX anti-calcare 57x57 cm, con 3 funzioni: getto a pioggia, nebulizzazione (4 uscite) e 2 getti a cascata. Luce LED a 7 colori con 40 sfumature, alimentazione dalla rete elettrica con trasformatore a basso voltaggio incluso (12V).

Built-in stainless steel backlit antilimestone shower head 57x57 cm, with 3 functions: 1 rain jet nebulization (4 outlets) and 2 waterfall jets. 7 colors light led with 40 shades. Powered by electricity with low voltage transformer included (12V).

A579AICM57N2C

Pulsantiera a parete inclusa.
Wall push-button included.



A579AICM57N2CW

con pulsantiera wireless inclusa.
with wireless remote control included.



IN DOTAZIONE AI MODELLI
SUPPLIED THE MODEL



Pulsantiera a parete
per accensione luce
bianca, selezione colori e
cromoterapia automatica.
*Wall push-button to turn on,
and select the colors.*



W

Pulsantiera wireless
per accensione luce
bianca, selezione colori e
cromoterapia automatica.
*Wireless push-button to turn
on, and select the colors.*



BOX
INCASSO
BUILT-IN
BOX

WELLNESS
KIT

CROMOTERAPIA
COLOUR
THERAPIE

SOFFIONI
SHOWER
HEAD

PANNELLI
DOCCIA
SHOWER
PANELS

COLONNE
DOCCIA
SHOWER
COLUMN

SALISCENDI
SLIDING
RAILS

DOCCETTE
HAND
SHOWERS

OASIS
SHUT-OFF

BOCCHE
SPOUTS

ACCESSORI
RUBINETTERIA
TAP
ACCESSORIES

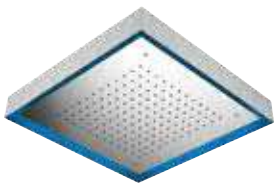

Soffione retroilluminato a soffitto in
Acciaio INOX anti-calcare 57x57 cm,
con getto a pioggia. Luce LED a 7 colori
con 40 sfumature, alimentazione dalla
rete elettrica con trasformatore a basso
voltaggio incluso (12V).

*Ceiling stainless steel backlit
antilimestone shower head 57x57 cm,
with 1 rain jet. 7 colors light led with 40 shades. Powered by electricity
with low voltage transformer included (12V).*

A579ALCM57

Pulsantiera a parete inclusa.

Wall push-button included.



A579ALCM57W

con pulsantiera wireless inclusa.

with wireless remote control included.

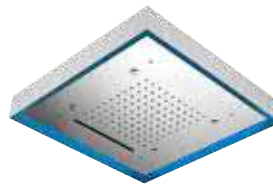

Soffione retroilluminato a soffitto in
Acciaio INOX anti-calcare 57x57 cm, con
3 funzioni: getto a pioggia, nebulizzazione
(4 uscite) ed 1 getto a cascata. Luce
LED a 7 colori con 40 sfumature,
alimentazione dalla rete elettrica con
trasformatore a basso voltaggio incluso
(12V).

*Ceiling stainless steel backlit
antilimestone shower head 57x57 cm,
with 3 functions: 1 rain jet nebulization (4 outlets) and 1 waterfall jet. 7
colors light led with 40 shades. Powered by electricity with low voltage
transformer included (12V).*

A579ALCM57NC

Pulsantiera a parete inclusa.

Wall push-button included.



A579ALCM57NCW

con pulsantiera wireless inclusa.

with wireless remote control included.

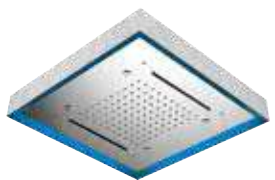

Soffione retroilluminato a soffitto in
Acciaio INOX anti-calcare 57x57 cm, con
3 funzioni: getto a pioggia, nebulizzazione
(4 uscite) e 2 getti a cascata. Luce LED a
7 colori con 40 sfumature, alimentazione
dalla rete elettrica con trasformatore a
basso voltaggio incluso (12V).

*Ceiling stainless steel backlit
antilimestone shower head 57x57
cm, with 3 functions: 1 rain jet nebulization (4 outlets) and 2 waterfall
jets. 7 colors light led with 40 shades. Powered by electricity with
low voltage transformer included (12V).*

A579ALCM57N2C

Pulsantiera a parete inclusa.

Wall push-button included.



A579ALCM57N2CW

con pulsantiera wireless inclusa.

with wireless remote control included.



CROMOTERAPIA - COLOUR THERAPIE

IN DOTAZIONE AI MODELLI
SUPPLIED THE MODEL



Pulsantiera a parete per accensione luce bianca, selezione colori e cromoterapia automatica.
Wall push-botton to turn on, and select the colors.



W

Pulsantiera wireless per accensione luce bianca, selezione colori e cromoterapia automatica.
Wireless push-botton to turn on, and select the colors..

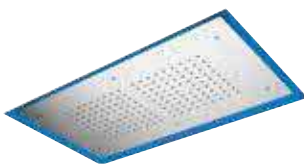

Soffione retroilluminato ad incasso in Acciaio INOX anti-calcare 77x47 cm, con 2 postazioni pioggia. Luce LED a 7 colori con 40 sfumature, alimentazione dalla rete elettrica con trasformatore a basso voltaggio incluso (12V).

Built-in stainless steel backlighted antilimestone shower head 77x47 cm, with 2 workstations rain jet. 7 colors light led with 40 shades. Powered by electricity with low voltage transformer included (12V).

A579RAI7747



Pulsantiera a parete inclusa.

Wall push-botton included.

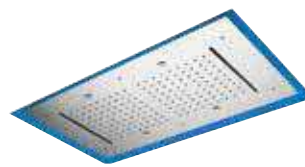

Soffione ad incasso in Acciaio INOX 77x47 cm, con 3 funzioni: 2 getti cascata, nebulizzazione (4 uscite) e 2 postazioni pioggia. Luce LED a 7 colori con 40 sfumature, alimentazione dalla rete elettrica con trasformatore a basso voltaggio incluso (12V).

Built-in stainless steel backlighted antilimestone shower head 77x47 cm, with 3 functions: 2 workstations rain jet, nebulization (4 outlets) and 2 waterfall jets. 7 colors light led with 40 shades. Powered by electricity with low voltage transformer included (12V).

A579RAI7747N2C



Pulsantiera a parete inclusa.

Wall push-botton included.



A579RAI7747W



con pulsantiera wireless inclusa.

with wireless remote control included.



A579RAI7747N2CW



con pulsantiera wireless inclusa.

with wireless remote control included.



IN DOTAZIONE AI MODELLI
SUPPLIED THE MODEL



Pulsantiera a parete
per accensione luce
bianca, selezione colori e
cromoterapia automatica.
*Wall push-button to turn on,
and select the colors.*



W

Pulsantiera wireless
per accensione luce
bianca, selezione colori e
cromoterapia automatica.
*Wireless push-button to turn
on, and select the colors.*



BOX
INCASSO
BUILT-IN
BOX

WELLNESS
KIT

CROMOTERAPIA
COLOUR
THERAPIE

SOFFIONI
SHOWER
HEAD

PANNELLI
DOCCIA
SHOWER
PANELS

COLONNE
DOCCIA
SHOWER
COLUMN

SALISCENDI
SLIDING
RAILS

DOCCETTE
HAND
SHOWERS

OASIS
SHUT-OFF

BOCCHE
SPOUTS

ACCESSORI
RUBINETTERIA
TAP
ACCESSORIES



Soffione retroilluminato a soffitto
in Acciaio INOX anti-calcare 77x47
cm, con 2 postazioni pioggia. Luce
LED a 7 colori con 40 sfumature,
alimentazione dalla rete elettrica
con trasformatore a basso voltaggio
incluso (12V).

*Ceiling stainless steel backlit
antilimestone shower head 77x47 cm,
with 2 workstations rain jet.
7 colors light led with 40 shades.
Powered by electricity with low
voltage transformer included (12V).*

A579RAL7747



Pulsantiera a parete inclusa.

Wall push-button included.

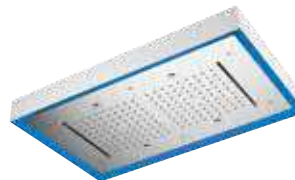

Soffione a soffitto in Acciaio INOX
77x47 cm, con 3 funzioni: 2 getti
cascata, nebulizzazione (4 uscite) e 2
postazioni pioggia. Luce LED a 7 colori
con 40 sfumature, alimentazione dalla
rete elettrica con trasformatore a
basso voltaggio incluso (12V).

*Ceiling stainless steel backlit
antilimestone shower head 77x47 cm,
with 3 functions: 2 workstations rain jet,
nebulization (4 outlets) and 2
waterfall jets. 7 colors light led with 40
shades. Powered by electricity
with low voltage transformer included (12V).*

A579RAL7747N2C



Pulsantiera a parete inclusa.

Wall push-button included.



A579RAL7747W



con pulsantiera wireless inclusa.

with wireless remote control included.



A579RAL7747N2CW



con pulsantiera wireless inclusa.

*with wireless remote control
included.*



CROMOTERAPIA - COLOUR THERAPIE

IN DOTAZIONE AI MODELLI
SUPPLIED THE MODEL



Pulsantiera a parete per accensione luce bianca, selezione colori e cromoterapia automatica.
Wall push-botton to turn on, and select the colors.



W

Pulsantiera wireless per accensione luce bianca, selezione colori e cromoterapia automatica.
Wireless push-botton to turn on, and select the colors.



Soffione retroilluminato ad incasso in Acciaio INOX anti-calcare Ø57 cm, getto pioggia. Luce LED a 7 colori con 40 sfumature, alimentazione dalla rete elettrica con trasformatore a basso voltaggio incluso (12V).

Built-in stainless steel backlighted antilimestone shower head Ø57 cm, with rain jet. 7 colors light led with 40 shades. Powered by electricity with low voltage transformer included (12V).

A578AICM57



Pulsantiera a parete inclusa.

Wall push-botton included.



Soffione retroilluminato ad incasso in Acciaio INOX anti-calcare Ø57 cm, con 2 funzioni: getto pioggia e nebulizzazione (4 uscite). Luce LED a 7 colori con 40 sfumature, alimentazione dalla rete elettrica con trasformatore a basso voltaggio incluso (12V).

Built-in stainless steel backlighted antilimestone shower head Ø57 cm, with 2 functions: rain jet and nebulization (4 outlets). 7 colors light led with 40 shades. Powered by electricity with low voltage transformer included (12V).

A578AICM57N



Pulsantiera a parete inclusa.

Wall push-botton included.



A578AICM57W



con pulsantiera wireless inclusa.

with wireless remote control included.



A578AICM57NW



con pulsantiera wireless inclusa.

with wireless remote control included.



IN DOTAZIONE AI MODELLI
SUPPLIED THE MODEL



Pulsantiera a parete
per accensione luce
bianca, selezione colori e
cromoterapia automatica.
*Wall push-button to turn on,
and select the colors.*



W

Pulsantiera wireless
per accensione luce
bianca, selezione colori e
cromoterapia automatica.
*Wireless push-button to turn
on, and select the colors.*

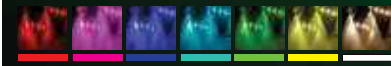

BOX
INCASSO
BUILT-IN
BOX

WELLNESS
KIT

CROMOTERAPIA
COLOUR
THERAPIE

SOFFIONI
SHOWER
HEAD

PANNELLI
DOCCIA
SHOWER
PANELS

COLONNE
DOCCIA
SHOWER
COLUMN

SALISCENDI
SLIDING RAILS

DOCCETTE
HAND
SHOWERS

OASIS
SHUT-OFF

BOCCHE
SPOUTS

ACCESSORI
RUBINETTERIA
TAP
ACCESSORIES



Soffione retroilluminato a soffitto in
Acciaio INOX anti-calcare Ø57 cm,
getto pioggia. Luce LED a 7 colori con
40 sfumature, alimentazione dalla rete
elettrica con trasformatore a basso
voltaggio incluso (12V).

*Ceiling stainless steel backlighted antilimestone shower head Ø57
cm, with rain jet. 7 colors light led with 40 shades. Powered by
electricity with low voltage transformer included (12V).*

A578ALCM57



Pulsantiera a parete inclusa.

Wall push-button included.



Soffione retroilluminato a soffitto in
Acciaio INOX anti-calcare Ø57 cm, con
2 funzioni: getto pioggia e nebulizzazione
(4 uscite). Luce LED a 7 colori con 40
sfumature, alimentazione dalla rete
elettrica con trasformatore a basso
voltaggio incluso (12V).

*Ceiling stainless steel backlighted antilimestone shower head Ø57
cm, with 2 functions: rain jet and nebulization (4 outlets). 7 colors
light led with 40 shades. Powered by electricity with low voltage
transformer included (12V).*

A578ALCM57N



Pulsantiera a parete inclusa.

Wall push-button included.



A578ALCM57W



con pulsantiera wireless inclusa.

with wireless remote control included.



A578ALCM57NW



con pulsantiera wireless inclusa.

with wireless remote control included.



CROMOTERAPIA - COLOUR THERAPIE

IN DOTAZIONE AI MODELLI
SUPPLIED THE MODEL



Pulsantiera a parete per accensione luce bianca, selezione colori e cromoterapia automatica. *Wall push-botton to turn on, and select the colors.*



Pulsantiera wireless per accensione luce bianca, selezione colori e cromoterapia automatica. *Wireless push-botton to turn on, and select the colors.*



Soffione a soffitto in Acciaio INOX lucidato a specchio 43x43 cm, con getto a pioggia. Luce LED a 7 colori con 40 sfumature, alimentazione dalla rete elettrica con trasformatore a basso voltaggio incluso (12V). *Ceiling stainless steel mirror polished shower head 43x43 cm, rain jet. 7 colors light led with 40 shades. Powered by electricity with low voltage transformer included (12V).*

A579JCM43

Pulsantiera a parete inclusa. *Wall push-botton included.*



A579JCM43W

con pulsantiera wireless inclusa. *with wireless remote control included.*



Soffione a soffitto in Acciaio INOX lucidato a specchio 50x50 cm, con getto a pioggia. Luce LED a 7 colori con 40 sfumature, alimentazione dalla rete elettrica con trasformatore a basso voltaggio incluso (12V). *Ceiling stainless steel mirror polished shower head 50x50 cm, rain jet. 7 colors light led with 40 shades. Powered by electricity with low voltage transformer included (12V).*

A579JCM50

Pulsantiera a parete inclusa. *Wall push-botton included.*



A579JCM50W

con pulsantiera wireless inclusa. *with wireless remote control included.*



Soffione a soffitto in Acciaio INOX lucidato a specchio 43x43 cm, con 3 funzioni: 1 getto a pioggia, nebulizzazione (4 uscite) ed 1 getto a cascata. Luce LED a 7 colori con 40 sfumature, alimentazione dalla rete elettrica con trasformatore a basso voltaggio incluso (12V). *Ceiling stainless steel mirror polished shower head 43x43 cm 3 functions: 1, rain jet, nebulization (4 outlets) and 1 waterfall jet. 7 colors light led with 40 shades. Powered by electricity with low voltage transformer included (12V).*

A579JCM43NC

Pulsantiera a parete inclusa. *Wall push-botton included.*



A579JCM43NCW

con pulsantiera wireless inclusa. *with wireless remote control included.*



Soffione a soffitto in Acciaio INOX lucidato a specchio 50x50 cm, con 3 funzioni: 1 getto a pioggia, nebulizzazione (4 uscite) ed 1 getto a cascata. Luce LED a 7 colori con 40 sfumature, alimentazione dalla rete elettrica con trasformatore a basso voltaggio incluso (12V). *Ceiling stainless steel mirror polished shower head 50x50 cm 3 functions: 1, rain jet, nebulization (4 outlets) and 1 waterfall jet. 7 colors light led with 40 shades. Powered by electricity with low voltage transformer included (12V).*

A579JCM50NC

Pulsantiera a parete inclusa. *Wall push-botton included.*



A579JCM50NCW

con pulsantiera wireless inclusa. *with wireless remote control included.*



IN DOTAZIONE AI MODELLI
SUPPLIED THE MODEL



Pulsantiera a parete
per accensione luce
bianca, selezione colori e
cromoterapia automatica.
*Wall push-button to turn on,
and select the colors.*



W

Pulsantiera wireless
per accensione luce
bianca, selezione colori e
cromoterapia automatica.
*Wireless push-button to turn
on, and select the colors.*

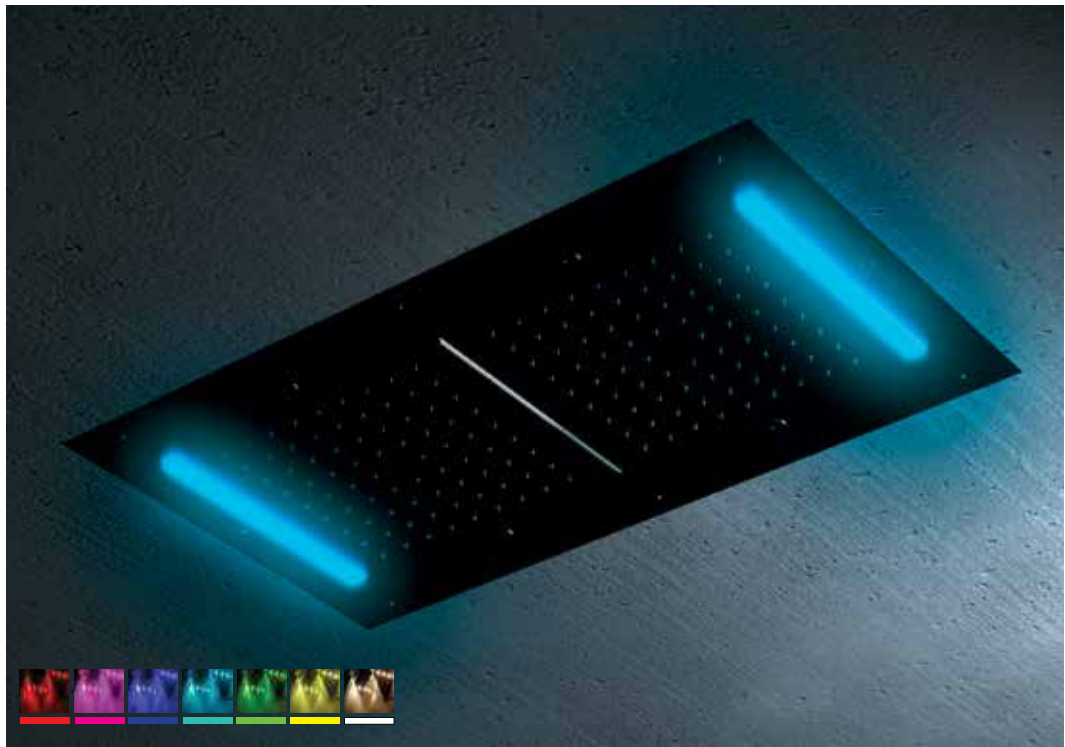
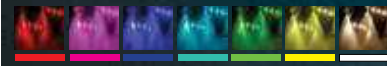

BOX
INCASSO
BUILT-IN
BOX

WELLNESS
KIT

CROMOTERAPIA
COLOUR
THERAPIE

SOFFIONI
SHOWER
HEAD

PANNELLI
DOCCIA
SHOWER
PANELS

COLONNE
DOCCIA
SHOWER
COLUMN

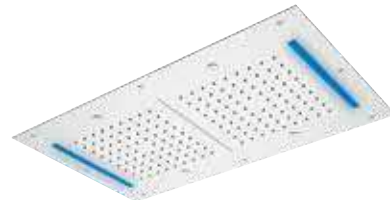
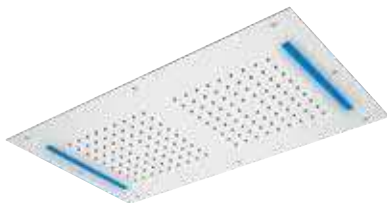

Soffione a incasso in Acciaio INOX lucidato a specchio 70x40 cm, con 2 postazioni getto a pioggia. Luce LED a 7 colori con 40 sfumature, alimentazione dalla rete elettrica con trasformatore a basso voltaggio incluso (12V).

Built-in stainless steel mirror polished shower head 70x40 cm, 2 rain jet workstations, 7 colors light led with 40 shades. Powered by electricity with low voltage transformer included (12V).

A579RJ7040



Pulsantiera a parete inclusa.

Wall push-button included.



A579RJ7040NC



Pulsantiera a parete inclusa.

Wall push-button included.



A579RJ7040W



con pulsantiera wireless inclusa.

with wireless remote control included.



A579RJ7040NCW



con pulsantiera wireless inclusa.

with wireless remote control included.



SALISCENDI
SLIDING RAILS

DOCCETTE
HAND
SHOWERS

OASIS
SHUT-OFF

BOCCH
SPOUTS

ACCESSORI
RUBINETTERIA
TAP
ACCESSORIES

CROMOTERAPIA - COLOUR THERAPIE

IN DOTAZIONE AI MODELLI
SUPPLIED THE MODEL



Pulsantiera a parete per accensione luce bianca, selezione colori e cromoterapia automatica.
Wall push-button to turn on, and select the colors.



Pulsantiera wireless per accensione luce bianca, selezione colori e cromoterapia automatica.
Wireless push-button to turn on, and select the colors.



Soffione a soffitto in Acciaio INOX lucidato a specchio Ø 42 cm, con getto a pioggia. Luce LED a 7 colori con 40 sfumature, alimentazione dalla rete elettrica con trasformatore a basso voltaggio incluso (12V).
Ceiling stainless steel mirror polished shower head Ø 42 cm, rain jet. 7 colors light led with 40 shades. Powered by electricity with low voltage transformer included (12V).

A578JCM42



Pulsantiera a parete inclusa.

Wall push-button included.



A578JCM42W



con pulsantiera wireless inclusa.

with wireless remote control included.



Soffione a soffitto in Acciaio INOX lucidato a specchio Ø 55 cm, con getto a pioggia. Luce LED a 7 colori con 40 sfumature, alimentazione dalla rete elettrica con trasformatore a basso voltaggio incluso (12V).
Ceiling stainless steel mirror polished shower head Ø 55 cm, rain jet. 7 colors light led with 40 shades. Powered by electricity with low voltage transformer included (12V).

A578JCM55



Pulsantiera a parete inclusa.

Wall push-button included.



A578JCM55W



con pulsantiera wireless inclusa.

with wireless remote control included.



Soffione a soffitto in Acciaio INOX lucidato a specchio Ø 42 cm, con 2 getti: 1 getto a pioggia, 4 getti nebulizzati. Luce LED a 7 colori con 40 sfumature, alimentazione dalla rete elettrica con trasformatore a basso voltaggio incluso (12V).
Ceiling stainless steel mirror polished shower head Ø 42 cm 2 jets: 1, rain jet, nebulization (4 outlets). 7 colors light led with 40 shades. Powered by electricity with low voltage transformer included (12V).

A578JCM42N



Pulsantiera a parete inclusa.

Wall push-button included.



A578JCM42NW



con pulsantiera wireless inclusa.

with wireless remote control included.



Soffione a soffitto in Acciaio INOX lucidato a specchio Ø 55 cm, con 2 getti: 1 getto a pioggia, 4 getti nebulizzati. Luce LED a 7 colori con 40 sfumature, alimentazione dalla rete elettrica con trasformatore a basso voltaggio incluso (12V).
Ceiling stainless steel mirror polished shower head Ø 55 cm 2 jets: 1, rain jet, nebulization (4 outlets). 7 colors light led with 40 shades. Powered by electricity with low voltage transformer included (12V).

A578JCM55N



Pulsantiera a parete inclusa.

Wall push-button included.



A578JCM55NW



con pulsantiera wireless inclusa.

with wireless remote control included.



IN DOTAZIONE AI MODELLI
SUPPLIED THE MODEL



Pulsantiera a parete
per accensione luce
bianca, selezione colori e
cromoterapia automatica.
*Wall push-button to turn on,
and select the colors.*



W

Pulsantiera wireless
per accensione luce
bianca, selezione colori e
cromoterapia automatica.
*Wireless push-button to turn
on, and select the colors.*

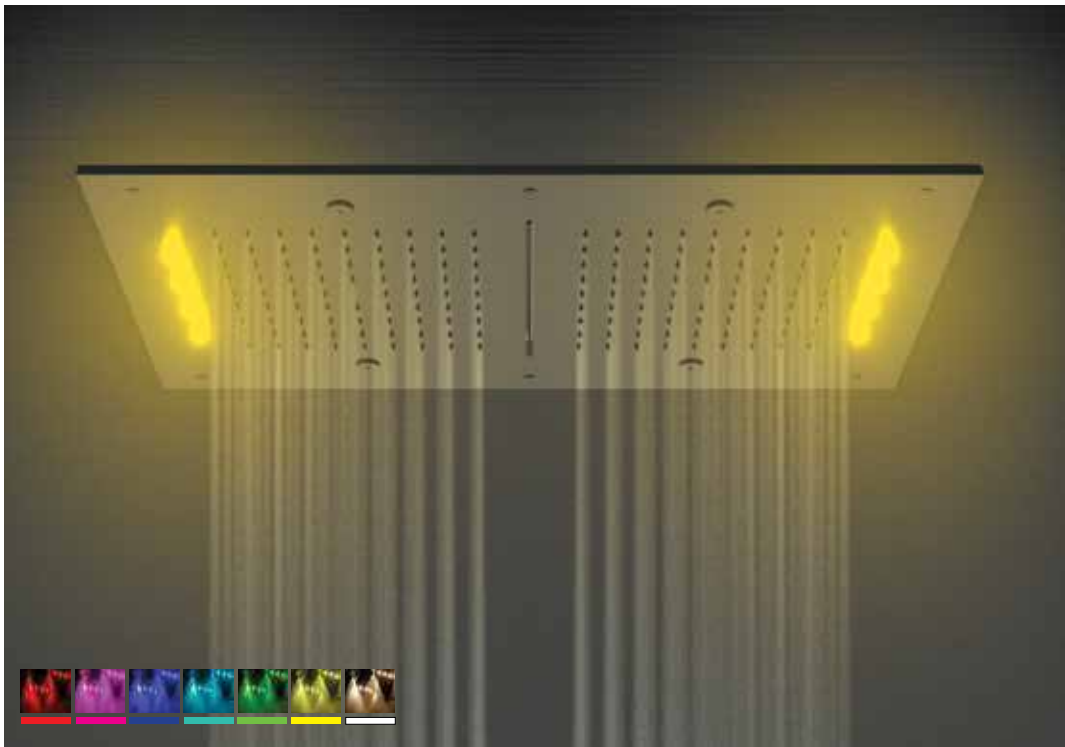

BOX
INCASSO
BUILT-IN
BOX

WELLNESS
KIT

CROMOTERAPIA
COLOUR
THERAPIE

SOFFIONI
SHOWER
HEAD

PANNELLI
DOCCIA
SHOWER
PANELS

COLONNE
DOCCIA
SHOWER
COLUMN

SALISCENDI
SLIDING
RAILS

DOCCETTE
HAND
SHOWERS

OASIS
SHUT-OFF

BOCCHE
SPOUTS

ACCESSORI
RUBINETTERIA
TAP
ACCESSORIES



Soffione a incasso in Acciaio INOX lucidato a specchio 50x50x1 cm, 1 postazione pioggia, 1 getto a cascata, 4 getti nebulizzati. Luce LED a 7 colori con 40 sfumature, alimentazione dalla rete elettrica con trasformatore a basso voltaggio incluso (12V).

Ceiling built-in stainless steel mirror polished shower head 50x50x5 cm, 1 rain jet workstation, 1 waterfall jet, nebulization (4 outlets). 7 colors light led with 40 shades. Powered by electricity with low voltage transformer included (12V).

A579LE1CM50NC



Pulsantiera a parete inclusa.

Wall push-button included.



Soffione a incasso in Acciaio INOX lucidato a specchio 70x40x1 cm, 2 postazioni pioggia, 1 getto a cascata centrale, 4 getti nebulizzati. Luce LED a 7 colori con 40 sfumature, alimentazione dalla rete elettrica con

*trasformatore a basso voltaggio incluso (12V).
Ceiling built-in stainless steel mirror polished shower head 70x40x5 cm, 2 rain jet workstations, 1 central waterfall jet, nebulization (4 outlets). 7 colors light led with 40 shades. Powered by electricity with low voltage transformer included (12V).*

A579RLE17040NC



Pulsantiera a parete inclusa.

Wall push-button included.



A579LE1CM50NCW



con pulsantiera wireless inclusa.

with wireless remote control included.



A579LE1CM50NCW



con pulsantiera wireless inclusa.

with wireless remote control included.



CROMOTERAPIA - COLOUR THERAPIE

IN DOTAZIONE AI MODELLI
SUPPLIED THE MODEL



Pulsantiera a parete per accensione luce bianca, selezione colori e cromoterapia automatica.
Wall push-button to turn on, and select the colors.



Pulsantiera wireless per accensione luce bianca, selezione colori e cromoterapia automatica.
Wireless push-button to turn on, and select the colors.

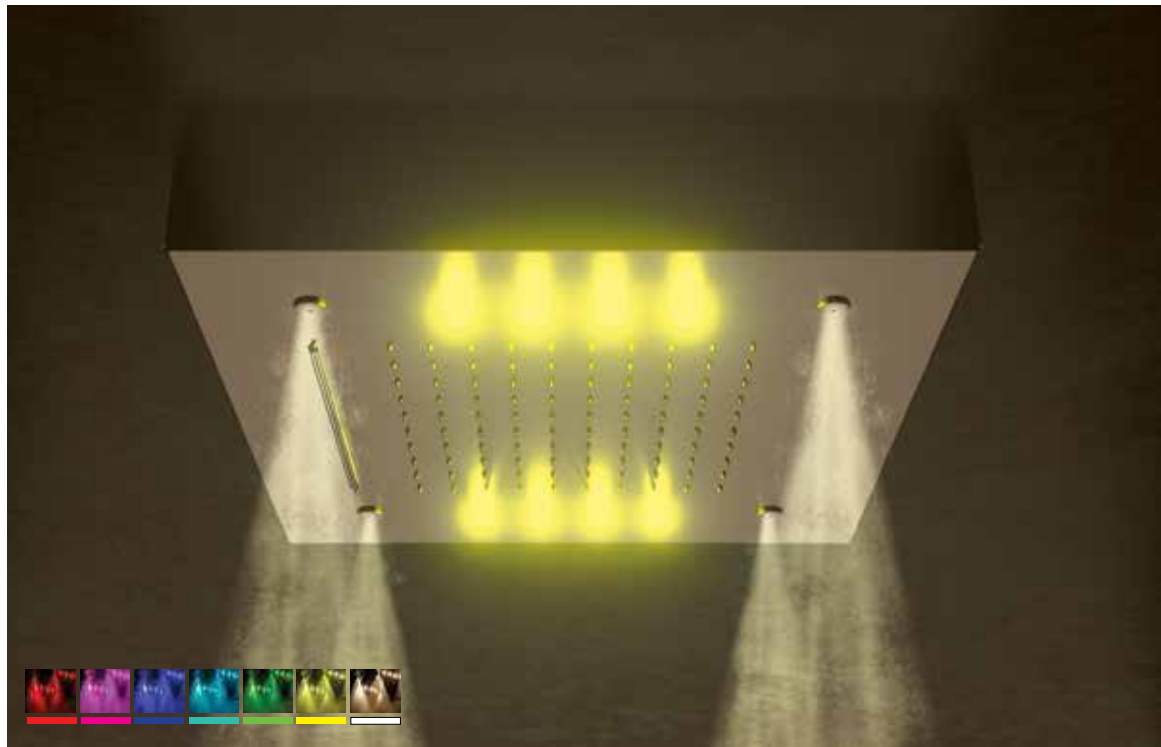

Soffione a soffitto in Acciaio INOX lucidato a specchio 50x50x5 cm, 1 postazione pioggia, 1 getto a cascata, 4 getti nebulizzati. Luce LED a 7 colori con 40 sfumature, alimentazione dalla rete elettrica con trasformatore a basso voltaggio incluso (12V).

Ceiling stainless steel mirror polished shower head 50x50x5 cm, 1 rain jet workstation, 1 waterfall jet, nebulization (4 outlets). 7 colors light led with 40 shades. Powered by electricity with low voltage transformer included (12V).

A579LE5CM50NC



Pulsantiera a parete inclusa.

Wall push-button included.



Soffione a soffitto in Acciaio INOX lucidato a specchio 70x40x5 cm, 2 postazioni pioggia, 1 getto a cascata centrale, 4 getti nebulizzati. Luce LED a 7 colori con 40 sfumature, alimentazione dalla rete elettrica con trasformatore a basso voltaggio incluso (12V).

Ceiling stainless steel mirror polished shower head 70x40x5 cm, 2 rain jet workstations, 1 central waterfall jet, nebulization (4 outlets). 7 colors light led with 40 shades. Powered by electricity with low voltage transformer included (12V).

A579RLE57040NC



Pulsantiera a parete inclusa.

Wall push-button included.



A579LE5CM50NCW



con pulsantiera wireless inclusa.

with wireless remote control included.



A579RLE57040NCW



con pulsantiera wireless inclusa.

with wireless remote control included.



IN DOTAZIONE AI MODELLI
SUPPLIED THE MODEL



Pulsantiera a parete
per accensione luce
bianca, selezione colori e
cromoterapia automatica.
*Wall push-botton to turn on,
and select the colors.*



W

Pulsantiera wireless
per accensione luce
bianca, selezione colori e
cromoterapia automatica.
*Wireless push-botton to turn
on, and select the colors.*



BOX
INCASSO
BUILT-IN
BOX

WELLNESS
KIT

CROMOTERAPIA
COLOUR
THERAPIE

SOFFIONI
SHOWER
HEAD

PANNELLI
DOCCIA
SHOWER
PANELS

COLONNE
DOCCIA
SHOWER
COLUMN

SALISCENDI
SLIDING
RAILS

DOCCETTE
HAND
SHOWERS

OASIS
SHUT-OFF

BOCCHE
SPOUTS

ACCESSORI
RUBINETTERIA
TAP
ACCESSORIES



Soffione a parete in Acciaio INOX
lucidato a specchio 50x26x6,4
cm, con 1 postazione pioggia ed 1 getto
a cascata. Luce LED a 7 colori con 40
sfumature, alimentazione dalla rete elettrica
con trasformatore a basso voltaggio
incluso (12V).

Wall stainless steel mirror polished shower head 50x26x6,4 cm, 1 rain jet workstation. 7 colors light led with 40 shades. Powered by electricity with low voltage transformer included (12V).

A562L



Pulsantiera a parete inclusa.

Wall push-botton included.

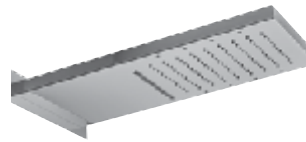

Soffione a parete in Acciaio INOX
lucidato a specchio 50x26x6,4 cm,
con 1 postazione pioggia ed 1 getto
a cascata. Luce LED a 7 colori con 40
sfumature, alimentazione dalla rete
elettrica con trasformatore a basso
voltaggio incluso (12V).

Wall stainless steel mirror polished shower head 50x26x6,4 cm, 1 rain jet workstation and waterfall jet. 7 colors light led with 40 shades. Powered by electricity with low voltage transformer included (12V).

A562LCA



Pulsantiera a parete inclusa.

Wall push-botton included.



A562LW



con pulsantiera wireless inclusa.

with wireless remote control included.



A562LCAW



con pulsantiera wireless inclusa.

with wireless remote control included.





SOFFIONI HEAD SHOWERS

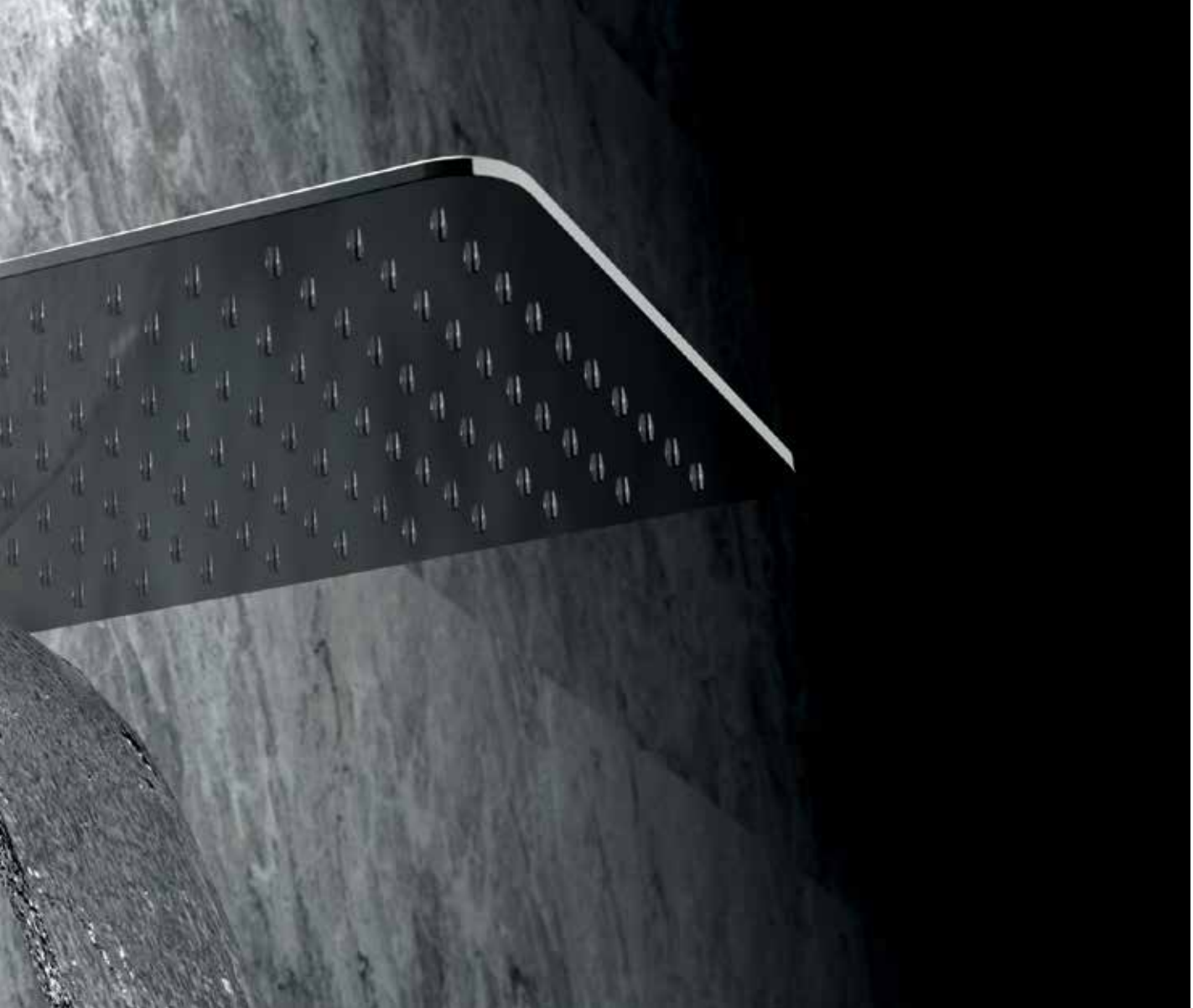

WELLNESS

BOX
INCASSO
BUILT-IN
BOX

WELLNESS
KIT

CROMOTERAPIA
COLOUR
THERAPIE

SOFFIONI
SHOWER
HEAD

PANNELLI
DOCCIA
SHOWER
PANELS

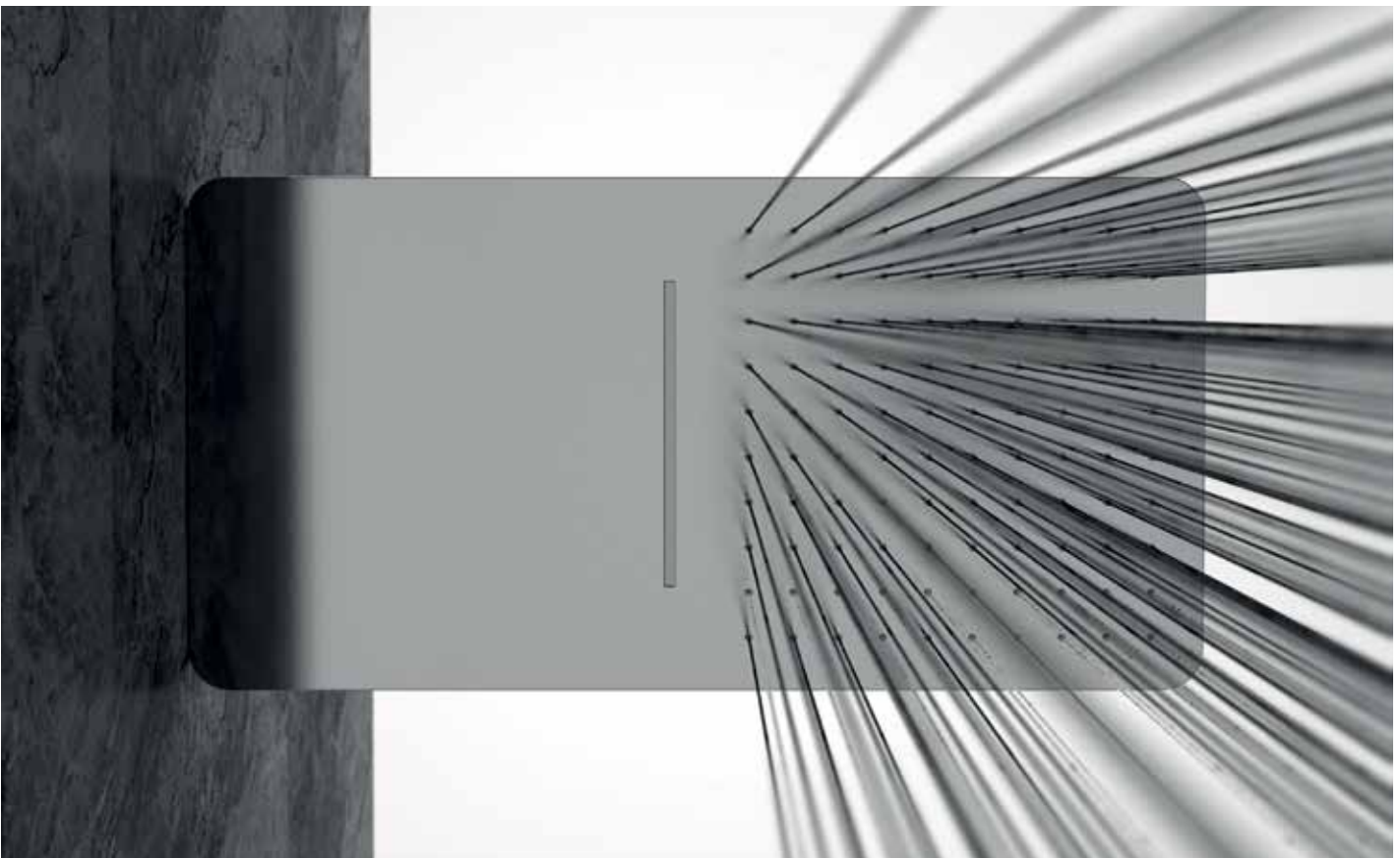

COLONNE
DOCCIA
SHOWER
COLUMN

SAISCENDI
SLIDING
RAILS

DOCCETTE
HAND
SHOWERS

OASIS
SHUT-OFF

BOCCH
SPOUTS

ACCESSORI
RUBINETTERIA
TAP
ACCESSORIES



A579SFCM30

Soffione a soffitto in Acciaio INOX lucidato a specchio con sistema anticalcare, 30x30 cm con getto a pioggia.
Ceiling stainless steel mirror polished shower head with antilimestone system, 30x30 cm, with rain jet.



A579SFCM43

Soffione a soffitto in Acciaio INOX lucidato a specchio con sistema anticalcare, 43x43 cm con getto a pioggia.
Ceiling stainless steel mirror polished shower head with antilimestone system, 43x43 cm, with rain jet.



A579SFCM50

Soffione a soffitto in Acciaio INOX lucidato a specchio con sistema anticalcare, 50x50 cm con getto a pioggia.
Ceiling stainless steel mirror polished shower head with antilimestone system, 50x50 cm, with rain jet.



A579SFCM43C

Soffione a soffitto in Acciaio INOX lucidato a specchio con sistema anticalcare, 43x43 cm, a 2 funzioni: getto a pioggia e cascata.
Ceiling stainless steel mirror polished shower head with antilimestone system, 43x43 cm, 2 functions: rain and waterfall jets.



A579SFCM50C

Soffione a soffitto in Acciaio INOX lucidato a specchio con sistema anticalcare, 50x50 cm, a 2 funzioni: getto a pioggia e cascata.
Ceiling stainless steel mirror polished shower head with antilimestone system, 50x50 cm, 2 functions: rain and waterfall jets.



A579SFCM43NC

Soffione a soffitto in Acciaio INOX lucidato a specchio con sistema anticalcare, 43x43 cm, a 3 funzioni: getto a pioggia, nebulizzazione (4 uscite) ed 1 getto a cascata.
Ceiling stainless steel mirror polished shower head with antilimestone system, 43x43 cm, 3 functions: rain jet, nebulization (4 outlet) and waterfall jet.



A579SFCM50NC

Soffione a soffitto in Acciaio INOX lucidato a specchio con sistema anticalcare, 50x50 cm, a 3 funzioni: getto a pioggia, nebulizzazione (4 uscite) ed 1 getto a cascata.
Ceiling stainless steel mirror polished shower head with antilimestone system, 50x50 cm, 3 functions: rain jet, nebulization (4 outlet) and waterfall jet.

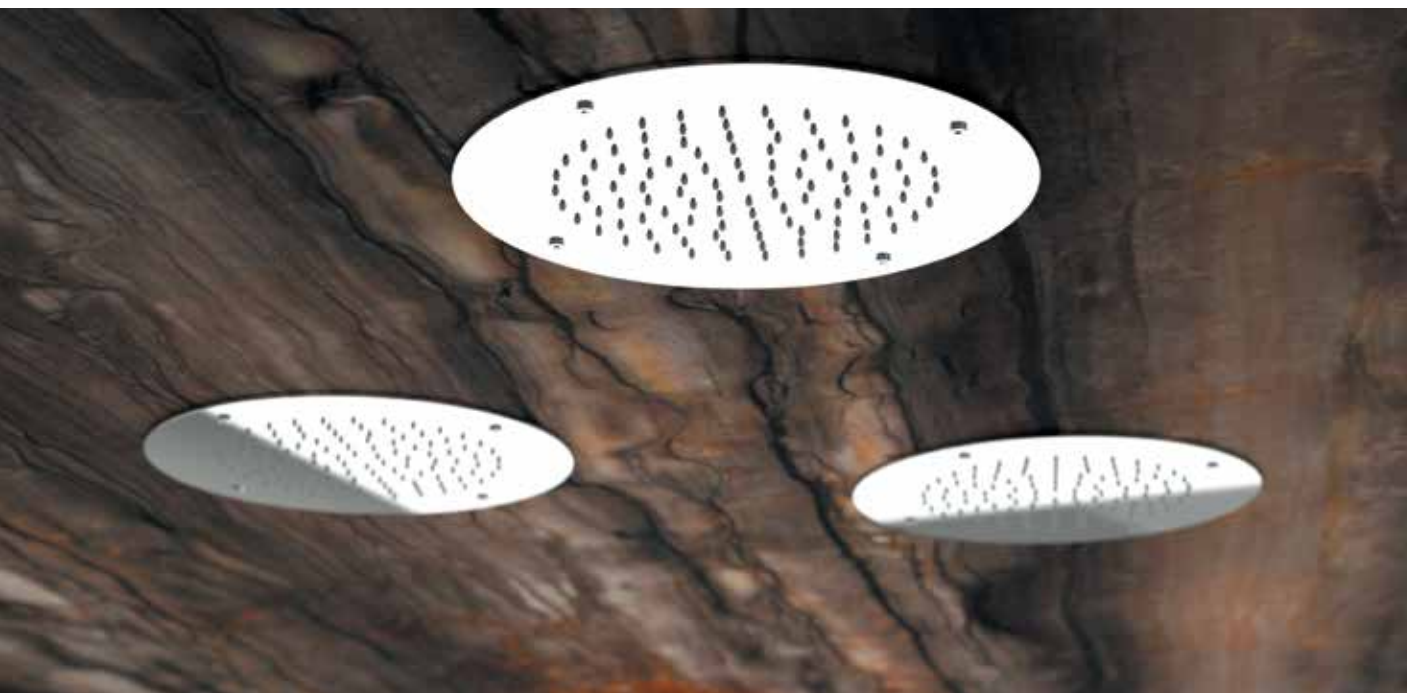
BOX
INCASSO
BUILT-IN
BOXWELLNESS
KITCROMOTERAPIA
COLOUR
THERAPIESOFFIONI
SHOWER
HEADPANNELLI
DOCCIA
SHOWER
PANELSCOLONNE
DOCCIA
SHOWER
COLUMNSALISCENDI
SLIDING
RAILSDOCCETTE
HAND
SHOWERSOASIS
SHUT-OFFBOCCHIE
SPOUTSACCESSORI
RUBINETTERIA
TAP
ACCESSORIES**A579RSF7040**

Soffione a soffitto in Acciaio INOX con sistema anti-calcare, 70x40 cm, 2 postazioni pioggia.
Ceiling stainless steel mirror polished shower head with antilimestone system 70x40 cm, with 2 rain jet workstations.

**A579RSF7040C**

Soffione a soffitto in Acciaio INOX con sistema anti-calcare, 70x40 cm, a 2 funzioni: 2 postazioni pioggia, ed un getto a cascata centrale.
Ceiling stainless steel shower head with antilimestone system 70x40 cm, with 2 functions: 2 rain jet workstations and a central waterfall jet.

**A579RSF7040NC**

Soffione a soffitto in Acciaio INOX lucidato a specchio con sistema anti-calcare, 70x40 cm, a 2 funzioni: 2 postazioni pioggia, nebulizzazione (4 uscite), ed un getto a cascata centrale.
Ceiling stainless steel shower head with antilimestone system 70x40 cm, with 3 functions: 2 rain jet workstation, nebulization (4 outlets) and a central waterfall jet.

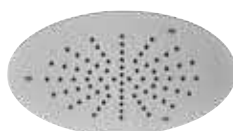
**A578SFCM30**

Soffione a soffitto in Acciaio INOX lucidato a specchio con sistema anti-calcare Ø30 cm, con getto a pioggia.
Ceiling stainless steel mirror polished shower head with antilimestone system Ø30 cm, with rain jet.

**A578SFCM40**

Soffione a soffitto in Acciaio INOX lucidato a specchio con sistema anti-calcare Ø40 cm, con getto a pioggia.
Ceiling stainless steel mirror polished shower head with antilimestone system Ø40 cm, with rain jet.

**A578SFCM55**

Soffione a soffitto in Acciaio INOX lucidato a specchio con sistema anti-calcare Ø55 cm, con getto a pioggia.
Ceiling stainless steel mirror polished shower head with antilimestone system Ø55 cm, with rain jet.

**A578SFCM42N**

Soffione a soffitto in Acciaio INOX lucidato a specchio con sistema anti-calcare Ø42 cm, a 2 funzioni: pioggia e nebulizzazione (4 uscite).
Ceiling stainless steel mirror polished shower head with antilimestone system Ø42 cm, with 2 functions: rain jet and nebulization (4 outlets).

**A578SFCM55N**

Soffione a soffitto in Acciaio INOX lucidato a specchio con sistema anti-calcare Ø55 cm, a 2 funzioni: pioggia e nebulizzazione (6 uscite).
Ceiling stainless steel mirror polished shower head with antilimestone system Ø55 cm, with 2 functions: rain jet and nebulization (6 outlets).

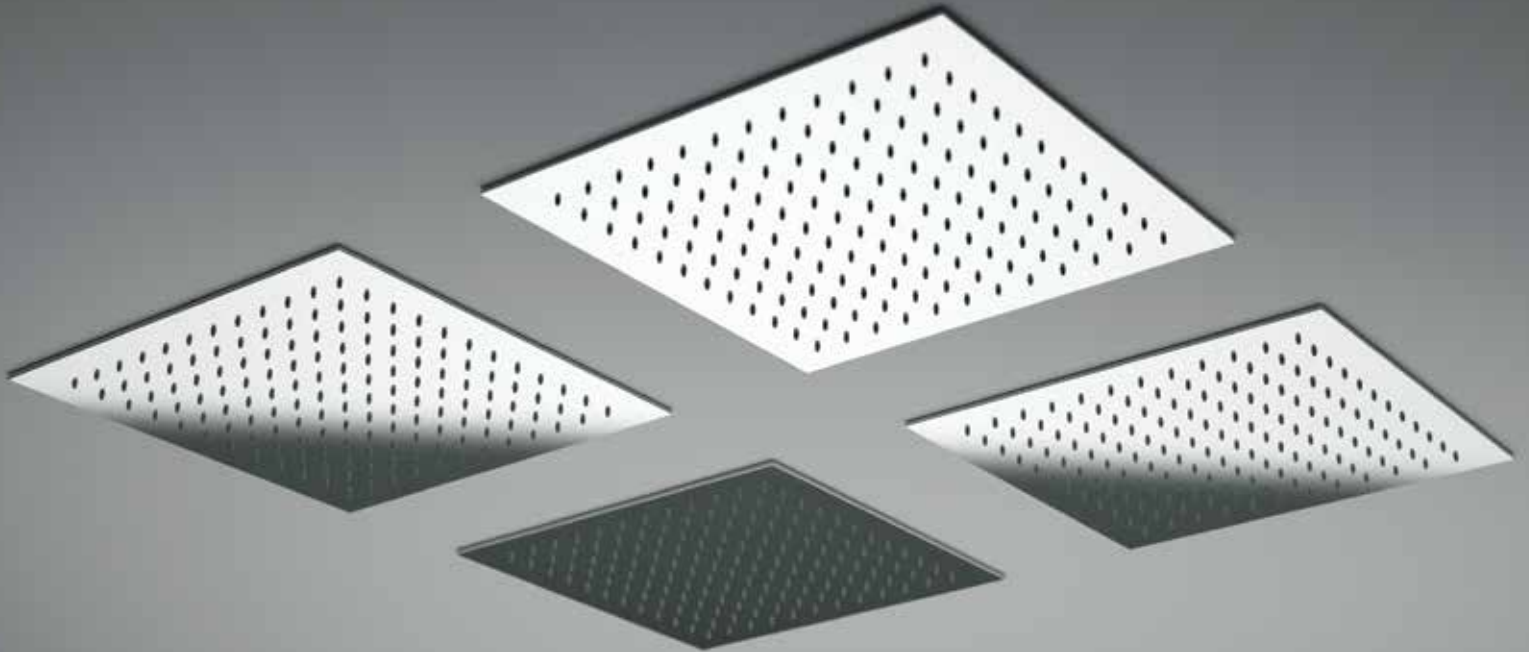

A578EFCM34

Soffione doccia EASY FIX in acciaio INOX lucidato a specchio Ø34 cm.
EASY FIX stainless steel mirror polished shower head Ø34 cm.



A578EFCM44

Soffione doccia EASY FIX in acciaio INOX lucidato a specchio Ø44 cm.
EASY FIX stainless steel mirror polished shower head Ø44 cm.

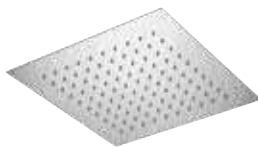

A579EFCM34

Soffione doccia EASY FIX in acciaio INOX lucidato a specchio 34x34 cm.
EASY FIX stainless steel mirror polished shower head 34x34 cm.



A579EFCM44

Soffione doccia EASY FIX in acciaio INOX lucidato a specchio 44x44 cm.
EASY FIX stainless steel mirror polished shower head 44x44 cm.

APPLICAZIONE A SOFFITTO "EASY FIX" - "EASY FIX" CEILING APPLICATION

Per questa tipologia di soffione e con questo specifico sistema di fissaggio sono previste quattro molle per ogni soffione.

For this specic shower-head with this specific mounting system, four springs are installed on each head.

1

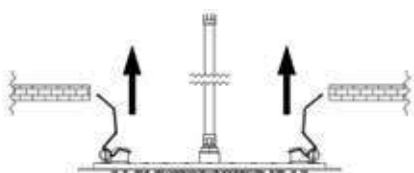

Nell'immagine 1 si evidenzia il primo movimento necessario: caricare due molle vicine tra loro mettendole quasi in posizione verticale rispetto al soffione ed inserirle all'interno del foro precedentemente preparato. Rilasciare le stesse delicatamente.

In picture 1, you shall see the first needed movement to activate them: Spring-load two springs next to each other placing them almost vertically and insert them in the hole in the ceiling; Release them gently;

2

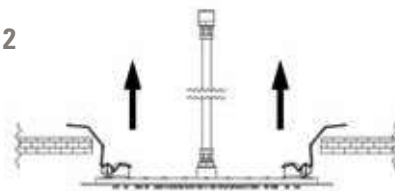

Mantenendo il soffione leggermente inclinato procedere caricando ed inserendo le rimanenti due molle come da immagine 2.

While keeping the showerhead slightly inclined, proceed by spring-loading and inserting the two other springs as shown in picture 2.

3

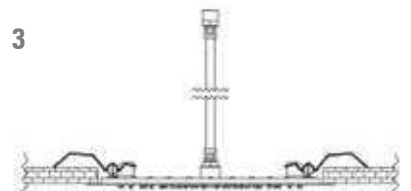

A questo punto rilasciare delicatamente le molle alla loro naturale tensione e, trattenendo esternamente il soffione, accompagnare lo stesso verso il totale appoggio al soffitto come da immagine 3.

Now release the springs back to their natural tension and, while holding the head from outside, guide it to its final position as shown in picture 3.

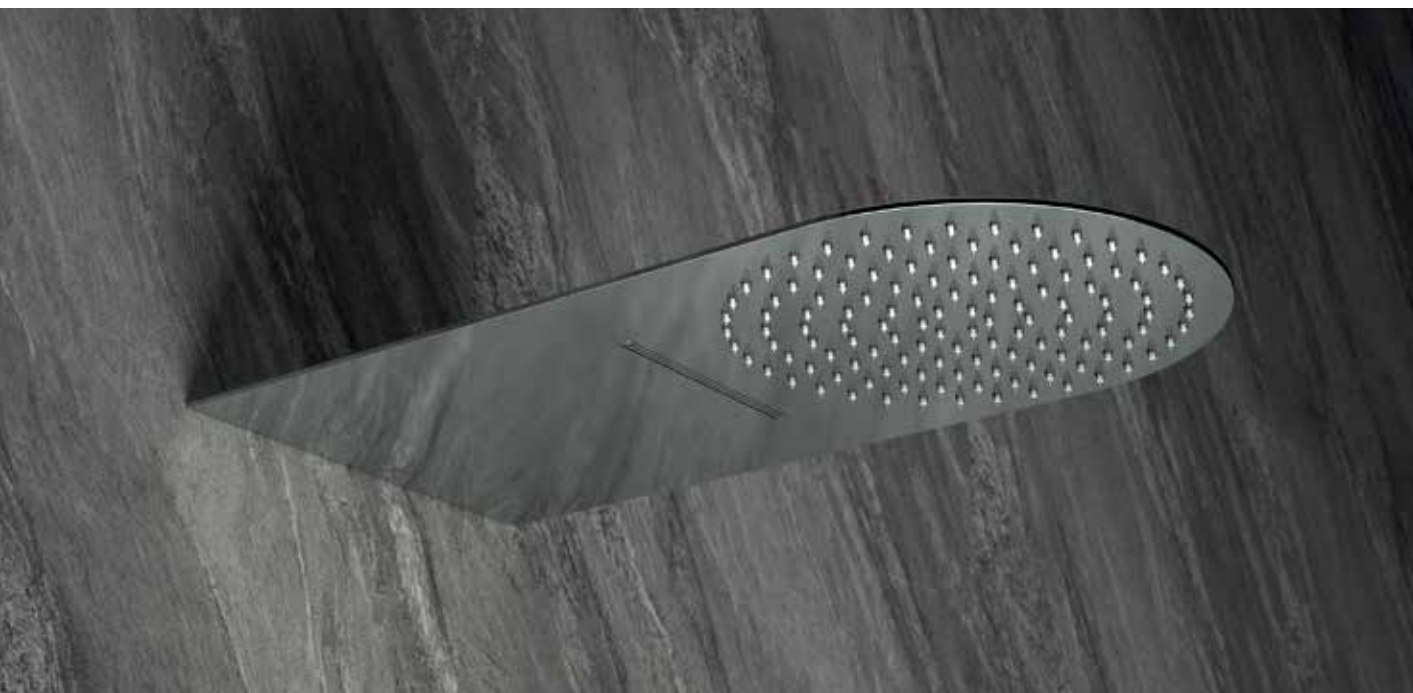

BOX
INCASSO
BUILT-IN
BOX

WELLNESS
KIT

CROMOTERAPIA
COLOUR
THERAPIE

SOFFIONI
SHOWER
HEAD

PANNELLI
DOCCIA
SHOWER
PANELS

COLONNE
DOCCIA
SHOWER
COLUMN

SALISCENDI
SLIDING
RAILS

DOCCETTE
HAND
SHOWERS

OASIS
SHUT-OFF

BOCCHE
SPOUTS

ACCESSORI
RUBINETTERIA
TAP
ACCESSORIES



A578 CM20

Soffione doccia ultra piatto Ø20 cm in acciaio INOX lucidato a specchio. *Ultra slim stainless steel mirror polished shower head Ø20 cm.*



A578 CM25

Soffione doccia ultra piatto Ø25 cm in acciaio INOX lucidato a specchio. *Ultra slim stainless steel mirror polished shower head Ø25 cm.*



A578 CM30

Soffione doccia ultra piatto Ø30 cm in acciaio INOX lucidato a specchio. *Ultra slim stainless steel mirror polished shower head Ø30 cm.*



A578 CM40

Soffione doccia ultra piatto Ø40 cm in acciaio INOX lucidato a specchio. *Ultra slim stainless steel mirror polished shower head Ø40 cm.*



A564

Soffione doccia ultrapiatto 50x25 cm, a parete in acciaio INOX lucidato a specchio. *Ultra slim stainless steel mirror polished wall shower head 50x25 cm.*



A564CA

Soffione doccia ultrapiatto 50x25 cm, a parete in acciaio INOX lucidato a specchio, 2 funzioni: a pioggia e cascata. *Ultra slim stainless steel mirror polished wall shower head, 2 functions: rain jet and waterfall, 50x25 cm.*



A566

Soffione doccia a parete 50x20 cm, in acciaio INOX lucidato a specchio. *Stainless steel mirror polished wall shower head 50x20 cm.*



A566CA

Soffione doccia a parete 50x20 cm, in acciaio INOX lucidato a specchio, 2 funzioni: a pioggia e cascata. *Stainless steel mirror polished wall shower head, 2 functions: rain jet and waterfall, 50x20 cm.*



A579 CM20

Soffione doccia ultra piatto 20x20 cm in acciaio INOX lucidato a specchio.
Ultra slim stainless steel mirror polished shower head 20x20 cm.



A579 CM25

Soffione doccia ultra piatto 25x25 cm in acciaio INOX lucidato a specchio.
Ultra slim stainless steel mirror polished shower head 25x25 cm.



A579 CM30

Soffione doccia ultra piatto 30x30 cm in acciaio INOX lucidato a specchio.
Ultra slim stainless steel mirror polished shower head 30x30 cm.



A579 CM40

Soffione doccia ultra piatto 40x40 cm in acciaio INOX lucidato a specchio.
Ultra slim stainless steel mirror polished shower head 40x40 cm.



A563

Soffione doccia ultrapiatto 5mm, 50x25 cm, a parete in acciaio INOX lucidato a specchio.
Ultra slim stainless steel mirror polished wall shower head 50x25 cm.



A563CA

Soffione doccia ultrapiatto 5mm, 50x25 cm, a parete in acciaio INOX lucidato a specchio, a 2 funzioni: getto a pioggia e cascata.
5 mm ultra slim stainless steel mirror polished wall showerhead, 2 functions: rain jet and waterfall, 50x25 cm.



A562

Soffione doccia a parete 50x20 cm, in acciaio INOX lucidato a specchio.
Stainless steel mirror polished wall shower head 50x20 cm.



A562CA

Soffione doccia a parete 50x20cm, in acciaio INOX lucidato a specchio, 2 getti, normale o cascata.
Stainless steel mirror polished wall shower head, 2 jets, normal and waterfall 50x20 cm.



A579R

Soffione doccia ultra piatto 33x22 cm in acciaio INOX lucidato a specchio.
Ultra slim stainless steel mirror polished shower head 33x22 cm.

LINEA QUADRATA CON ANGOLI ARROTONDATI IN ACCIAIO INOX
STAINLESS STEEL SQUARED LINE WITH ROUND CORNERS

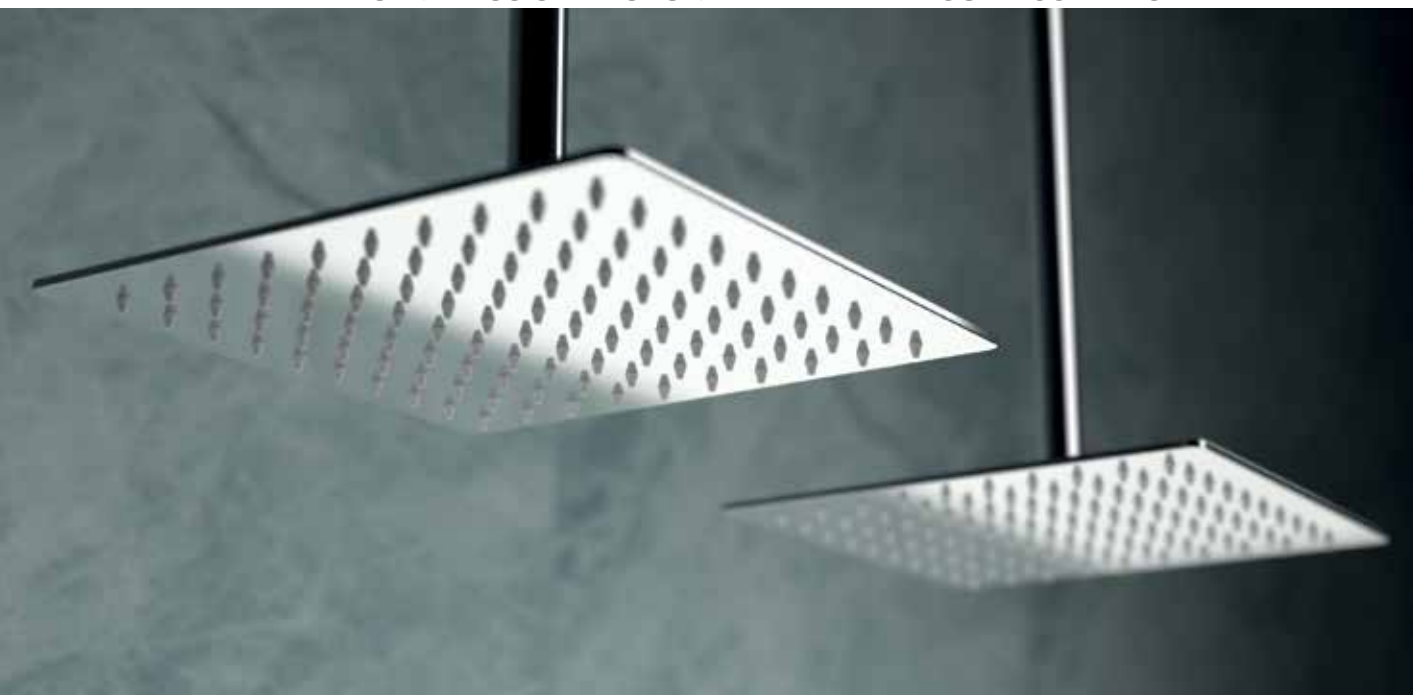

A577 CM20

Soffione doccia quadrato con angoli arrotondati ultrapiatto in Acciaio Inox 20x20 cm lucidato a specchio, con getti in silicone anticalcare.
Squared with rounded corners ultra slim stainless steel mirror polished shower head 20x20 cm, with anti-limestone silicon jets.



A577 CM25

Soffione doccia quadrato con angoli arrotondati ultrapiatto in Acciaio Inox 25x25 cm lucidato a specchio, con getti in silicone anticalcare.
Squared with rounded corners ultra slim stainless steel mirror polished shower head 25x25 cm, with anti-limestone silicon jets.



A577 CM30

Soffione doccia quadrato con angoli arrotondati ultrapiatto in Acciaio Inox 30x30 cm lucidato a specchio, con getti in silicone anticalcare.
Squared with rounded corners ultra slim stainless steel mirror polished shower head 30x30 cm, with anti-limestone silicon jets.



A577 CM40

Soffione doccia quadrato con angoli arrotondati ultrapiatto in Acciaio Inox 40x40 cm lucidato a specchio, con getti in silicone anticalcare.
Squared with rounded corners ultra slim stainless steel mirror polished shower head 40x40 cm, with anti-limestone silicon jets.



A565

Soffione doccia ultrapiatto 5mm, 50x25 cm, a parete in acciaio INOX lucidato a specchio.
Ultra slim stainless steel mirror polished wall shower head 50x25 cm.



A565CA

Soffione doccia ultrapiatto 5mm, 50x25 cm, a parete in acciaio INOX lucidato a specchio, a 2 funzioni: getto a pioggia e cascata.
5 mm ultra slim stainless steel mirror polished wall showerhead, 2 functions: rain jet and waterfall, 50x25 cm.



WELLNESS

BOX
INCASSO
BUILT-IN
BOX

WELLNESS
KIT

CROMOTERAPIA
COLOUR
THERAPIE

SOFFIONI
SHOWER
HEAD

PANNELLI
DOCCIA
SHOWER
PANELS

COLONNE
DOCCIA
SHOWER
COLUMN

SLISCENDI
SLIDING
RAILS

DOCCETTE
HAND
SHOWERS

OASIS
SHUT-OFF

BOCCHE
SPOUTS

ACCESSORI
RUBINETTERIA
TAP
ACCESSORIES

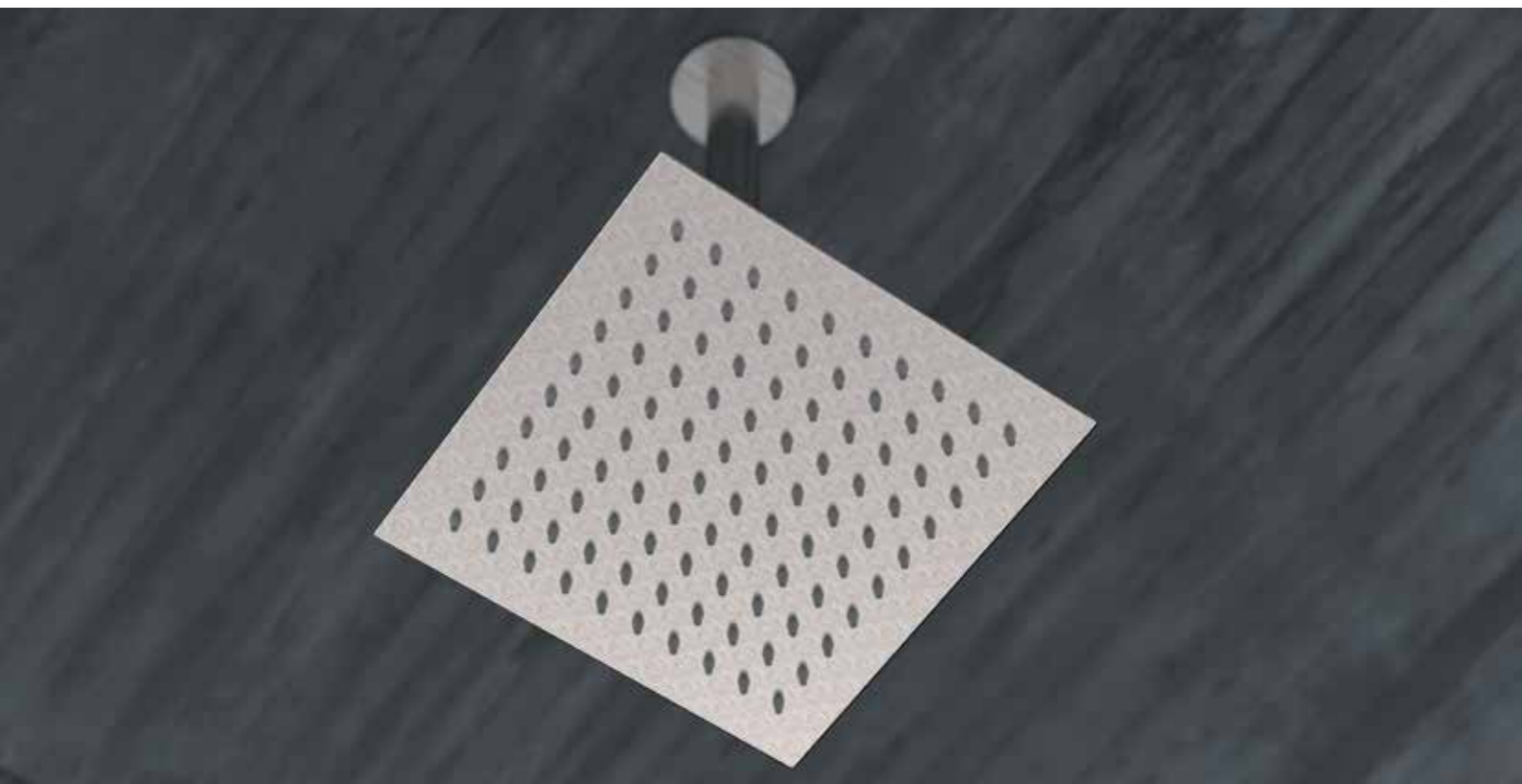

STAINLESS
STEEL

SSA579 CM20

Soffione doccia ultra piatto 20x20 cm
in acciaio INOX spazzolato.
*Ultra slim brushed stainless steel
shower head 20x20 cm.*



STAINLESS
STEEL

SSA579 CM25

Soffione doccia ultra piatto 25x25 cm
in acciaio INOX spazzolato.
*Ultra slim brushed stainless steel
shower head 25x25 cm.*



STAINLESS
STEEL

SSA579 CM30

Soffione doccia ultra piatto 30x30 cm
in acciaio INOX spazzolato.
*Ultra slim brushed stainless steel
shower head 30x30 cm.*



STAINLESS
STEEL

SSA579 CM40

Soffione doccia ultra piatto 40x40 cm
in acciaio INOX spazzolato.
*Ultra slim brushed stainless steel
shower head 40x40 cm.*

STAINLESS
STEEL**SSA578 CM20**

Soffione doccia ultra piatto Ø20 cm in acciaio INOX spazzolato.
Ultra slim brushed stainless steel shower head Ø20 cm.

STAINLESS
STEEL**SSA578 CM25**

Soffione doccia ultra piatto Ø25 cm in acciaio INOX spazzolato.
Ultra slim brushed stainless steel shower head Ø25 cm.

STAINLESS
STEEL**SSA578 CM30**

Soffione doccia ultra piatto Ø30 cm in acciaio INOX spazzolato.
Ultra slim brushed stainless steel shower head Ø30 cm.

STAINLESS
STEEL**SSA578 CM40**

Soffione doccia ultra piatto Ø40 cm in acciaio INOX spazzolato.
Ultra slim brushed stainless steel shower head Ø40 cm.

STAINLESS
STEEL**SSSJETX**

Getto rotondo Ø5 cm, in acciaio INOX spazzolato per sistema doccia, anticalcare, con snodo.
Round body jet Ø5 cm, in brushed stainless steel for shower systems, antilimestone, with ball-joint.

STAINLESS
STEEL**SSOXJETX**

Getto quadrato 5x5 cm, in acciaio INOX spazzolato per sistema doccia, anticalcare, con snodo.
Squared body jet 5x5 cm, in brushed stainless steel for shower systems, antilimestone, with ball-joint.

STAINLESS
STEEL**SSA566CA**

Soffione doccia a parete 50x20 cm, in acciaio INOX lucidato a specchio, 2 funzioni: a pioggia e cascata.
Stainless steel mirror polished wall shower head, 2 functions: rain jet and waterfall, 50x20 cm.

**SSA557**

Braccio doccia tondo da soffitto, in acciaio INOX spazzolato. cm: 10, 20, 30.
Ceiling round shower arm, in brushed stainless steel. cm: 10, 20, 30.

STAINLESS
STEELSTAINLESS
STEEL**SSA555L**

Braccio doccia tondo da parete, in acciaio INOX spazzolato, cm 30.
Wall round shower arm, in brushed stainless steel, cm 30.

BOX
INCASSO
BUILT-IN
BOXWELLNESS
KITCROMOTERAPIA
COLOUR
THERAPIESOFFIONI
SHOWER
HEADPANNELLI
DOCCIA
SHOWER
PANELSCOLONNE
DOCCIA
SHOWER
COLUMNSALISCENDI
SLIDING
RAILSDOCCETTE
HAND
SHOWERSOASIS
SHUT-OFFBOCCHIE
SPOUTSACCESSORI
RUBINETTERIA
TAP
ACCESSORIES

SOFFIONI - SHOWER HEADS

SOFFIONI A PARETE MINIMALI IN ACCIAIO INOX STAINLESS STEEL MINIMAL WALL SHOWER HEAD



A559XN

Soffione doccia Ø 15,4 cm, lunghezza 29,17 cm, a parete in acciaio INOX lucidato a specchio.
Stainless steel mirror polished wall shower head Ø15,4 cm, length 29,17 cm.



A559XS

Soffione doccia 15,5x15,5 cm, lunghezza 25,05 cm, a parete in acciaio INOX lucidato a specchio.
Stainless steel mirror polished wall shower head 15,5x15,5 cm, length 25,05 cm.

SOFFIONI CUBO A SOFFITTO IN ACCIAIO INOX
STAINLESS STEEL CEILING CUBE SHOWER HEAD

WELLNESS



BOX
INCASSO
BUILT-IN
BOX

WELLNESS
KIT

CROMOTERAPIA
COLOUR
THERAPIE

SOFFIONI
SHOWER
HEAD

PANNELLI
DOCCIA
SHOWER
PANELS

COLONNE
DOCCIA
SHOWER
COLUMN

SAISCENDI
SLIDING
RAILS

DOCCETTE
HAND
SHOWERS

OASIS
SHUT-OFF

BOCCHE
SPOUTS

ACCESSORI
RUBINETTERIA
TAP
ACCESSORIES



A579BX25

Soffione doccia 25,5x25,5 cm, Altezza 18,15 cm, a soffitto in acciaio INOX lucidato a specchio. 1 getto pioggia.
Stainless steel mirror polished ceiling shower head 25,5x25,5 cm, height 18,15 cm. 1 rain jet.

A579BX252C

Soffione doccia 25,5x25,5 cm, Altezza 18,15 cm, a soffitto in acciaio INOX lucidato a specchio. 2 getti: getto pioggia e 2 postazioni cascata.
Stainless steel mirror polished ceiling shower head 25,5x25,5 cm, height 18,15 cm. 2 jets: rain jet and 2 waterfall jets.



A590CA
Soffione doccia con getto a cascata,
serie Skyline.
*C.p. Brass shower head with waterfall
jet, Skyline serie.*



A594DC
Soffione doccia con getto a cascata,
serie Diva.
*C.p. Brass shower head with waterfall
jet, Diva serie.*



A594SC
Soffione doccia con getto a cascata,
serie Suvi.
*C.p. Brass shower head with waterfall
jet, Suvi serie.*



A590XL
Soffione/bocca a cascata ad L in
acciaio INOX lucidato a specchio.
*Stainless steel mirror polished "L"
waterfall shower head/spout.*



A590XS
Soffione/bocca a cascata ad incasso
squadrata in acciaio INOX lucidato a
specchio.
*Squared built-in stainless steel mirror
polished waterfall shower head/spout.*



A594XM
Soffione/bocca a cascata ad incasso
con angoli arrotondati in acciaio INOX
lucidato a specchio.
*Built-in stainless steel mirror polished
waterfall shower head/spout with
round corners.*

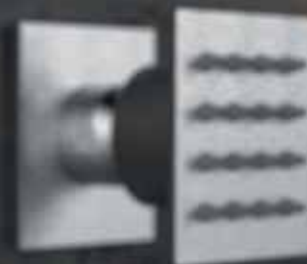
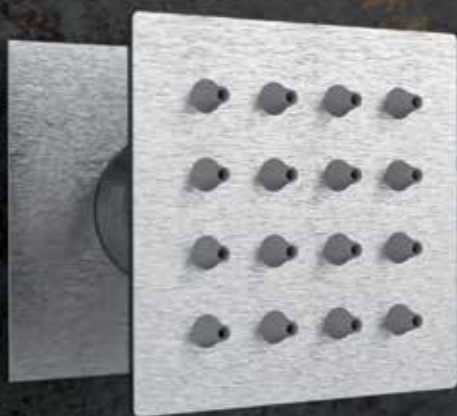

BOX
INCASSO
BUILT-IN
BOX

WELLNESS
KIT

CROMOTERAPIA
COLOUR
THERAPIE

SOFFIONI
SHOWER
HEAD

PANNELLI
DOCCIA
SHOWER
PANELS

COLONNE
DOCCIA
SHOWER
COLUMN

SALISCENDI
SLIDING
RAILS

DOCCETTE
HAND
SHOWERS

OASIS
SHUT-OFF

BOCCH
SPOUTS

ACCESSORI
RUBINETTERIA
TAP
ACCESSORIES



SSOXJETX

Body jet quadrato 5x5 cm, in acciaio INOX spazzolato per sistema doccia, anticalcare, con snodo.
Squared body jet 5x5 cm, in brushed stainless steel for shower systems, antilimestone, with ball-joint.



SSSJETX

Body jet rotondo Ø5 cm, in acciaio INOX spazzolato per sistema doccia, anticalcare, con snodo.
Round body jet Ø5 cm, in brushed stainless steel for shower systems, antilimestone, with ball-joint.



OXJET

Body jet quadrato 4,2x4,2x3,9 cm, in ottone cromato e getti anticalcare.
Squared body jet 4,2x4,2x3,9 cm, in c.p. brass with anti-limestone jets.



SJET

Body jet quadrato Ø4x3,9 cm, in ottone cromato e getti anticalcare.
Squared body jet Ø4x3,9 cm, in c.p. brass with anti-limestone jets.



QXJETX

Body jet quadrato 5x5 cm, in acciaio INOX lucidato a specchio per sistema doccia, anticalcare, con snodo.
Squared body jet 5x5 cm, in stainless steel mirror polished for shower systems, antilimestone, with ball-joint.



SJETX

Body jet rotondo Ø5 cm, in acciaio INOX lucidato a specchio per sistema doccia, anticalcare, con snodo.
Round body jet Ø5 cm, in stainless steel mirror polished for shower systems, antilimestone, with ball-joint.



QXJETXB

Body jet da incasso quadrato 5x5 cm, in acciaio INOX lucidato a specchio per sistema doccia, anticalcare.
Built-in squared body jet 5x5 cm, in stainless steel mirror polished for shower systems, antilimestone.



SJETXB

Body jet da incasso rotondo Ø5 cm, in acciaio INOX lucidato a specchio per sistema doccia, anticalcare.
Built-in round body jet Ø5 cm, in stainless steel mirror polished for shower systems, antilimestone.

LINEA TONDA TUTTO IN OTTONE - ALL IN BRASS ROUND LINE



A594

Soffione a pioggia, cromato, con getti in silicone anticalcare, a snodo, completamente in ottone Ø20 cm.
Shower Head, all c.p. brass, with jets in silicone anti-limestone, with ball-joint, cm Ø20 cm.



A594 CM30

Soffione a pioggia, cromato, con getti in silicone anticalcare, a snodo, completamente in ottone Ø30 cm.
Shower Head, all c.p. brass, with jets in silicone anti-limestone, with ball-joint, cm Ø30 cm.



A595

Soffione a pioggia piatto, a snodo, Ø35 cm, cromato, con 216 getti in silicone anticalcare, completamente in ottone.
Minimal shower head, all in c.p. brass, Ø35 cm, with 216 jets in silicone anti-limestone, with ball-joint.



A582

Soffione a pioggia 60 getti tutto in ottone cromato, autopulente, anticalcare, a snodo Ø 15 cm.
Showerhead 60 jets in CP brass, anti-limestone, self-cleaning, with ball-joint Ø 15 cm.



A587

Soffione a pioggia 30 getti, tutto in ottone cromato, a snodo.
Showerhead 30 jets in CP brass with ball-joint.



A589

Soffione a pioggia Ø 20 cm, tutto in ottone cromato, con funzione raccoglimento acqua, usati anche in situazione di bassa pressione.
Shower head Ø 20 cm, all in CP brass, used also for low pressure situations.



A586 CM18

Soffione a pioggia Ø18 cm tutto in ottone cromato e snodo (78 getti).
Showerhead Ø18 cm all in CP brass with ball-joint (78 jets).



A586 CM25

Soffione a pioggia Ø25 cm tutto in ottone cromato e snodo (144 getti).
Showerhead Ø25 cm all in CP brass with ball-joint (144 jets).

LINEA QUADRATA TUTTO IN OTTONE - ALL IN BRASS SQUARED LINE



A590

Soffione completamente in ottone cromato, con 144 getti in silicone soffice autopulente anticalcare, cm 20x20.
Showerhead completely in c.p. brass, with 144 jets in soft silicon, selfcleaning and anti-limestone, cm 20x20.



A592

Soffione a pioggia rettangolare, a snodo, 24x14, cromo, con 128 getti in silicone anticalcare, completamente in ottone.
Rectangular shower head, all in c.p. brass, 24x14, with 128 jets in silicone anti-limestone, with ball-joint.



A593B

Soffione a pioggia quadrato piatto, a snodo, 30x30, cromo, con 144 getti in silicone anticalcare, completamente in ottone.
Squared shower head, all in c.p. brass, 30x30, with 144 jets in silicone anti-limestone, with ball-joint.



A593

Soffione a pioggia quadrato piatto, a snodo, 35x35, cromo, con 225 getti in silicone anticalcare, completamente in ottone.
Squared shower head, all in c.p. brass, 35x35, with 225 jets in silicone anti-limestone, with ball-joint.

SOFFIONI IN ABS - ABS SHOWER HEAD

**A584CM20**

Soffione doccia minimale Ø20 cm, in ABS lusso, cromato, con getti in silicone autopulenti e anticalcare.
Chrome plated minimal deluxe ABS shower head, Ø20 cm, with silicon selfcleaning antilimestone jets.

**A588SDCM20**

Soffione doccia quadrato 20x20 cm, in ABS lusso, cromato, con getti in silicone autopulenti e anticalcare.
Chrome plated square deluxe ABS shower head, 20x20 cm, with silicon selfcleaning antilimestone jets.

**A584CM25**

Soffione doccia minimale Ø25 cm, in ABS lusso, cromato, con getti in silicone autopulenti e anticalcare.
Chrome plated minimal deluxe ABS shower head, Ø25 cm, with silicon selfcleaning antilimestone jets.

**A588SDCM25**

Soffione doccia quadrato 25x25 cm, in ABS lusso, cromato, con getti in silicone autopulenti e anticalcare.
Chrome plated square deluxe ABS shower head, 25x25 cm, with silicon selfcleaning antilimestone jets.

**A584CM30**

Soffione doccia minimale Ø25 cm, in ABS lusso, cromato, con getti in silicone autopulenti e anticalcare.
Chrome plated minimal deluxe ABS shower head, Ø25 cm, with silicon selfcleaning antilimestone jets.

**A588SDCM30**

Soffione doccia quadrato 30x30 cm, in ABS lusso, cromato, con getti in silicone autopulenti e anticalcare.
Chrome plated square deluxe ABS shower head, 30x30 cm, with silicon selfcleaning antilimestone jets.

**A585EC20**

Soffione a pioggia minimale, in ABS cromato, Ø 20 cm, con getti in silicone anticalcare.
C.p. ABS shower head, rain jet, Ø 20 cm, with anti-limestone silicon jets.

**A581**

Soffione doccia quadrato con angoli arrotondati, ultrapiatto, cm 20x20, in ABS cromato, con getti in silicone autopulenti e anticalcare.
Chrome plated ABS showerhead, squared with rounded edges, ultrathin, cm 20x20, with silicon selfcleaning antilimestone jets.

**A584V3**

Soffione a 3 funzioni con tasto centrale per il cambio dei getti: getto pioggia, nebulizzazione e misto, in ABS cromato, Ø 23 cm, con getti in silicone anticalcare.
C.p. ABS shower head, 3 functions with central button to change jets: rain, nebulization and mixed, Ø 23 cm, with anti-limestone silicon jets.

**A584 AD20**

Soffione a pioggia squadro con angoli arrotondati, in ABS cromato, 20x20 cm, con getti in silicone anticalcare.
C.p. ABS squared with rounded corners shower head, rain jet, 20x20 cm, with anti-limestone silicon jets.

BOX
INCASSO
BUILT-IN
BOXWELLNESS
KITCROMOTERAPIA
COLOUR
THERAPIESOFFIONI
SHOWER
HEADPANNELLI
DOCCIA
SHOWER
PANELSCOLONNE
DOCCIA
SHOWER
COLUMNSALISCENDI
SLIDING RAILSDOCCETTE
HAND
SHOWERSOASIS
SHUT-OFFBOCCHE
SPOUTSACCESSORI
RUBINETTERIA
TAP
ACCESSORIES

SOFFIONI - SHOWER HEADS



A588

Soffione a pioggia ultrapiatto, cromo-satinato, getti in silicone anticalcare, a snodo, Ø 24 cm.
Shower-head extraflat line, chrome-satin, with anti-limestone silicon jets, with ball-joint, Ø 24 cm.



A588S

Soffione a pioggia "Square", in ABS cromo-satinato, getti in silicone anticalcare, a snodo, cm 23 x 23.
Shower-head "Square", ABS chrome-satin, with anti-limestone silicon jets, with ball-joint, cm 23 x 23.



A576

Soffione a pioggia Ø16 cm con getti anticalcare e snodo.
Shower head Ø16 cm with anti-limestone jets and ball-joint.



A585

Soffione a pioggia Ø24 cm con getti anticalcare e snodo.
Shower head Ø24 cm with anti-limestone jets and ball-joint.



A580 CR15

Soffione a pioggia Ø15 cm con getti anticalcare e snodo.
Showerhead Ø15 cm, with anti-limestone jet and ball joint.



A580 CR23

Soffione a pioggia Ø23 cm con getti anticalcare e snodo.
Showerhead Ø23 cm, with anti-limestone jet and ball joint.



A559

Braccio doccia con soffione integrato a disco, anticalcare.
Shower arm and head together in chrome with anti-limestone disc.



A559B

Braccio doccia con soffione integrato a disco, anticalcare a 2 funzioni.
Shower arm and head together in chrome with anti-limestone disc, 2 functions.



A575

Soffione cromato e satinato con disco anticalcare a snodo con 4 funzioni.
Showerhead in chrome and satin, 4 functions anti-limestone jet, with ball joint.



A560

Soffione con disco anticalcare a snodo.
Showerhead with anti-limestone disc with ball joint.



A570

Soffione a snodo anticalcare 2 funzioni cromato.
Cp Showerhead anti-limestone 2 functions with ball-joint.

BRACCI DOCCIA - SHOWER ARMS

**A557Q**

Braccio doccia quadrato da soffitto, completamente in ottone cromato.
cm: 10, 20, 30, 40, 50.
Ceiling square shower arm, completely in chrome plated brass.
cm: 10, 20, 30, 40, 50.

**A557**

Braccio doccia tondo da soffitto, completamente in ottone cromato.
cm: 10, 20, 30, 40, 50.
Ceiling round shower arm, completely in chrome plated brass.
cm: 10, 20, 30, 40, 50.

**A552**

Braccio doccia Minimale in ottone cromato con rosetta 1/2Mx1/2M.
cm: 20, 30, 40, 50.
CP brass shower arm Minimal, with wall flange 1/2Mx1/2M
cm: 20, 30, 40, 50.

**A553Q**

Braccio doccia quadrato, completo di rosetta quadrata 1/2Mx1/2M, completamente in ottone cromato.
cm: 30, 40.
Squared shower arm, complete with square wall flange 1/2Mx1/2M, all in c.p. brass.
cm: 30, 40.

**A552D**

Braccio doccia Minimal in ottone cromato con rosetta e con deviatore integrato e doppia uscita 1/2 per attacco sia del soffione che del flessibile doccia. 1/2MX1/2MX1/2M.
cm: 20, 30, 40, 50.
Shower arm Minimal in c.p. chrome with flange, with integrated diverter with double output 1/2" to connect both the showerhead and the shower flexible. 1/2MX1/2MX1/2M.
cm: 20, 30, 40, 50.

**A553**

Braccio doccia in ottone cromato con rosetta. cm: 20, 30.
CP brass shower arm, with wall flange. cm: 20, 30.

**A555**

Braccio doccia in ottone cromato con rosetta 1/2Mx1/2M.
cm: 20, 30, 40.
C.P. brass tube shower arm, with wall flange 1/2Mx1/2M.
cm: 20, 30, 40.

**A555L**

Braccio doccia in ottone cromato con rosetta, 1/2Mx1/2M.
cm: 30, 40.
C.P. brass tube shower arm, with wall flange, 1/2Mx1/2M.
cm: 30, 40.

**A551**

Braccio doccia in ottone cromato con rosetta 1/2Mx1/2M lunghezza cm 30.
CP brass shower arm, with wall flange 1/2Mx1/2M length cm 30.

**A558**

Braccio doccia in ottone cromato, con rosetta, 1/2M x 1/2M.
C.P. Brass tube shower arm, with wall flange, 1/2M x 1/2M.

**A550**

Braccio doccia conico, in ottone cromato.
C.P. brass casted shower arm 1/2.

**A554**

Braccio doccia lusso cm 20, in ottone cromato.
"Deluxe" shower arm, leght cm 20, in c.p. brass.

BOX
INCASSO
BUILT-IN
BOXWELLNESS
KITCROMOTERAPIA
COLOUR
THERAPIESOFFIONI
SHOWER
HEADPANNELLI
DOCCIA
SHOWER
PANELSCOLONNE
DOCCIA
SHOWER
COLUMNSALISCENDI
SLIDING
RAILSDOCCETTE
HAND
SHOWERSOASIS
SHUT-OFFBOCCHE
SPOUTSACCESSORI
RUBINETTERIA
TAP
ACCESSORIES



PANNELLI DOCCIA SHOWER PANELS



WELLNESS

BOX
INCASSO
BUILT-IN
BOX

WELLNESS
KIT

CROMOTERAPIA
COLOUR
THERAPIE

SOFFIONI
SHOWER
HEAD

PANNELLI
DOCCIA
SHOWER
PANELS



COLONNE
DOCCIA
SHOWER
COLUMN

SALISCENDI
SLIDING
RAILS

DOCCETTE
HAND
SHOWERS

OASIS
SHUT-OFF

BOCCE
SPOUTS

ACCESSORI
RUBINETTERIA
TAP
ACCESSORIES

PANNELLI DOCCIA - SHOWER PANELS



PANNELLI DOCCIA - SHOWER PANELS

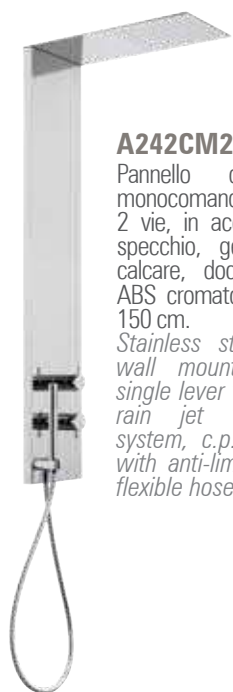

A242CM20

Pannello doccia a parete, monocomando con deviatore a 2 vie, in acciaio INOX lucidato a specchio, getto a pioggia anti-calcare, doccetta anti-calcare in ABS cromato, flessibile in PVC da 150 cm.

Stainless steel mirror polished wall mounted shower panel, single lever with 2 ways diverter, rain jet with anti-limestone system, c.p. ABS hand shower with anti-limestone system, PVC flexible hose 150 cm.



A242CM20J

Pannello doccia a parete, monocomando con deviatore a 3 vie, in acciaio INOX lucidato a specchio, getto a pioggia anti-calcare, body jets anti-calcare, doccetta anti-calcare in ABS cromato, flessibile in PVC da 150 cm.

Stainless steel mirror polished wall mounted shower panel, single lever with 3 ways diverter, rain jet with anti-limestone system, anti-limestone body jets, c.p. ABS hand shower with anti-limestone system, PVC flexible hose 150 cm.



A242CM20JC

Pannello doccia a parete, monocomando con deviatore a 4 vie, in acciaio INOX lucidato a specchio, getto a pioggia anti-calcare e getto a cascata, body jets anti-calcare, doccetta anti-calcare in ABS cromato, flessibile in PVC da 150 cm.

Stainless steel mirror polished wall mounted shower panel, single lever with 4 ways diverter, rain jet with anti-limestone system, waterfall jet, anti-limestone body jets, c.p. ABS hand shower with anti-limestone system, PVC flexible hose 150 cm.

PANNELLI DOCCIA TERMOSTATICI - THERMOSTATIC SHOWER PANELS

**A242TCM20**

Pannello doccia a parete termostatico coassiale, monocomando con deviatore a 2 vie, in acciaio INOX lucidato a specchio, getto a pioggia anti-calcare, doccetta anti-calcare in ABS cromato, flessibile in PVC da 150 cm.

Stainless steel mirror polished wall mounted thermostatic coaxial shower panel, single lever with 2 ways diverter, rain jet with anti-limestone system, c.p. ABS hand shower with anti-limestone system, PVC flexible hose 150 cm.

**A242TCM20J**

Pannello doccia a parete termostatico, monocomando con deviatore a 3 vie, in acciaio INOX lucidato a specchio, getto a pioggia anti-calcare, body jets anti-calcare, doccetta anti-calcare in ABS cromato, flessibile in PVC da 150 cm.

Stainless steel mirror polished wall mounted thermostatic shower panel, single lever with 3 ways diverter, rain jet with anti-limestone system, anti-limestone system body jets, c.p. ABS hand shower with anti-limestone system, PVC flexible hose 150 cm.

**A242TCM20JC**

Pannello doccia a parete termostatico, monocomando con deviatore a 4 vie, in acciaio INOX lucidato a specchio, getto a pioggia anti-calcare e getto a cascata, body jets anti-calcare, doccetta anti-calcare in ABS cromato, flessibile in PVC da 150 cm.

Stainless steel mirror polished wall mounted thermostatic shower panel, single lever with 4 ways diverter, rain jet with anti-limestone system, waterfall jet, anti-limestone body jets, c.p. ABS hand shower with anti-limestone system, PVC flexible hose 150 cm.



BOX
INCASSO
BUILT-IN
BOX

WELLNESS
KIT

CROMOTERAPIA
COLOUR
THERAPIE

SOFFIONI
SHOWER
HEAD

PANNELLI
DOCCIA
SHOWER
PANELS

PANNELLI DOCCIA AD INCASSO - BUILT-IN SHOWER PANELS

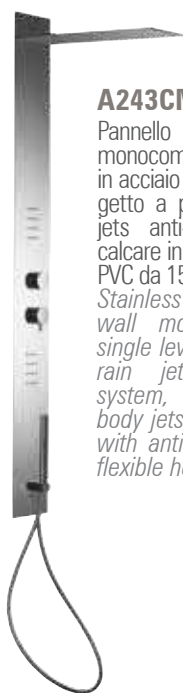
**A243CM15J**

Pannello doccia ad incasso, monocomando con deviatore a 3 vie, in acciaio INOX lucidato a specchio, getto a pioggia anti-calcare, body jets anti-calcare, doccetta anti-calcare in ABS cromato, flessibile in PVC da 150 cm.

Stainless steel mirror polished wall mounted shower panel, single lever with 3 ways diverter, rain jet with anti-limestone system, anti-limestone system body jets, c.p. ABS hand shower with anti-limestone system, PVC flexible hose 150 cm.

**A243TCM15J**

Pannello doccia ad incasso termostatico, monocomando con deviatore a 3 vie, in acciaio INOX lucidato a specchio, getto a pioggia anti-calcare, body jets anti-calcare, doccetta anti-calcare in ABS cromato, flessibile in PVC da 150 cm.

Stainless steel mirror polished wall mounted thermostatic shower panel, single lever with 3 ways diverter, rain jet with anti-limestone system, anti-limestone system body jets, c.p. ABS hand shower with anti-limestone system, PVC flexible hose 150 cm.

**A243TCM15JC**

Pannello doccia ad incasso termostatico, monocomando con deviatore a 4 vie, in acciaio INOX lucidato a specchio, getto a pioggia anti-calcare, getto a cascata, body jets anti-calcare, doccetta anti-calcare in ABS cromato, flessibile in PVC da 150 cm.

Stainless steel mirror polished wall mounted thermostatic shower panel, single lever with 4 ways diverter, rain jet with anti-limestone system, waterfall jet, anti-limestone system body jets, c.p. ABS hand shower with anti-limestone system, PVC flexible hose 150 cm.



COLONNE
DOCCIA
SHOWER
COLUMN

SALISCENDI
SLIDING
RAILS

DOCCETTE
HAND
SHOWERS

OASIS
SHUT-OFF

BOCCHIE
SPOUTS

ACCESSORI
RUBINETTERIA
TAP
ACCESSORIES



COLONNE DOCCIA SHOWER COLUMNS



Termostatico: l'utilizzo dei modelli termostatici può aiutare ad avere un maggiore controllo sul consumo di acqua ed energia.

Thermostatic: the use of thermostatic models can help you to have more control over the energy and water consumption.

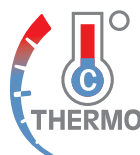

Termostatico a corpo freddo: questa tecnologia fa sì che la superficie esterna del corpo del termostatico non si surriscaldi.

Cold body thermostatic: this technology prevents the outer surface of the thermostatic mixer body from overheating.



WELLNESS

BOX
INCASSO
BUILT-IN
BOX

WELLNESS
KIT

CROMOTERAPIA
COLOUR
THERAPIE

SOFFIONI
SHOWER
HEAD

PANNELLI
DOCCIA
SHOWER
PANELS

COLONNE
DOCCIA
SHOWER
COLUMN

SALISCENDI
SLIDING
RAILS

DOCCETTE
HAND
SHOWERS

OASIS
SHUT-OFF

BOCCE
SPOUTS

ACCESSORI
RUBINETTERIA
TAP
ACCESSORIES



COLONNE DOCCIA - SHOWER COLUMNS



COLONNE DOCCIA TONDE - ROUND SHOWER COLUMN



FU636DAAD20

Miscelatore vasca/doccia con attacco superiore da 3/4" ed attacco inferiore da 1/2", colonna doccia telescopica, doccetta anticalcare a 4 funzioni con pulsante per il cambio dei getti, con flessibile A505 150 cm e soffione a pioggia, quadrato con angoli arrotondati in ABS cromato, 20x20 cm, con getti in silicone anticalcare.

Bath/shower mixer with upper 3/4" connection and lower connection 1/2", with telescopic shower column, c.p. hand shower 4 functions antilimestone with button to change jets, with A505 150 cm flexible hose and chrome plated ABS showerhead, squared with rounded edges, ultraflat, rain jet, 20x20 cm, with anti-limestone silicon jets.

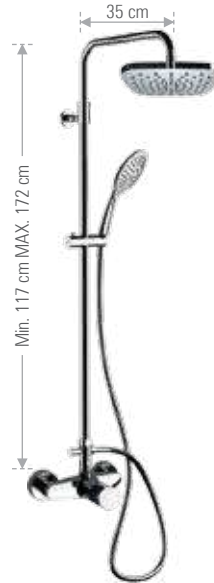

FU636AAD20

Colonna doccia con miscelatore doccia e attacco superiore da 3/4", colonna doccia telescopica con deviatore, doccetta a 4 funzioni con getti anticalcare e pulsante per il cambio dei getti, con flessibile A505 150 cm e soffione a pioggia, quadrato con angoli arrotondati in ABS cromato, 20x20 cm, con getti in silicone anticalcare.

Shower column with shower mixer and upper connection 3/4", with telescopic shower column with diverter, c.p. hand shower 4 functions with antilimestone jets and button to change jets, with A505 150 cm flexible hose and chrome plated ABS showerhead, squared with rounded edges, ultraflat, rain jet, 20x20 cm, with anti-limestone silicon jets.

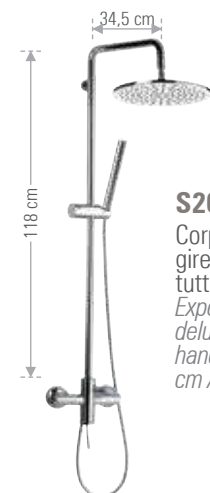

S20636C

Corpo doccia S20511Z con colonna doccia deluxe girevole, doccetta ad 1 funzione A435 e soffione tutto in ottone cromato Ø20 cm A594.

Exposed shower mixer S20511Z with swivelling deluxe shower column, c.p. brass 1 function handshower A435 and shower head all in brass Ø20 cm A594.



S20636RC

Corpo doccia S20611ZR con colonna doccia deluxe girevole, doccetta ad 1 funzione A435 e soffione Ø30 cm A594 CM30. Tutto in ottone cromato.

Exposed shower mixer S20511Z with swivelling deluxe shower column, 1 function handshower A435 and shower head Ø30 cm A594 CM30. All in c.p. brass.

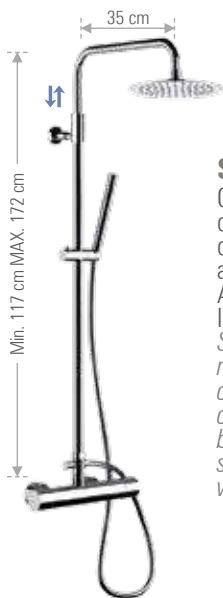

S636RA4357820

Colonna doccia serie Suvi con miscelatore doccia con deviatore integrato e attacco alto da 3/4", colonna doccia telescopica, doccetta ad 1 funzione in ottone cromato, con flessibile A505X 150 cm e soffione a pioggia, in acciaio INOX Ø 20 cm, con getti in silicone anticalcare.
Suvi series shower column with shower mixer with integrated diverter and upper connection 3/4", with telescopic shower column, c.p. handshower 1 function in c.p. brass, with A505X 150 cm flexible hose and c.p. stainless steel shower head, rain jet, Ø 20 cm, with anti-limestone silicon jets.

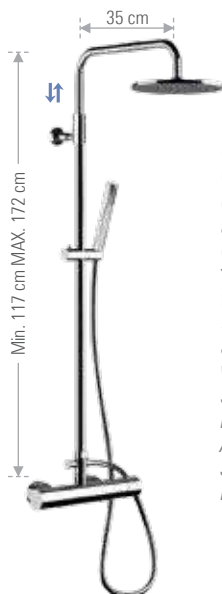

S636RA8420

Colonna doccia serie Suvi con miscelatore doccia con deviatore integrato attacco alto da 3/4", colonna doccia telescopica, doccetta anticalcare ad 1 funzione, con flessibile A505X 150 cm e soffione a pioggia, in ABS cromato, Ø 20 cm, con getti in silicone anticalcare.
Suvi series shower column with shower mixer with integrated diverter and upper connection 3/4", with telescopic shower column, c.p. handshower 1 function antilimestone, with A505X 150 cm flexible hose and c.p. ABS shower head, rain jet, Ø 20 cm, with anti-limestone silicon jets.

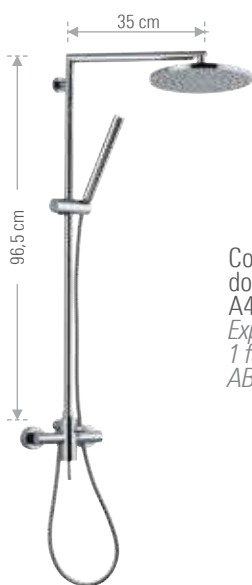

S20635

con soffione Ø20 cm A584 CM20.
with shower head Ø20 cm A584 CM20.

S20635B

con soffione Ø25 cm A584 CM25.
with shower head Ø25 cm A584 CM25.

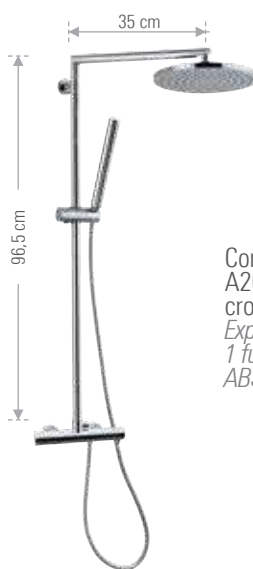

S20635R

con soffione Ø20 cm A584 CM20.
with shower head Ø20 cm A584 CM20.

S20635RB

con soffione Ø25 cm A584 CM25.
with shower head Ø25 cm A584 CM25.



TA636DA7720

Miscelatore vasca/doccia serie Tiara con attacco alto da 3-4" ed attacco inferiore da 1/2", con colonna doccia telescopica, doccetta anticalcare a 4 funzioni, con flessibile A505X 150 cm e soffione doccia quadrato con angoli arrotondati ultrapiatto in acciaio INOX 20x20 cm lucidato a specchio con getti in silicone anticalcare.
Bath/shower mixer Tiara series with upper 3/4" connection and lower connection 1/2", with telescopic shower column, c.p. handshower 4 functions antilimestone, with A505X 150 cm flexible hose and squared with rounded corners ultra slim stainless steel mirror polished shower head 20x20 cm, with anti-limestone silicon jets.

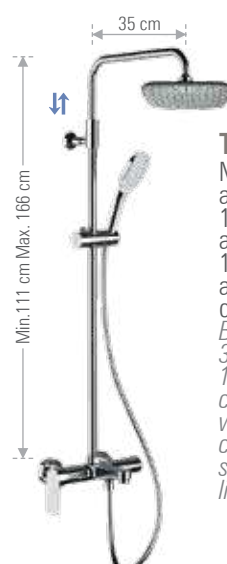

TA636DAAD20

Miscelatore vasca/doccia serie Tiara con attacco alto da 3-4" ed attacco inferiore da 1/2", con colonna doccia telescopica, doccetta anticalcare a 4 funzioni, con flessibile A505X 150 cm e soffione a pioggia quadrato con angoli arrotondati, in ABS cromato, 20x20 cm, con getti in silicone anticalcare.
Bath/shower mixer Tiara series with upper 3/4" connection and lower connection 1/2", with telescopic shower column, c.p. handshower 4 functions antilimestone, with A505X 150 cm flexible hose and c.p. ABS squared with rounded corners shower head, rain jet, 20x20 cm, with anti-limestone silicon jets.

WELLNESS

BOX
INCASSO
BUILT-IN
BOX

WELLNESS
KIT

CROMOTERAPIA
COLOUR
THERAPIE

SOFFIONI
SHOWER
HEAD

PANNELLI
DOCCIA
SHOWER
PANELS

COLONNE
DOCCIA
SHOWER
COLUMN

SALISCENDI
SLIDING
RAILS

DOCCETTE
HAND
SHOWERS

OASIS
SHUT-OFF

BOCCHIE
SPOUTS

ACCESSORI
RUBINETTERIA

TAP
ACCESSORIES

COLONNE DOCCIA - SHOWER COLUMNS



DV636B

Miscelatore doccia esterno con colonna doccia saliscendi, soffione in ottone cromato e doccetta ad 1 funzione.
Exposed shower mixer with sliding column, shower head in c.p. brass and 1 function handshower.



K18636

Miscelatore doccia esterno con deviatore integrato con colonna saliscendi con doccia anticalcare, flessibile e soffione ultrapiatto cromato.
Exposed single-lever shower mixer with diverter, with sliding column, anti-limestone handshower and extra-flat shower head.



SR636DA7820

Miscelatore vasca/doccia serie Smart con attacco alto da 3-4" ed attacco inferiore da 1/2", colonna doccia telescopica, doccetta anticalcare a 4 funzioni, con flessibile A505X 150 cm e soffione ultrapiatto Ø 20 cm, in acciaio inox lucidato a specchio con getti in silicone anticalcare.
Bath/shower mixer Smart series with upper 3/4" connection and lower connection 1/2", with telescopic shower column, c.p. handshower 4 functions antilimestone, with A505X 150 cm flexible hose and ultra slim stainless steel mirror polished shower head Ø 20 cm, with anti-limestone silicon jets.

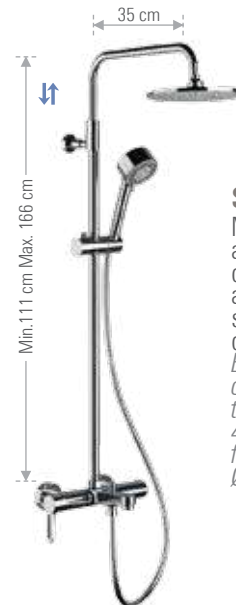

SR636DAEC20

Miscelatore vasca/doccia serie Smart con attacco alto da 3-4" ed attacco inferiore da 1/2", colonna doccia telescopica, doccetta anticalcare a 4 funzioni, con flessibile A505X 150 cm e soffione a pioggia, in ABS cromato, Ø 20 cm, con getti in silicone anticalcare.
Bath/shower mixer Smart series with upper 3/4" connection and lower connection 1/2", with telescopic shower column, c.p. handshower 4 functions antilimestone, with A505X 150 cm flexible hose and c.p. ABS shower head, rain jet, Ø 20 cm, with anti-limestone silicon jets.

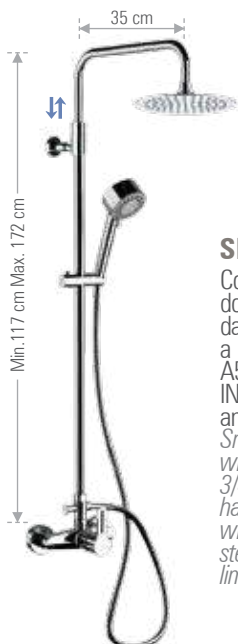

SR636A7820

Colonna doccia serie Smart con miscelatore doccia con deviatore integrato e attacco alto da 3/4", colonna doccia telescopica, doccetta a 4 funzioni con getti anticalcare, con flessibile A505X 150 cm e soffione a pioggia, in acciaio INOX cromato, Ø 20 cm, con getti in silicone anticalcare.
Smart series shower column with shower mixer with integrated diverter and upper connection 3/4", with telescopic shower column, c.p. handshower 4 functions with antilimestone jets, with A505X 150 cm flexible hose and c.p. stainless steel shower head, rain jet, Ø 20 cm, with anti-limestone silicon jets.

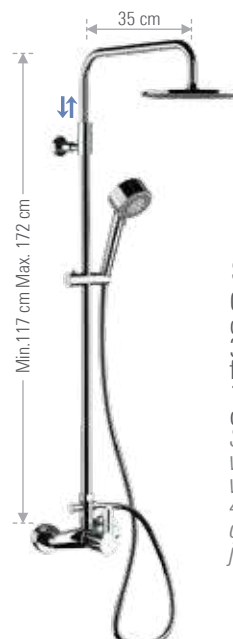

SR636A8420

Colonna doccia serie Smart con miscelatore doccia con deviatore integrato e attacco alto da 3/4", colonna doccia telescopica, doccetta a 4 funzioni con getti anticalcare, con flessibile A505X 150 cm e soffione a pioggia, in ABS cromato, Ø 20 cm, con getti in silicone anticalcare.
Smart series shower column with shower mixer with integrated diverter and upper connection 3/4", with telescopic shower column, c.p. handshower 4 functions with antilimestone jets, with A505X 150 cm flexible hose and c.p. ABS shower head, rain jet, Ø 20 cm, with anti-limestone silicon jets.

**MT16637**

Gruppo doccia con colonna e soffione doccia standard.
Shower wall-mounted mixer with column and standard shower head.

**MT16636**

Gruppo doccia con colonna saliscendi e deviatore, completa di doccetta anticalcare 4 getti, flessibile e soffione anticalcare.
Shower wall-mounted mixer with sliding rail column and diverter, complete with handshower anti-limestone 4 jets, flexible hose and shower head anti-limestone.

**J4436**

Articolo J4433Z proposto con colonna doccia A205, soffione tutto ottone A58625 e doccetta A435.
Article J4433Z with swivable sliding column A205, shower head all in brass A58625 and handshower A435.

**J4437**

Articolo J4433Z proposto con colonna doccia A250 e soffione tutto ottone A58625.
Article J4433Z with shower column A250 and shower head all brass A58625.

**J4435**

Articolo J4433Z proposto con colonna doccia A201, soffione tutto ottone A58625 e doccetta A435.
Article J4433Z with swivable sliding column A201, shower head all in brass A58625 and handshower A435.

**C4305**

Gruppo vasca con colonna doccia e soffione standard.
Bathtub mixer with standpipe and standard showerhead.

BOX
 INCASSO
 BUILT-IN
 BOX

WELLNESS
 KIT

CROMOTERAPIA
 COLOUR
 THERAPIE

SOFFIONI
 SHOWER
 HEAD

PANNELLI
 DOCCIA
 SHOWER
 PANELS

COLONNE
 DOCCIA
 SHOWER
 COLUMN

SALISCENDI
 SLIDING
 RAILS

DOCCETTE
 HAND
 SHOWERS

OASIS
 SHUT-OFF

BOCCHIE
 SPOUTS

ACCESSORI
 RUBINETTERIA
 TAP
 ACCESSORIES

COLONNE DOCCIA - SHOWER COLUMNS

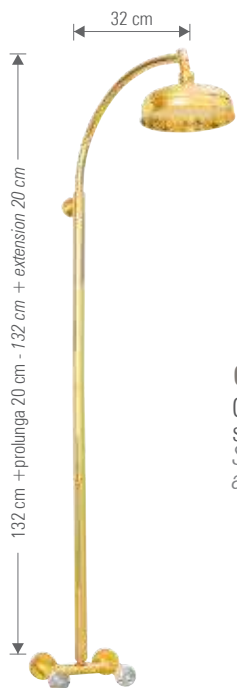

CY443789DO

Gruppo doccia con colonna girevole e soffione tutto in ottone.
Shower mixer with column and shower head all in brass.



CY443689DO

Gruppo doccia con colonna saliscendi girevole con deviatore doccetta, flessibile e soffione.
Shower mixer with sliding rail column with diverter shower, flexible and shower head.



RY413689DO

Gruppo vasca con colonna saliscendi girevole e deviatore con doccia, flessibile e soffione tutto in ottone.
Bathtub mixer with sliding rail column and diverter with shower, flexible and shower head all in brass.



RY443689DO

Gruppo doccia con colonna saliscendi girevole e deviatore con doccia, flessibile e soffione tutto in ottone.
Shower mixer with sliding rail column and diverter with shower, flexible and shower head all in brass.

**V4137**

Gruppo vasca con colonna girevole e soffione tutto in ottone cromato.
Bathtub mixer with column and shower head all in c.p. brass.

**V4136**

Gruppo vasca con colonna saliscendi girevole e deviatore con doccia, flessibile e soffione tutto in ottone cromato.
Bathtub mixer with sliding rail column and diverter with shower, flexible and shower head all in brass.

**V4437**

Gruppo doccia con colonna girevole e soffione tutto in ottone cromato.
Shower mixer with column and shower head all in C.P. brass.

**V4436**

Gruppo doccia con colonna saliscendi girevole e deviatore con doccia, flessibile e soffione tutto in ottone cromato.
Shower mixer with sliding rail column and diverter with shower, flexible and shower head all in c.p. brass.

BOX
INCASSO
BUILT-IN
BOX

WELLNESS
KIT

CROMOTERAPIA
COLOUR
THERAPIE

SOFFIONI
SHOWER
HEAD

PANNELLI
DOCCIA
SHOWER
PANELS

COLONNE
DOCCIA
SHOWER
COLUMN

SALISCENDI
SLIDING RAILS

DOCCETTE
HAND
SHOWERS

OASIS
SHUT-OFF

BOCCHE
SPOUTS

ACCESSORI
RUBINETTERIA
TAP
ACCESSORIES

COLONNE DOCCIA - SHOWER COLUMNS



RT4137

Gruppo vasca con colonna girevole e soffione tutto in ottone cromato.
Bathtub mixer with column and shower head all in brass.



RT4136

Gruppo vasca con colonna saliscendi girevole e deviatore con doccia, flessibile e soffione tutto in ottone cromato.
Bathtub mixer with sliding rail column and diverter with shower, flexible and shower head all in brass.



RT4437

Gruppo doccia con colonna girevole e soffione tutto in ottone cromato.
Shower mixer with swivelling column and shower head all in C.P. brass.



RT4436

Gruppo doccia con colonna saliscendi girevole e deviatore con doccia, flessibile e soffione tutto in ottone cromato.
Shower mixer with sliding rail column and diverter with shower, flexible and shower head all in C.P. brass.

**L4437**

Gruppo vasca con colonna girevole e soffione tutto in ottone cromato.
Bathtub mixer with column and shower head all in brass.

**L4436**

Gruppo vasca con colonna saliscendi girevole con deviatore doccetta, flessibile e soffione.
Bathtub mixer with sliding rail column with diverter shower, flexible and shower head.

**MI4437**

Gruppo doccia con colonna girevole e soffione tutto in ottone cromato.
Shower mixer with column and shower head all in brass.

**MI4436**

Gruppo doccia con colonna saliscendi girevole con deviatore doccetta, flessibile e soffione.
Shower mixer with sliding rail column with diverter shower, flexible and shower head.

BOX
INCASSO
BUILT-IN
BOX

WELLNESS
KIT

CROMOTERAPIA
COLOUR
THERAPIE

SOFFIONI
SHOWER
HEAD

PANNELLI
DOCCIA
SHOWER
PANELS

COLONNE
DOCCIA
SHOWER
COLUMN

SALISCENDI
SLIDING RAILS

DOCCETTE
HAND
SHOWERS

OASIS
SHUT-OFF

BOCCE
SPOUTS

ACCESSORI
RUBINETTERIA
TAP
ACCESSORIES

COLONNE DOCCIA - SHOWER COLUMNS



COLONNE DOCCIA QUADRATE - SQUARED SHOWER COLUMN



SK637Q

Corpo doccia con colonna e soffione tutto in ottone cromato.
Exposed shower mixer with shower column and shower head all in brass.



SK636Q

Corpo doccia con colonna, doccetta ad 1 funzione e soffione tutto in ottone cromato.
Exposed shower mixer with shower column, 1 function handshower and shower head all in brass.

**OX23637Q**

Corpo doccia con colonna e soffione tutto in ottone cromato.
Exposed shower mixer with shower column and shower head all in brass.

**OX23636Q**

Corpo doccia con colonna, doccetta ad 1 funzione e soffione tutto in ottone cromato.
Exposed shower mixer with shower column, 1 function handshower and shower head all in brass.

**W4437R**

Corpo doccia con colonna e soffione tutto in ottone cromato.
Exposed shower mixer with shower column and shower head all in brass.

**W4436R**

Corpo doccia con colonna e soffione in ottone cromato, doccetta ad 1 funzione.
Exposed shower mixer with shower column and shower head all in brass, 1 function handshower.

BOX
INCASSO
BUILT-IN
BOX

WELLNESS
KIT

CROMOTERAPIA
COLOUR
THERAPIE

SOFFIONI
SHOWER
HEAD

PANNELLI
DOCCIA
SHOWER
PANELS

COLONNE
DOCCIA
SHOWER
COLUMN

SALISCENDI
SLIDING
RAILS

DOCCETTE
HAND
SHOWERS

OASIS
SHUT-OFF

BOCCHIE
SPOUTS

ACCESSORI
RUBINETTERIA
TAP
ACCESSORIES

COLONNE DOCCIA - SHOWER COLUMNS



COLONNE DOCCIA TERMOSTATICHE TONDE - ROUND THERMOSTATIC SHOWER COLUMN



XF636A7820

Miscelatore doccia termostatico con attacco alto da 3-4" ed attacco inferiore da 1/2" con deviatore integrato, colonna doccia telescopica, doccetta anticalcare a 4 funzioni, con flessibile A505X 150 cm e soffione ultrapiatto Ø 20 cm, in acciaio INOX lucidato a specchio.

Thermostatic shower mixer with upper 3/4" connection and lower connection 1/2" with integrated diverter, telescopic shower column, c.p. handshower 4 functions antilimestone, with A505X 150 cm flexible hose and ultra slim stainless steel mirror polished shower head Ø 20 cm.



XF636A7825

Miscelatore doccia termostatico con attacco alto da 3-4" ed attacco inferiore da 1/2" con deviatore integrato, colonna doccia telescopica, doccetta anticalcare a 4 funzioni, con flessibile A505X 150 cm e soffione ultrapiatto Ø 25 cm, in acciaio INOX lucidato a specchio.

Thermostatic shower mixer with upper 3/4" connection and lower connection 1/2" with integrated diverter, telescopic shower column, c.p. handshower 4 functions antilimestone, with A505X 150 cm flexible hose and ultra slim stainless steel mirror polished shower head Ø 25 cm.



XF636A3CP7720

Miscelatore doccia termostatico con attacco alto da 3-4" ed attacco inferiore da 1/2" con deviatore integrato, colonna doccia telescopica, doccetta anticalcare a 4 funzioni, con pulsante per il cambio dei getti e flessibile A505X 150 cm e soffione ultrapiatto 20x20 cm, in acciaio INOX lucidato a specchio.

Thermostatic shower mixer with upper 3/4" connection and lower connection 1/2" with integrated diverter, telescopic shower column, c.p. handshower 4 functions antilimestone with button to change jets, with A505X 150 cm flexible hose and ultra slim stainless steel mirror polished shower head 20x20 cm.

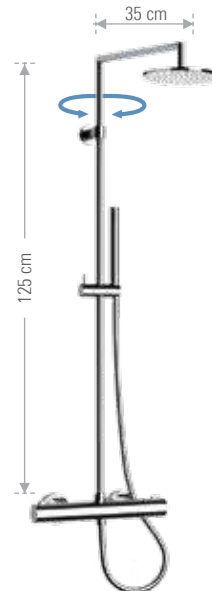

XF636N18

Set doccia composto da miscelatore termostatico esterno doccia con deviatore integrato, colonna doccia minimale Ø 18 mm, dado da 1/2", con saliscendi, doccetta anticalcare in ABS cromato, soffione in ABS cromato anticalcare Ø 25 cm. Flessibile 150 cm.

Shower set composed by external thermostatic shower single lever mixer with integrated diverter, minimal shower column Ø 18 mm, nut 1/2", with sliding central, anti-limestone handshower in ABS, showerhead in c.p. ABS Ø 25 cm with silicone jets anti-limestone. Shower flexible hose 150 cm.



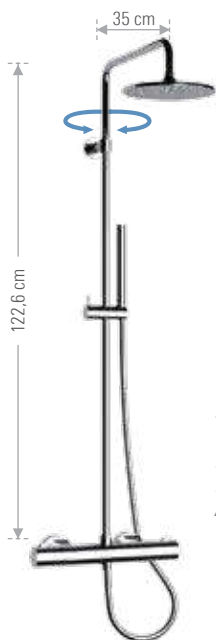

XF636U18

Set doccia composto da Miscelatore termostatico esterno doccia con deviatore integrato, colonna doccia deluxe Ø 18 mm, dado da 1/2", con saliscendi, doccetta anticalcare in ottone cromato e soffione in ABS cromato e anticalcare. Flessibile 150 cm.

Shower set composed by external thermostatic shower single lever mixer with integrated diverter, deluxe shower column Ø 18 mm, nut 1/2", mm with sliding central, including anti-limestone handshower in c.p. brass and showerhead in c.p. ABS with anti-limestone silicone jets. Shower flexible hose 150 cm.

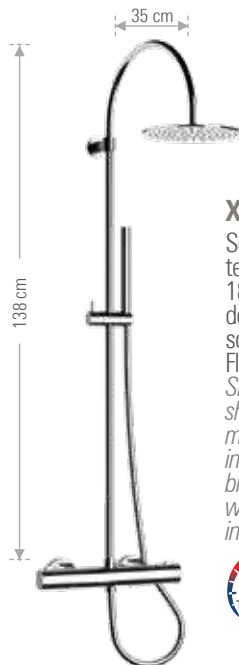

XF636L18

Set doccia composto da miscelatore termostatico esterno doccia, colonna doccia Ø 18 mm, dado da 1/2", con saliscendi e deviatore, doccetta anticalcare in ottone cromato e soffione in ABS cromato e anticalcare Ø20 cm. Flessibile in ottone cromato incluso.

Shower set composed by external thermostatic shower single lever mixer, shower column Ø 18 mm, nut 1/2", with sliding central and diverter, including anti-limestone handshower in c.p. brass and showerhead in c.p. ABS 359 Ø20 cm with silicone jets anti-limestone. Shower flexible in c.p. brass included.



XF636A3CP7725

Miscelatore doccia termostatico con attacco alto da 3-4" ed attacco inferiore da 1/2" con deviatore integrato, colonna doccia telescopica, doccetta anticalcare a 4 funzioni, con pulsante per il cambio dei getti e flessibile A505X 150 cm e soffione ultrapiatto 25x25 cm, in acciaio INOX lucidato a specchio.

Thermostatic shower mixer with upper 3/4" connection and lower connection 1/2" with integrated diverter, telescopic shower column, c.p. handshower 4 functions antilimestone with button to change jets, with A505X 150 cm flexible hose and ultra slim stainless steel mirror polished shower head 25x25 cm.



XF636A3CPAD20

Miscelatore doccia termostatico con attacco alto da 3-4" ed attacco inferiore da 1/2" con deviatore integrato, colonna doccia telescopica, doccetta anticalcare a 4 funzioni, con pulsante per il cambio dei getti e flessibile A505X 150 cm e soffione a pioggia squadrato con angoli arrotondati, in ABS cromato, 20x20 cm, con getti in silicone anticalcare.

Thermostatic shower mixer with upper 3/4" connection and lower connection 1/2" with integrated diverter, telescopic shower column, c.p. handshower 4 functions antilimestone with button to change jets, with A505X 150 cm flexible hose and c.p. ABS squared with rounded corners shower head, rain jet, 20x20 cm, with anti-limestone silicon jets.



XF636A3MP8420

Miscelatore doccia termostatico con attacco alto da 3-4" ed attacco inferiore da 1/2" con deviatore integrato, colonna doccia telescopica, doccetta anticalcare a 4 funzioni, con pulsante per il cambio dei getti e flessibile A505X 150 cm e soffione lusso a pioggia, in ABS cromato, Ø 20 cm, con getti in silicone anticalcare.

Thermostatic shower mixer with upper 3/4" connection and lower connection 1/2" with integrated diverter, telescopic shower column, c.p. handshower 4 functions antilimestone with button to change jets, with A505X 150 cm flexible hose and c.p. deluxe ABS shower head, rain jet, Ø 20 cm, with anti-limestone silicon jets.

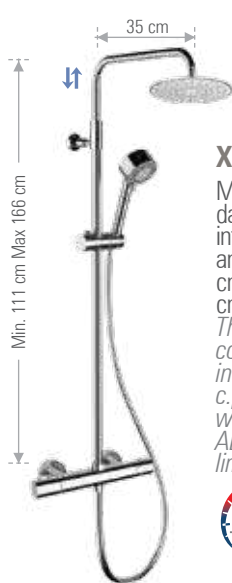

XF636AEC20

Miscelatore doccia termostatico con attacco alto da 3-4" ed attacco inferiore da 1/2" con deviatore integrato, colonna doccia telescopica, doccetta anticalcare a 4 funzioni, con flessibile A505X 150 cm e soffione a pioggia, in ABS cromato, Ø 20 cm, con getti in silicone anticalcare.

Thermostatic shower mixer with upper 3/4" connection and lower connection 1/2" with integrated diverter, telescopic shower column, c.p. handshower 4 functions antilimestone, with A505X 150 cm flexible hose and c.p. ABS shower head, rain jet, Ø 20 cm, with anti-limestone silicon jets.



WELLNESS

BOX
INCASSO
BUILT-IN
BOX

WELLNESS
KIT

CROMOTERAPIA
COLOUR
THERAPIE

SOFFIONI
SHOWER
HEAD

PANNELLI
DOCCIA
SHOWER
PANELS

COLONNE
DOCCIA
SHOWER
COLUMN

SALISCENDI
SLIDING
RAILS

DOCCETTE
HAND
SHOWERS

OASIS
SHUT-OFF

BOCCHIE
SPOUTS

ACCESSORI
RUBINETTERIA
TAP
ACCESSORIES

COLONNE DOCCIA - SHOWER COLUMNS

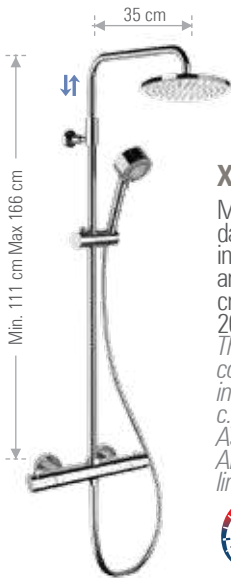

XF636A8420

Miscelatore doccia termostatico con attacco alto da 3/4" ed attacco inferiore da 1/2" con deviatore integrato, colonna doccia telescopica, doccetta anticalcare a 4 funzioni, con flessibile A505X 150 cm e soffione lusso a pioggia, in ABS cromato, Ø 20 cm, con getti in silicone anticalcare.

Thermostatic shower mixer with upper 3/4" connection and lower connection 1/2" with integrated diverter, telescopic shower column, c.p. handshower 4 functions antilimestone, with A505X 150 cm flexible hose and c.p. deluxe ABS shower head, rain jet, Ø 20 cm, with anti-limestone silicon jets.

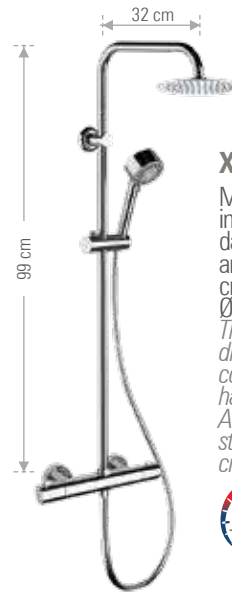

XF636X7820

Miscelatore doccia termostatico con deviatore integrato, attacco alto da 3/4", attacco inferiore da 1/2", colonna doccia Minimale, doccetta anticalcare a 4 funzioni, con flessibile A505X 150 cm e soffione in acciaio INOX lucidato a specchio, Ø 20 cm, con getti in silicone anticalcare.

Thermostatic shower mixer with integrated diverter, upper 3/4" connection and lower connection 1/2", Minimal shower column, c.p. handshower 4 functions antilimestone, with A505X 150 cm flexible hose and ultra slim stainless steel mirror polished shower head, Ø 20 cm, with anti-limestone silicon jets.



XF636X7825

Miscelatore doccia termostatico con deviatore integrato, attacco alto da 3/4", attacco inferiore da 1/2", colonna doccia Minimale, doccetta anticalcare a 4 funzioni, con flessibile A505X 150 cm e soffione in acciaio INOX lucidato a specchio, Ø 25 cm, con getti in silicone anticalcare.

Thermostatic shower mixer with integrated diverter, upper 3/4" connection and lower connection 1/2", Minimal shower column, c.p. handshower 4 functions antilimestone, with A505X 150 cm flexible hose and ultra slim stainless steel mirror polished shower head Ø 25 cm, with anti-limestone silicon jets.

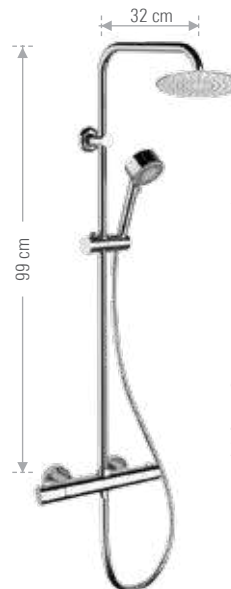

XF636XEC20

Miscelatore doccia termostatico con deviatore integrato, attacco alto da 3/4", attacco inferiore da 1/2", colonna doccia Minimale, doccetta anticalcare a 4 funzioni, con flessibile A505X 150 cm e soffione Ø 20 cm, in ABS cromato con getti in silicone autopulenti ed anticalcare.

Thermostatic shower mixer with integrated diverter, upper 3/4" connection, lower connection 1/2", Minimal shower column, c.p. handshower 4 functions antilimestone, with A505X 150 cm flexible hose and c.p. ABS shower head Ø 20 cm with selfcleaning and antilimestone silicon jets.



XF636X3CP7725

Miscelatore doccia termostatico con deviatore integrato, attacco alto da 3/4", attacco inferiore da 1/2", colonna doccia Minimale, doccetta anticalcare a 4 funzioni, con pulsante per il cambio dei getti e flessibile A505X 150 cm e soffione in acciaio INOX lucidato a specchio, 25x25 cm, con getti in silicone anticalcare.

Thermostatic shower mixer with integrated diverter, upper 3/4" connection and lower connection 1/2", Minimal shower column, c.p. handshower 4 functions antilimestone with button to change jets, with A505X 150 cm flexible hose and and stainless steel mirror polished squared with rounded corners shower head, 25x25 cm, with anti-limestone silicon jets.

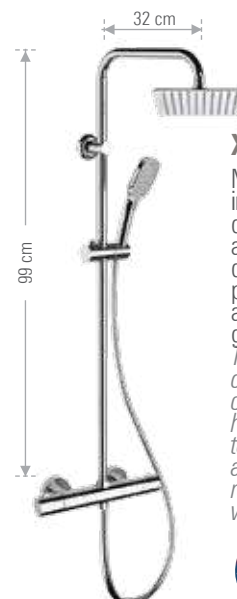

XF636X3CP7720

Miscelatore doccia termostatico con deviatore integrato, attacco alto da 3/4", attacco inferiore da 1/2", colonna doccia Minimale, doccetta anticalcare a 4 funzioni, con pulsante per il cambio dei getti e flessibile A505X 150 cm e soffione a pioggia squadrato con angoli arrotondati, in acciaio INOX lucidato a specchio, 20x20 cm, con getti in silicone anticalcare.

Thermostatic shower mixer with integrated diverter upper connection 3/4" and lower connection 1/2", Minimal shower column, c.p. handshower 4 functions antilimestone with button to change jets, with A505X 150 cm flexible hose and stainless steel mirror polished squared with rounded corners shower head, rain jet, 20x20 cm, with anti-limestone silicon jets.



**XF636U**

Miscelatore doccia termostatico con deviatore integrato, attacco alto da 3/4", attacco inferiore da 1/2", colonna doccia minimale, doccetta in ottone cromato ad 1 funzione, con flessibile in ottone cromato 150 cm e soffione in ottone Ø 20 cm con getti in silicone anticalcare.

Thermostatic shower mixer with integrated diverter, upper 3/4" connection and lower connection 1/2", minimal shower column, c.p. brass handshower 1 functions, with c.p. brass 150 cm flexible hose and c.p. brass shower head Ø 20 cm with anti-limestone silicon jets.

**XF636X8420**

Miscelatore doccia termostatico con deviatore integrato, attacco alto da 3/4", attacco inferiore da 1/2", colonna doccia Minimale, doccetta anticalcare a 4 funzioni, con flessibile A505X 150 cm e soffione Ø 20 cm, in ABS cromato con getti in silicone autopulenti ed anticalcare.

Thermostatic shower mixer with integrated diverter, upper 3/4" connection and lower connection 1/2", Minimal shower column, c.p. handshower 4 functions antilimestone, with A505X 150 cm flexible hose and c.p. ABS shower head Ø 20 cm with selfcleaning and antilimestone silicon jets.

**XF636X3CPAD20**

Miscelatore doccia termostatico con deviatore integrato, attacco alto da 3/4", attacco inferiore da 1/2", colonna doccia Minimale, doccetta anticalcare a 4 funzioni, con pulsante per il cambio dei getti e flessibile A505X 150 cm e soffione in ABS cromato con getti in silicone autopulenti ed anticalcare, 20x20 cm.

Thermostatic shower mixer with integrated diverter, upper 3/4" connection and lower connection 1/2", Minimal shower column, c.p. handshower 4 functions antilimestone with button to change jets, with A505X 150 cm flexible hose and c.p. ABS shower head 20x20 cm with selfcleaning and antilimestone silicon jets.

**XF636X3MP8420**

Miscelatore doccia termostatico con deviatore integrato, attacco alto da 3/4", attacco inferiore da 1/2", colonna doccia Minimale, doccetta anticalcare a 3 funzioni, con pulsante per il cambio dei getti e flessibile A505X 150 cm e soffione Ø 20 cm in ABS cromato con getti in silicone autopulenti ed anticalcare.

Thermostatic shower mixer with integrated diverter, upper 3/4" connection and lower connection 1/2", Minimal shower column, c.p. handshower 3 functions antilimestone with button to change jets, with A505X 150 cm flexible hose and c.p. ABS shower head Ø 20 cm with selfcleaning and antilimestone silicon jets.

**ST20636C**

Miscelatore termostatico esterno doccia con colonna, deviatore, soffione Ø30 cm, doccetta ad 1 funzione. Tutto in ottone cromato.

Thermostatic exposed single lever shower mixer with shower column, diverter, shower head Ø30 cm, 1 function handshower. All in brass.

**ST20636VC**

Miscelatore termostatico esterno doccia con colonna, soffione Ø30 cm, doccetta ad 1 funzione. Tutto in ottone cromato.

Thermostatic exposed single lever shower mixer with shower column, shower head Ø30 cm, 1 function handshower. All in brass.

BOX
INCASSO
BUILT-IN
BOXWELLNESS
KITCROMOTERAPIA
COLOUR
THERAPIESOFFIONI
SHOWER
HEADPANNELLI
DOCCIA
SHOWER
PANELSCOLONNE
DOCCIA
SHOWER
COLUMNSALISCENDI
SLIDING
RAILSDOCCETTE
HAND
SHOWERSOASIS
SHUT-OFFBOCCHE
SPOUTSACCESSORI
RUBINETTERIA
TAP
ACCESSORIES

COLONNE DOCCIA - SHOWER COLUMNS



Miscelatore termostatico esterno doccia con colonna, deviatore, doccetta ad 1 funzione e soffione.

Thermostatic exposed single lever shower mixer with shower column, diverter, 1 function handshower and shower head.



ST20635

con soffione Ø20 cm.
with shower head Ø20 cm.

ST20635B

con soffione Ø25 cm.
with shower head Ø25 cm.



Miscelatore termostatico esterno doccia con colonna, doccetta ad 1 funzione e soffione.

Thermostatic exposed single lever shower mixer with shower column, 1 function handshower and shower head.



ST20635V

con soffione Ø20 cm.
with shower head Ø20 cm.

ST20635VB

con soffione Ø25 cm.
with shower head Ø25 cm.

COLONNE DOCCIA TERMOSTATICHE TONDE A CORPO FREDDO ROUND COLD BODY THERMOSTATIC SHOWER COLUMN



STF20636C

Miscelatore termostatico a corpo freddo esterno doccia STF20611D con deviatore integrato, colonna doccia deluxe con saliscendi, doccetta anticalcare in ottone cromato e soffione ultrapiatto in ottone cromato e anticalcare Ø 35 cm. Flessibile in ottone cromato 150 cm.

Cold body external thermostatic shower single lever mixer STF20611D with integrated diverter, deluxe shower column with sliding central, including antilimestone handshower in c.p. brass and ultrathin showerhead in c.p. brass Ø 35 cm with silicone jets, antilimestone. Shower flexible in c.p. brass 150 cm.





COLONNE DOCCIA TERMOSTATICHE QUADRATE - SQUARED THERMOSTATIC SHOWER COLUMN



ZT636

Colonna doccia quadrata con miscelatore doccia termostatico con deviatore integrato, attacco alto da 3/4", colonna doccia in ottone cromato e doccetta in ABS ad 1 funzione, con flessibile A505X 150 cm e soffione a snodo, cromato-satinato 23x23 cm, con getti effetto pioggia in silicone, anticalcare.

Squared shower column with thermostatic shower mixer with integrated diverter and upper connection 3/4", with c.p. brass shower column, ABS c.p. handshower 1 function, with A505X 150 cm flexible hose and chrome-satin shower head, rain jet, 23x23 cm, with balljoint and anti-limestone silicon jets.



ZT636B

Colonna doccia quadrata con miscelatore doccia termostatico con deviatore integrato, attacco alto da 3/4", colonna doccia in ottone cromato e doccetta quadrata ad 1 funzione con getti in silicone, anticalcare, flessibile A505X 150 cm e soffione ultra piatto 20x20 cm in acciaio INOX lucidato a specchio, con getti effetto pioggia in silicone, anticalcare.

Squared shower column with thermostatic shower mixer with integrated diverter and upper connection 3/4", with c.p. brass shower column, squared handshower 1 function, anti-limestone with silicon jets, with A505X 150 cm flexible hose and ultra slim stainless steel mirror polished shower head 20x20 cm, with anti-limestone silicon jets.



SKT636QB

Corpo doccia termostatico con colonna quadrata, deviatore, doccetta ad 1 funzione e soffione anticalcare 35x35 cm. Tutto in ottone cromato.

Thermostatic exposed shower mixer with squared shower column, diverter, 1 function handshower and antilimestone shower head 35x35 cm. All in brass.



SKT636Q

Corpo doccia termostatico con colonna, deviatore, doccetta ad 1 funzione e soffione anticalcare 20x20 cm. Tutto in ottone cromato.

Thermostatic exposed shower mixer with shower column, diverter, 1 function handshower and antilimestone shower head 20x20 cm. All in brass.



COLONNE DOCCIA - SHOWER COLUMNS



SKT636QVB

Corpo doccia termostatico, colonna doccia quadrata, deviatore, doccetta ad 1 funzione e soffione anticalcare quadrato 35x35 cm. Tutto in ottone cromato.

Thermostatic exposed shower mixer with squared shower column, diverter, 1 function handshower and antilimestone squared shower head 35x35 cm. All in c.p. brass.



SKT636QV

Corpo doccia termostatico, colonna doccia quadrata, deviatore, doccetta ad 1 funzione e soffione anticalcare quadrato 20x20 cm. Tutto in ottone cromato.

Thermostatic exposed shower mixer with squared shower column, diverter, 1 function handshower and antilimestone squared shower head 20x20 cm. All in c.p. brass.



COLONNE DOCCIA TERMOSTATICHE QUADRATE A CORPO FREDDO SQUARED COLD BODY THERMOSTATIC SHOWER COLUMN



SKTF636QB

Miscelatore termostatico esterno doccia a corpo freddo SKTF611D con colonna doccia quadra con saliscendi, doccetta ad 1 funzione completamente in ottone cromato e e soffione anticalcare 35x35 cm.

Flessibile in ottone cromato incluso.

External cold body thermostatic shower single lever mixer SKTF611D with squared shower column with sliding central, including 1 function handshower and antilimestone showerhead all in c.p. brass 35x35 cm with silicone jets, antilimestone.

Shower flexible in c.p. brass included.





COLONNE DOCCIA FREESTANDING - FREESTANDING SHOWER COLUMN



A291636

Colonna con miscelatore acqua calda-fredda saliscendi free-standing con attacco da pavimento, con deviatore, doccetta e flessibile doccia cm 200, soffione anticalcare Ø 30 cm.

Free-standing column with single lever mixer hot/cold water control, with diverter and sliding bar, with handshower, flexible cm 200 and antilimestone shower head Ø 30 cm



A291637

Colonna free-standing con miscelatore acqua calda-fredda, con attacco da pavimento, con soffione anticalcare Ø 30 cm.

Free-standing chrome plated brass column with single lever mixer hot/cold water control, with anti-limestone shower head Ø 30 cm.

BOX
INCASSO
BUILT-IN
BOX

WELLNESS
KIT

CROMOTERAPIA
COLOUR
THERAPIE

SOFFIONI
SHOWER
HEAD

PANNELLI
DOCCIA
SHOWER
PANELS

COLONNE
DOCCIA
SHOWER
COLUMN

SALISCENDI
SLIDING
RAILS

DOCCETTE
HAND
SHOWERS

OASIS
SHUT-OFF

BOCCE
SPOUTS

ACCESSORI
RUBINETTERIA
TAP
ACCESSORIES

COLONNE DOCCIA - SHOWER COLUMNS



A292

Colonna doccia da esterno in acciaio INOX, monocomando a 2 vie con getto pioggia anticalcare e getto cascata, acqua calda-fredda con attacco da pavimento,
Stainless steel shower column from outside, single lever 2 ways diverter rain jet with anti-limestone system and waterfall jet, mixer hot/ cold water control for shower, floor mounted.



FREESTANDING MONOACQUA - SINGLE WATER FREESTANDING



A290636

Colonna saliscendi free-standing in ottone cromato con attacco da pavimento, con comando monoacqua, deviatore, doccetta ad 1 funzione e flessibile doccia cm 200, soffione anticalcare Ø 30 cm.
Free-standing chrome plated brass column with single water control, with diverter and sliding bar, with c.p. brass handshower with flexible cm 200 and shower head Ø 30 cm.

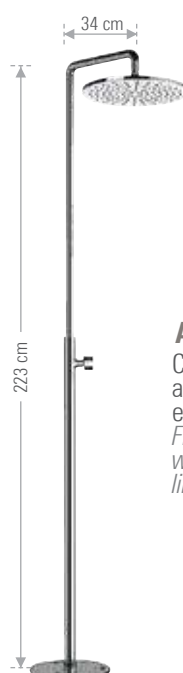

A290637

Colonna free-standing in ottone cromato con attacco da pavimento, con comando monoacqua e soffione anticalcare Ø 30 cm.
Free-standing chrome plated brass column with single water control, with c.p. brass anti-limestone shower head Ø 30 cm

COLONNE DOCCIA - SHOWER COLUMN

**A252**

Colonna doccia.
Altezza: 96 cm.
Interasse: 32 cm.
*Shower column.
Height: 96 cm.
Ineraxis: 32 cm.*

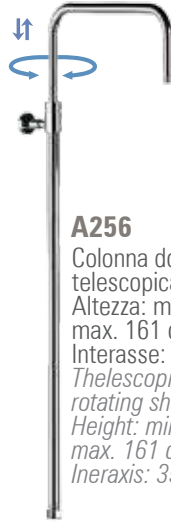
**A256**

Colonna doccia
telescopica e girevole.
Altezza: min. 106
max. 161 cm.
Interasse: 35 cm.
*Thelescopic and
rotating shower column.
Height: min. 106
max. 161 cm.
Ineraxis: 35 cm.*

**A254**

Colonna doccia.
Altezza: 96 cm.
Interasse: 23 cm.
*Shower column.
Height: 96 cm.
Ineraxis: 23 cm.*

**A250**

Colonna doccia girevole.
Altezza: 132 cm.
Interasse: 32 cm.
*Rotating shower column.
Height: 132 cm.
Ineraxis: 32 cm.*

**A235**

Colonna doccia.
Altezza: 100 cm.
Interasse: 39 cm.
*Shower column.
Height: 100 cm.
Ineraxis: 39 cm.*

**A251**

Colonna doccia girevole.
Altezza: 93,5 cm.
Interasse: 33,5 cm.
*Rotating shower
column.
Height: 93,5 cm.
Ineraxis: 33,5 cm.*

**A253**

Colonna doccia.
Altezza: 96 cm.
Interasse: 32 cm.
*Shower column.
Height: 96 cm.
Ineraxis: 32 cm.*

**A255**

Colonna doccia girevole.
Altezza: 116 cm. - Interasse: 41 cm.
*Rotating Shower column.
Height: 116 cm. - Ineraxis: 41 cm.*

**A230**

Colonna doccia.
Altezza: 100 cm. - Interasse: 39 cm.
*Shower column.
Height: 100 cm. - Ineraxis: 39 cm.*

BOX
INCASSO
BUILT-IN
BOX

WELLNESS
KIT

CROMOTERAPIA
COLOUR
THERAPIE

SOFFIONI
SHOWER
HEAD

PANNELLI
DOCCIA
SHOWER
PANELS

COLONNE
DOCCIA
SHOWER
COLUMN

SALISCENDI
SLIDING
RAILS

DOCCETTE
HAND
SHOWERS

OASIS
SHUT-OFF

BOCCH
SPOUTS

ACCESSORI
RUBINETTERIA
TAP
ACCESSORIES

COLONNE DOCCIA - SHOWER COLUMNS

COLONNE DOCCIA CON SUPPORTO DOCCIA E FLESSIBILE SHOWER COLUMN WITH SHOWER SUPPORT AND FLEXIBLE HOSE



Tubo in ottone cromato per estensione dell'Altezza delle colonne A200, A205, A250 e A255, Ø 22 mm.
C.p. brass pipe for the extension of height of columns art A200, A205, A250 and A255, for pipe Ø 22 mm.

A205PROL10 cm 10

A205PROL20 cm 20

A205PROL40 cm 40



A201PROL20

Tubo in ottone cromato per estensione dell'Altezza delle colonne A201 e A251, lunghezza cm 20, Ø 25 mm.

C.p. brass pipe for the extension of height of columns art A201 and A251, length 20 cm for pipe Ø 25 mm.



A203PROL20

Prolunga per miscelatore da soffitto, per art. A203, A204, A253, A254 lunghezza 20 cm, Ø35 mm, in ottone cromato.

Extension for ceiling mixer length 20 cm, Ø35 mm, in chrome plated brass for art. A203, A204, A253, A254.



A240PROL10

Tubo in ottone cromato per estensione dell'Altezza della colonna art. A230 e A240, lunghezza cm 10 cm.

C.p. brass pipe for the extension of height of columns art A230 and A240, length 10 cm.



A240PROL20

Tubo in ottone cromato per estensione dell'Altezza della colonna art. A230 e A240, lunghezza cm 20 cm.

C.p. brass pipe for the extension of height of columns art A230 and A240, length 20 cm.



A205FL

Flessibile doccia per collegamento colonna doccia-miscelatore, attacco 1/2F x 1/2F, lunghezza 50 cm.

Flexible shower hose for connection shower column-mixer, connection 1/2F x 1/2F, length cm 50.



A300SUP

Presse d'acqua - supporto a muro "minimal" per colonne doccia, multifunzione.

Punch for water outlet and wall bearing "minimal" for shower columns, multifunction.



A305SUP

Presse d'acqua - supporto a muro "quadrato" per colonne doccia, multifunzione.

Punch for water outlet and wall bearing "squared" for shower columns, multifunction.



A303SUP

Supporto inferiore per colonna da 3/4 con passaggio acqua esterno tramite collegamento 1/2.

Lower holder for column 3/4 with external water connector 1/2.



A307SUP

Supporto per colonna da 3/4 con deviatore integrato e presa acqua inferiore 1/2.

Support for 3/4 shower column with integrated diverter and lower water punch connector 1/2.



A205DEV

Deviatore con molla e fermo, per colonne 3/4M x 3/4F x 1/2M.

Diverter with spring and stop, for columns, 3/4M x 3/4F x 1/2M.



A240DEV

Deviatore squadrato per colonne doccia, con molla e fermo 3/4M x 3/4F x 1/2M.

Squared diverter for shower columns, with spring and stop, 3/4M x 3/4F x 1/2M.

BOX
INCASSO
BUILT-IN
BOX

WELLNESS
KIT

CROMOTERAPIA

COLOUR
THERAPIE

SOFFIONI
SHOWER
HEAD

PANNELLI
DOCCIA

SHOWER
PANELS

COLONNE
DOCCIA
SHOWER
COLUMN

SALISCENDI
SLIDING RAILS

DOCCETTE
HAND
SHOWERS

OASIS
SHUT-OFF

BOCCHE
SPOUTS

ACCESSORI
RUBINETTERIA
TAP
ACCESSORIES



SALISCENDI SLIDING RAILS



WELLNESS

BOX
INCASSO
BUILT-IN
BOX

WELLNESS
KIT

CROMOTERAPIA
COLOUR
THERAPIE

SOFFIONI
SHOWER
HEAD

PANNELLI
DOCCIA
SHOWER
PANELS



COLONNE
DOCCIA
SHOWER
COLUMN

SALISCENDI
SLIDING
RAILS

DOCCETTE
HAND
SHOWERS

OASIS
SHUT-OFF

BOCCE
SPOUTS

ACCESSORI
RUBINETTERIA
TAP
ACCESSORIES

SALISCENDI CON DOCCETTA - SLIDING RAILS WITH HAND SHOWER

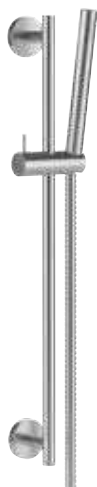

SSA335 435

Saliscendi minimale con doccia ad 1 funzione tutto in acciaio INOX spazzolato.
Altezza 96 cm.
Minimal sliding rail set with 1 function handshower all in brushed stainless steel.
Height 96 cm.

STAINLESS
STEEL



A355 494

Saliscendi lusso ultra piatto con asta rettangolare piatta con doccia ad 1 funzione ultrapiatta tutto in ottone.
Altezza: 70 cm.
Deluxe sliding rail Twin extra flat completely in c.p. brass, rectangular extra flat rod, with 1 function hand shower extra flat all in c.p. brass.
Height: 70 cm.



A354 494

Saliscendi e doccia tutto in ottone serie ultrapiatta rettangolare lusso.
Supporto non orientabile.
Altezza: 68 cm.
Deluxe sliding rail and hand shower ultra flat serie, rectangular, all in c.p. brass.
Non-directional support.
Height: 68 cm.



A345 495

Saliscendi completamente in ottone cromato quadro con doccia ad 1 funzione.
Altezza: 70 cm.
C.p. brass square sliding rail set with 1 function handshower.
Height: 70 cm.



A355 495

Saliscendi rettangolare ultraflat con doccia quadrata ad 1 funzione, tutto in ottone cromato.
Altezza: 70 cm.
Ultraflat rectangular sliding rail and 1 function squared handshower, all in c.p. brass.
Height: 70 cm.



A335 434

Saliscendi cromato con asta tonda in ABS cromato e doccia anticalcare a 4 funzioni con getto idromassaggio, getti in silicone.
Altezza: 60 cm.
C.p. ABS sliding rail set with round rod and anti-limestone with silicon jets, hydromassage 4 functions handshower
Height: 60 cm.



A335 430

Saliscendi cromato con asta tonda in ABS cromato e doccia anticalcare.
Altezza: 60 cm.
C.p. ABS sliding rail set with round rod and ABS anti-limestone handshower.
Height: 60 cm.



A352 452

Kit saliscendi con doccia ad 1 funzione.
Altezza: 87 cm.
Sliding rail set with 1 function handshower.
Height: 87 cm.



Saliscendi completamente in ottone cromato con supporto regolabile doccia cilindrica in ottone cromato.
Sliding rail set all in C.P. brass adjustable support with handshower completely in brass.

A340 435 Saliscendi 60 cm.
Sliding rail 60 cm.

A394 435 Saliscendi 90 cm.
Sliding rail 90 cm.



Saliscendi Revival.
Revival sliding rail.

A308 404 cm 60 con asta tonda Ø 25 mm e doccia completamente in ottone cromato.
round rod Ø 25 mm length cm 60 with handshower completely in CP brass.

A398 404 cm 90 con asta tonda Ø 25 mm e doccia completamente in ottone cromato.
round rod Ø 25 mm length cm 90 with handshower completely in CP brass.

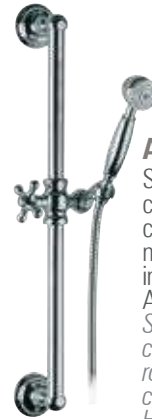

A308 401 Saliscendi Revival completamente in ottone cromato con asta tonda Ø 25 mm e doccia completamente in ottone cromato.
Altezza: 60 cm.
Sliding rail Revival range completely in CP brass, round rod Ø mm 25 with handshower completely in CP brass.
Height: 60 cm.



A388 477 Saliscendi cromato con asta minimale ovale dritta, doccia cromata a 4 funzioni, pulsante per cambio getti, anticalcare e flessibile conico in ottone cromato cm 150 Art. A505X150.
Altezza: 65 cm.
C.p. sliding rail set with c.p. handshower 4 functions, with button to change the jets, anti-limestone and conical shower flexible in c.p. brass cm 150 Art. A505X150.
Height: 65 cm.



A388 3CP Saliscendi cromato con asta minimale ovale dritta e doccia cromata a 4 funzioni con pulsante per il cambio dell'intensità del getto, con getti anticalcare in silicone.
Altezza: 65 cm.
C.p. sliding rail set with minimal oval rod and c.p. handshower 4 functions with button to change the intensity of the jet, anti-limestone with silicone jets.
Height: 65 cm.



A388 488 Saliscendi cromato con asta minimale ovale dritta e doccia cromata a 4 funzioni con pulsante per il cambio dell'intensità del getto, con getti anticalcare in silicone.
Altezza: 65 cm.
C.p. sliding rail set with minimal oval rod and c.p. handshower 4 functions with button to change the intensity of the jet, anti-limestone with silicone jets.
Height: 65 cm.



A320 460 Saliscendi cromato con asta ovale curva e doccia cromata a 4 funzioni con getti anticalcare in silicone.
Altezza: 74 cm.
C.p. sliding rail set with oval arch rod with c.p. handshower 4 functions with anti-limestone silicone jets.
Height: 74 cm.



A361 448 Saliscendi cromato con asta ovale curva e doccia cromata a 4 funzioni con getti anticalcare in silicone.
Altezza: 85 cm.
C.p. sliding rail set with oval arch rod with c.p. handshower 4 functions with anti-limestone silicone jets.
Height: 85 cm.

BOX
INCASSO
BUILT-IN
BOX

WELLNESS
KIT

CROMOTERAPIA
COLOUR
THERAPIE

SOFFIONI
SHOWER
HEAD

PANNELLI
DOCCIA
SHOWER
PANELS

COLONNE
DOCCIA
SHOWER
COLUMN

SALISCENDI
SLIDING RAILS

DOCCETTE
HAND
SHOWERS

OASIS
SHUT-OFF

BOCCHIE
SPOUTS

ACCESSORI
RUBINETTERIA
TAP
ACCESSORIES

SALISCENDI - SLIDING RAILS



A350 478

Saliscendi cromato con asta tonda e doccetta cromata ad 1 funzione con getti anticalcare in silicone.
Altezza: 66 cm.
C.p. sliding rail set with round rod and c.p. handshower 1 function with anti-limestone silicone jets.
Height: 66 cm.



A350 400

Saliscendi cromato con asta tonda e doccetta cromata ad 1 funzione con getti anticalcare in silicone.
Altezza: 66 cm.
C.p. sliding rail set with round rod and c.p. handshower 1 function with anti-limestone silicone jets.
Height: 66 cm.



A350 477

Saliscendi cromato con asta tonda e doccetta cromata a 4 funzioni con pulsante per il cambio dei getti, con getti in silicone anticalcare.
Altezza: 66 cm.
C.p. sliding rail set with round rod and handshower 4 functions with button to change the jets, anti-limestone with silicon jets.
Height: 66 cm.



A300 410

Saliscendi cromato con asta tonda e doccetta cromata ad 1 funzione con getti anticalcare in silicone.
Altezza: 54 cm.
C.p. sliding rail set with c.p. handshower 1 function with anti-limestone silicone jets.
Height: 54 cm.



A300 3F4

Saliscendi con doccetta cromata a 5 funzioni con getti in silicone, anticalcare.
Altezza: 54 cm.
Sliding rail set with c.p. handshower 5 functions, anti-limestone with silicon jets.
Height: 54 cm.



A300 3F5

Saliscendi con doccetta cromata a 5 funzioni con getti in silicone, anticalcare.
Altezza: 54 cm.
Sliding rail set with c.p. handshower 5 functions, anti-limestone with silicon jets.
Height: 54 cm.



A310 3MP

Asta tonda Minimale e doccetta cromata a 4 funzioni con pulsante per il cambio dei getti, con getti in silicone anticalcare.
Altezza: 69 cm.
C.p. sliding rail set with Minimal round rod and handshower 4 functions with button to change the jets, anti-limestone with silicon jets.
Height: 69 cm.



A310 3CP

Asta tonda Minimale e doccetta cromata a 4 funzioni con pulsante per il cambio dei getti, con getti in silicone, anticalcare.
Altezza: 69 cm.
C.p. sliding rail set with Minimal round rod and handshower 4 functions with button to change the jets, anti-limestone with silicon jets.
Height: 69 cm.



A310 440

Saliscendi cromato con asta minimale tonda e doccetta cromata ad 1 funzione con getti anticalcare in silicone.
Altezza: 69 cm.
C.p. sliding rail set with minimal round rod and c.p. handshower 1 function with anti-limestone silicone jets.
Height: 69 cm.

PORTASAPONE - SOAP HOLDER



A300PR

Portasapone cromato per saliscendi con asta Ø 25 mm.
C.P. soap-holder for sliding rail with rod Ø 25 mm.



A300PO

Portasapone cromato per saliscendi con asta ovale curva.
C.P. soap-holder for sliding rail with oval rounded rod.



A300PM

Portasapone cromato per saliscendi con asta Ø 18.
C.P. soap-holder for sliding rail with rod Ø 18.



A350PC

Portasapone cromato economico per saliscendi con asta Ø 18 o Ø 25.
C.P. soap-holder for sliding rail for round rod Ø 18 or Ø 25.



A300P

Portasapone per saliscendi con asta Ø 24 o Ø 25.
Soap-holder for sliding rail with rod Ø 24 or Ø 25



A300PT

Portasapone trasparente economico per saliscendi con asta Ø 18 o Ø 25.
Transparent soap-holder for sliding rail for round rod Ø 18 or Ø 25.

SALISCENDI IN ACCIAIO INOX SPAZZOLATO - BRUSHED STAINLESS STEEL SLIDING RAILS

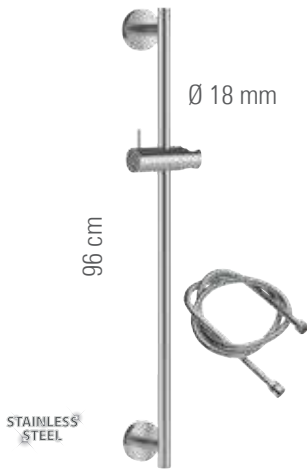

SENZA FLESSIBILE - WITHOUT FLEXIBLE

SSA335

CON FLESSIBILE - WITH FLEXIBLE

SSA335 516

BOX
INCASSO
BUILT-IN
BOX

WELLNESS
KIT

SALISCENDI IN OTTONE CROMATO - C.P. BRASS SLIDING RAILS



SENZA FLESSIBILE
WITHOUT FLEXIBLE

A308

CON FLESSIBILE
WITH FLEXIBLE

A308 505



SENZA FLESSIBILE
WITHOUT FLEXIBLE

A340

CON FLESSIBILE
WITH FLEXIBLE

A340 505



SENZA FLESSIBILE
WITHOUT FLEXIBLE

A352

CON FLESSIBILE
WITH FLEXIBLE

A352 505



SENZA FLESSIBILE
WITHOUT FLEXIBLE

A345

CON FLESSIBILE
WITH FLEXIBLE

A345 505



SENZA FLESSIBILE
WITHOUT FLEXIBLE

A354

CON FLESSIBILE
WITH FLEXIBLE

A354 505



SENZA FLESSIBILE
WITHOUT FLEXIBLE

A355

CON FLESSIBILE
WITH FLEXIBLE

A355 505

CROMOTERAPIA
COLOUR
THERAPIE

SOFFIONI
SHOWER
HEAD

PANNELLI
DOCCIA
SHOWER
PANELS

COLONNE
DOCCIA
SHOWER
COLUMN

SALISCENDI
SLIDING RAILS

SALISCENDI IN ABS - ABS SLIDING RAILS



SENZA FLESSIBILE
WITHOUT FLEXIBLE

A350

CON FLESSIBILE
WITH FLEXIBLE

A350 505

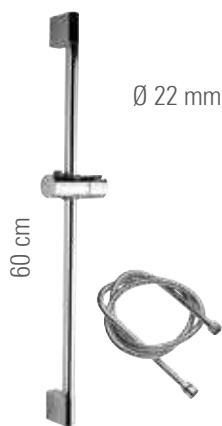

SENZA FLESSIBILE
WITHOUT FLEXIBLE

A301

CON FLESSIBILE
WITH FLEXIBLE

A301 505

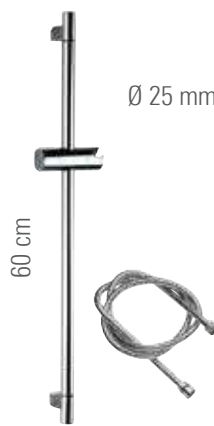

SENZA FLESSIBILE
WITHOUT FLEXIBLE

A310

CON FLESSIBILE
WITH FLEXIBLE

A310 505

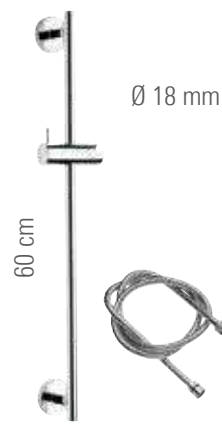

SENZA FLESSIBILE
WITHOUT FLEXIBLE

A335

CON FLESSIBILE
WITH FLEXIBLE

A335 505

DOCCETTE
HAND
SHOWERS

OASIS
SHUT-OFF





BOCCE
SPOUTS

ACCESSORI
RUBINETTERIA
TAP
ACCESSORIES





SALISCENDI - SLIDING RAILS

 <p>Ø 25 mm 60 cm</p>	 <p>ovale 60 cm</p>	 <p>ovale 60 cm</p>	 <p>ovale 60 cm</p>
<p>SENZA FLESSIBILE WITHOUT FLEXIBLE</p> <p>A300</p> <p>CON FLESSIBILE WITH FLEXIBLE</p> <p>A300 505</p>	<p>SENZA FLESSIBILE WITHOUT FLEXIBLE</p> <p>A320</p> <p>CON FLESSIBILE WITH FLEXIBLE</p> <p>A320 505</p>	<p>SENZA FLESSIBILE WITHOUT FLEXIBLE</p> <p>A361</p> <p>CON FLESSIBILE WITH FLEXIBLE</p> <p>A361 505</p>	<p>SENZA FLESSIBILE WITHOUT FLEXIBLE</p> <p>A388</p> <p>CON FLESSIBILE WITH FLEXIBLE</p> <p>A388 505</p>

SALISCENDI 90 cm - 90 cm SLIDING RAILS

 <p>Ø 25 mm 90 cm</p>	 <p>Ø 25 mm 90 cm</p>	 <p>90 cm</p>	 <p>Ø 25 mm 90 cm</p>	 <p>Ø 25 mm 90 cm</p>
<p>SENZA FLESSIBILE WITHOUT FLEXIBLE</p> <p>A391</p> <p>CON FLESSIBILE WITH FLEXIBLE</p> <p>A391 505</p>	<p>SENZA FLESSIBILE WITHOUT FLEXIBLE</p> <p>A390</p> <p>CON FLESSIBILE WITH FLEXIBLE</p> <p>A390 505</p>	<p>SENZA FLESSIBILE WITHOUT FLEXIBLE</p> <p>A392</p> <p>CON FLESSIBILE WITH FLEXIBLE</p> <p>A392 505</p>	<p>SENZA FLESSIBILE WITHOUT FLEXIBLE</p> <p>A398</p> <p>CON FLESSIBILE WITH FLEXIBLE</p> <p>A398 505</p>	<p>SENZA FLESSIBILE WITHOUT FLEXIBLE</p> <p>A394</p> <p>CON FLESSIBILE WITH FLEXIBLE</p> <p>A394 505</p>

FLESSIBILI DOCCIA - SHOWER FLEXIBLE HOSES

 	 						
<p>A506 NC Flessibile per doccia Spyroflex nero-cromo in pvc atossico, con attacco conico. <i>Flexible hose for shower Spyroflex, black and chrome, in atoxic pvc, with conical nut.</i></p>	<p>A506 BC Flessibile per doccia Spyroflex, bianco-cromo, in pvc atossico, con attacco conico. <i>Flexible hose for shower Spyroflex, in atoxic pvc, white-chrome, with conical nut.</i></p>						
<table border="1" style="width: 100%; border-collapse: collapse;"> <tr> <td style="width: 33%;">120</td> <td style="width: 33%;">150</td> <td style="width: 33%;">200</td> </tr> </table>	120	150	200	<table border="1" style="width: 100%; border-collapse: collapse;"> <tr> <td style="width: 33%;">120</td> <td style="width: 33%;">150</td> <td style="width: 33%;">200</td> </tr> </table>	120	150	200
120	150	200					
120	150	200					



Flessibile per doccia
Shower flexible hose

A500

in ottone cromato con attacco a doppia ghiera, tubo in EPDM.
in CP Brass with double nut connection, EPDM rubber inside.



100	120	150	200
-----	-----	-----	-----

A505

in ottone cromato Ø 14 F.F., con attacco conico, tubo in EPDM
in C.P. brass, EPDM rubber inside, Ø 14, with one conical nut.



120	150	200
-----	-----	-----

A505X

in acciaio INOX Ø 14, tubo interno in gomma EPDM, attacco conico, 1/2".
in stainless steel Ø 14, internal in EPDM rubber, one conical nut, 1/2".



120	150	200
-----	-----	-----

**A506**

Flessibile doccia in PVC atossico con piattina cromata, attacco conico.
Flexible hose for shower in atoxic PVC and chrome flat wire, with one conical nut.

120	150	200
-----	-----	-----



Girevole antitorsione
Anti-torsion swivelling

A516 AT

Flessibile per doccia retinato metallizzato in PVC atossico, con attacco conico e sistema girevole ed anti-torsione.
Flexible hose for shower with net working metal colour, in atoxic PVC, with one conical nut and anti-torsion swivelling system.

120	150	200
-----	-----	-----

**A515**

Flessibile per doccia in plastica grigio metallizzato, con attacco conico.
Flexible hose for shower in metallized PVC with conical nut.

120	150	200
-----	-----	-----

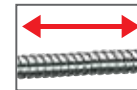

Extendible

**A510**

Flessibile per doccia estensibile a doppia graffatura in ottone cromato Ø 14 F.F., tubo in EPDM, con attacco conico.
Flexible and extendible hose for shower, double clinching in C.P. brass, Ø 14, EPDM rubber internal, with one conical nut.

120	150	200
-----	-----	-----

**A511**

Flessibile per doccia a doppia graffatura in ottone cromato Ø 17 F.F., tubo in EPDM, con attacco conico.
Flexible hose for shower, double clinching in C.P. brass, 17 mm Ø F.F., EPDM rubber inside, with one conical nut.

150	200
-----	-----

**A516**

Flessibile per doccia retinato metallizzato in PVC atossico, con attacco conico.
Flexible hose for shower with net working metal colour, in atoxic PVC, with one conical nut.

120	150	200
-----	-----	-----



Girevole antitorsione
Anti-torsion swivelling

A505 AT

Flessibile per doccia estensibile a doppia graffatura in ottone, con sistema girevole ed anti-torsione, Ø 15 mm, tubo in EPDM con attacco conico.
Flexible and extendible hose for shower, in C.P. brass, Anti-torsion swivelling system, Ø 15 mm, EPDM rubber inside with one conical nut.

120	150	200
-----	-----	-----

BOX
INCASSO
BUILT-IN
BOX

WELLNESS
KIT

CROMOTERAPIA
COLOUR
THERAPIE

SOFFIONI
SHOWER
HEAD

PANNELLI
DOCCIA
SHOWER
PANELS

COLONNE
DOCCIA
SHOWER
COLUMN

SALISCENDI
SLIDING
RAILS

DOCCETTE
HAND
SHOWERS

OASIS
SHUT-OFF

BOCCHIE
SPOUTS

ACCESSORI
RUBINETTERIA
TAP
ACCESSORIES



DOCCETTE HAND SHOWERS

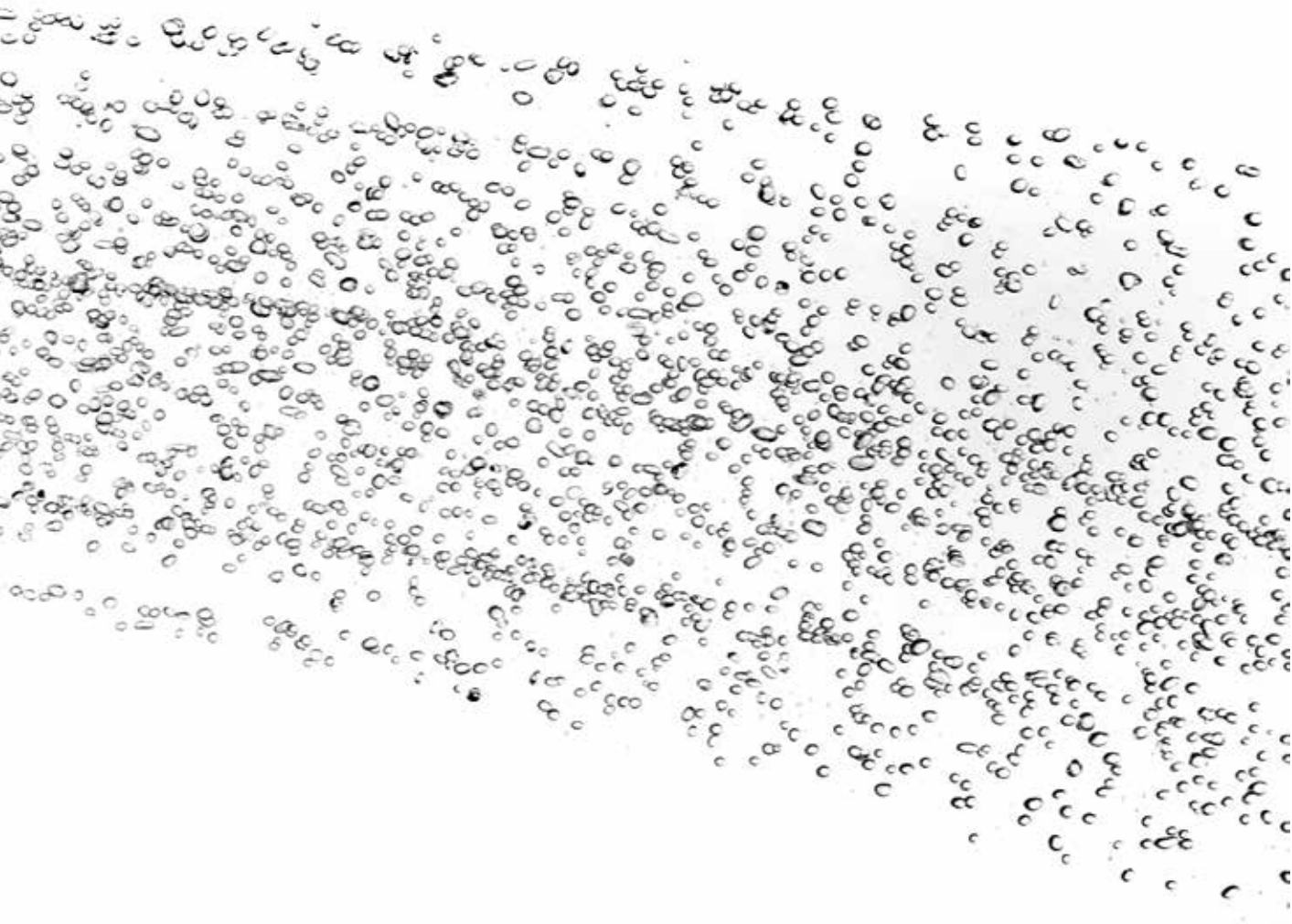

WELLNESS

BOX
INCASSO
BUILT-IN
BOX

WELLNESS
KIT

CROMOTERAPIA
COLOUR
THERAPIE

SOFFIONI
SHOWER
HEAD

PANNELLI
DOCCIA
SHOWER
PANELS

COLONNE
DOCCIA
SHOWER
COLUMN

SALISCENDI
SLIDING
RAILS

DOCCETTE
HAND
SHOWERS

OASIS
SHUT-OFF

BOCCE
SPOUTS

ACCESSORI
RUBINETTERIA
TAP
ACCESSORIES

VARIANTI FLESSIBILI - FLEXIBLE OPTIONS

Per richiedere la variante flessibile aggiungere la lettera al codice articolo.

To request a different flexible, add the letter to the article number.

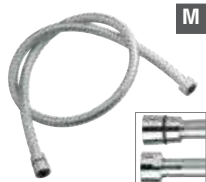

M

A516150

Flessibile doccia retinato realizzato in PVC atossico con attacco conico.
Flexible hose for shower with net working metal colour in atoxic PVC with one conical nut.



C

A506150

Flessibile doccia in PVC atossico con piattina cromata, attacco conico.
Flexible hose for shower in atoxic PVC and chrome flat wire, with one conical nut.



A547Q3CP

Set doccia quadrato composto da: presa acqua con supporto lusso in ottone cromato, doccetta cromata a 4 funzioni, con pulsante per cambio dei getti, anticalcare con getti in silicone e flessibile 150 cm.
Squared shower set composed of: c.p. water punch and shower holder in brass, handshower 4 functions with button to change the jets, anti-limestone with silicon jets and 150 cm flexible hose.



SSA546435

Set doccia minimale in acciaio INOX spazzolato composto da: presa acqua con supporto lusso, doccetta ad 1 funzione e flessibile in pvc color grigio acciaio 150 cm.
Minimal brushed stainless steel shower set composed of: water punch shower holder, and 1 function handshower and 150 cm pvc steel grey colour flexible hose.



A546435

Set doccia Minimale composto da: presa acqua con supporto lusso in ottone cromato, doccetta in ottone cromato e flessibile 150 cm.
Minimal shower set composed of: c.p. water punch and shower holder in brass, c.p. brass handshower and 150 cm flexible hose.



A547Q495

Set doccia quadrato composto da: presa acqua con supporto lusso in ottone cromato, doccetta in ottone cromato e flessibile 150 cm.
Squared shower set composed of: c.p. water punch and shower holder in brass, c.p. brass handshower and 150 cm flexible hose.



A546430

Set doccia Minimale composto da: presa acqua con supporto lusso in ottone cromato, doccetta in ABS cromato, anticalcare con getti in silicone e flessibile 150 cm.
Minimal shower set composed of: c.p. water punch and shower holder in brass, c.p. ABS handshower anti-limestone with silicon jets and 150 cm flexible hose.



A547Q492

Set doccia quadrato composto da: presa acqua con supporto lusso in ottone cromato, doccetta cromata anticalcare con getti in silicone e flessibile 150 cm.
Squared shower set composed of: c.p. water punch and shower holder in brass, handshower anti-limestone with silicon jets and 150 cm flexible hose.



A546436

Set doccia composto da: presa acqua con supporto lusso in ottone cromato, doccetta cromata, anticalcare con getti in silicone e flessibile 150 cm.
Shower set composed of: c.p. water punch and shower holder in brass, handshower anti-limestone with silicon jets and 150 cm flexible hose.



A5463F4

Set doccia composto da: presa acqua con supporto lusso in ottone cromato, doccetta cromata 5 funzioni, anticalcare con getti in silicone e flessibile 150 cm.
Shower set composed of: c.p. water punch and shower holder in brass, 5 functions handshower anti-limestone with silicon jets and 150 cm flexible hose.



A5463MP

Set doccia composto da: presa acqua con supporto lusso in ottone cromato, doccetta cromata a 4 funzioni, con pulsante per cambio dei getti, anticalcare con getti in silicone e flessibile 150 cm.
Shower set composed of: c.p. water punch and shower holder in brass, handshower 4 functions with button to change the jets, anti-limestone with silicon jets and 150 cm flexible hose.



A546434

Set doccia composto da: presa acqua con supporto lusso in ottone cromato, doccetta cromata 4 funzioni, idromassaggio, anticalcare con getti in silicone e flessibile 150 cm.
Shower set composed of: c.p. water punch and shower holder in brass, 4 functions handshower anti-limestone with silicon jets, hydromassage, and 150 cm flexible hose.

DOCCETTE - HAND SHOWERS



Doccetta cromata a 3 funzioni, pulsante per il cambio dei getti, getti in silicone con anti-calcare.
C.p. ABS 3 functions handshower, with button to change jets, anti-limestone with silicon jets.

SENZA SCATOLA - WITHOUT BOX

A443V3

CON SCATOLA - WITH BOX

A443V3S

Doccetta cromata a 4 funzioni, getti in silicone con anti-calcare.
C.p. ABS 4 functions handshower, anti-limestone with silicon jets.

SENZA SCATOLA - WITHOUT BOX

A448F5

CON SCATOLA - WITH BOX

A448F5S

Doccetta cromata a 4 funzioni, pulsante per il cambio dei getti, getti in silicone con anti-calcare.
C.p. ABS 4 functions handshower, with button to change jets, anti-limestone with silicon jets.

SENZA SCATOLA - WITHOUT BOX

A443MP

CON SCATOLA - WITH BOX

A443MPS

Doccetta cromata a 4 funzioni, pulsante per il cambio dei getti, getti in silicone con anti-calcare.
C.p. ABS 4 functions handshower, with button to change jets, anti-limestone with silicon jets.

SENZA SCATOLA - WITHOUT BOX

A477

CON SCATOLA - WITH BOX

A477S

Doccetta "Miss" in ottone cromato ad 1 funzione.
C.p. brass "Miss" handshower, 1 function.

SENZA SCATOLA - WITHOUT BOX

A401

CON SCATOLA - WITH BOX

A401S

Doccetta "Revival" in ottone cromato ad 1 funzione.
C.p. brass "Revival" handshower, 1 function.

SENZA SCATOLA - WITHOUT BOX

A404

CON SCATOLA - WITH BOX

A404S

Doccetta rettangolare minimale ultrapiatta, in acciaio INOX ad 1 funzione.
Extraflat minimal rectangular hand shower, in stainless steel, 1 function.

SENZA SCATOLA - WITHOUT BOX

SSA494

CON SCATOLA - WITH BOX

SSA494S

Doccetta rettangolare minimale serie Twin ultrapiatta, in ottone cromato ad 1 funzione.
Extraflat minimal rectangular hand shower Twin, in chrome plated brass, 1 function.

SENZA SCATOLA - WITHOUT BOX

A494

CON SCATOLA - WITH BOX

A494S

Doccetta quadrata, completamente in ottone ad una funzione in ottone cromato.
Square hand shower completely in CP brass, one function.

SENZA SCATOLA - WITHOUT BOX

A495

CON SCATOLA - WITH BOX

A495S

Doccetta minimale completamente in ottone cromato ad una funzione.
Minimal hand shower, completely in C.P. brass, one function.

SENZA SCATOLA - WITHOUT BOX

A435

CON SCATOLA - WITH BOX

A435S

Doccetta serie Diva ad una funzione in ottone cromato.
Diva hand shower, one function, in chrome plated brass.

SENZA SCATOLA - WITHOUT BOX

A452

CON SCATOLA - WITH BOX

A452S

Doccetta ad una funzione in acciaio INOX.
One function hand shower, in stainless steel.

SENZA SCATOLA - WITHOUT BOX

SSA435

CON SCATOLA - WITH BOX

SSA435S

Doccetta minimale arcuata in ABS cromato ad 1 funzione con getti anticalcare.
Minimal arch hand shower in c.p. ABS, 1 function, with silicon jets.

SENZA SCATOLA - WITHOUT BOX

A436

CON SCATOLA - WITH BOX

A436S

Doccetta quadrata in ABS cromato ad 1 funzione con getti anticalcare.
Squared hand shower in c.p. ABS, 1 function, with silicon jets.

SENZA SCATOLA - WITHOUT BOX

A492

CON SCATOLA - WITH BOX

A492SBOX
INCASSO
BUILT-IN
BOXWELLNESS
KITCROMOTERAPIA
COLOUR
THERAPIESOFFIONI
SHOWER
HEADPANNELLI
DOCCIA
SHOWER
PANELSCOLONNE
DOCCIA
SHOWER
COLUMNSALISCENDI
SLIDING
RAILSDOCCETTE
HAND
SHOWERSOASIS
SHUT-OFFBOCCHE
SPOUTSACCESSORI
RUBINETTERIA
TAP
ACCESSORIES

DOCCHETTE - HAND SHOWERS



Doccetta quadrata anticalcare ad 1 funzione.
Square handshower, anti-limestone, 1 function.

SENZA SCATOLA - WITHOUT BOX

A490

CON SCATOLA - WITH BOX

A490S



Doccia minimale anticalcare con getti in silicone, cromata ad 1 funzione.
C.P. minimal hand shower anti-limestone with jets in silicone, 1 function.

SENZA SCATOLA - WITHOUT BOX

A430

CON SCATOLA - WITH BOX

A430S



Doccetta cromata a 5 funzioni con getti in silicone, anticalcare.
C.p. hand shower 5 functions, anti-limestone with silicone jets.

SENZA SCATOLA - WITHOUT BOX

A443F4

CON SCATOLA - WITH BOX

A443F4S



Doccetta cromata a 5 funzioni con getti in silicone, anticalcare.
C.p. hand shower 5 functions, anti-limestone with silicone jets.

SENZA SCATOLA - WITHOUT BOX

A443F5

CON SCATOLA - WITH BOX

A443F5S



Doccetta a disco con getto a cascata, 2 funzioni anticalcare.
Anti-limestone disc hand shower with cascade jet, 2 functions.

SENZA SCATOLA - WITHOUT BOX

A444

CON SCATOLA - WITH BOX

A444S



Doccetta a disco 4 funzioni idromassaggio anticalcare.
Anti-limestone hydromassage hand shower 4 functions.

SENZA SCATOLA - WITHOUT BOX

A448

CON SCATOLA - WITH BOX

A448S

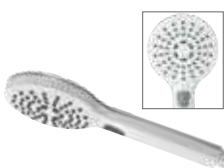

Doccetta cromata a 3 funzioni con pulsante per il cambio dei getti e getti in silicone, anticalcare.
C.p. hand shower 3 functions with button to change the jets, anti-limestone with silicone jets.

SENZA SCATOLA - WITHOUT BOX

A442WP

CON SCATOLA - WITH BOX

A442WPS



Doccetta cromata a 3 funzioni con getti in silicone ed anticalcare.
C.p. hand shower 3 functions, anti-limestone with silicone jets.

SENZA SCATOLA - WITHOUT BOX

A442W3

CON SCATOLA - WITH BOX

A442W3S



Doccetta cromata ad 1 funzione con getti in silicone ed anticalcare.
C.p. hand shower 1 function, anti-limestone with silicone jets.

SENZA SCATOLA - WITHOUT BOX

A442W1

CON SCATOLA - WITH BOX

A442W1S



Doccetta cromata a 4 funzioni con pulsante per il cambio dell'intensità del getto, con getti anticalcare in silicone.
C.p. hand shower 4 functions with button to change the intensity of the jet, anti-limestone with silicone jets.

SENZA SCATOLA - WITHOUT BOX

A443CP

CON SCATOLA - WITH BOX

A443CPS



Doccia minimale anticalcare con 4 funzioni, getti in silicone, cromata.
C.P. minimal hand shower anti-limestone with 4 functions in silicone jets.

SENZA SCATOLA - WITHOUT BOX

A434

CON SCATOLA - WITH BOX

A434S



Doccia minimale anticalcare con 2 funzioni, getti in silicone, cromata.
C.P. minimal hand shower anti-limestone with 2 functions and jets in silicone.

SENZA SCATOLA - WITHOUT BOX

A433

CON SCATOLA - WITH BOX

A433S



Doccetta minimale completamente in ottone cromato ad una funzione.
Minimal hand shower completely in c.p. brass, one function.

SENZA SCATOLA - WITHOUT BOX

A485

CON SCATOLA - WITH BOX

A485S



Doccetta a disco 3 funzioni anticalcare.
Anti-limestone hand shower 3 functions.

SENZA SCATOLA - WITHOUT BOX

A499

CON SCATOLA - WITH BOX

A499S



Doccia cromata minimale ovale con getti in silicone anticalcare, ad una funzione.
C.P. minimal oval hand shower in silicone jets antilimestone, one function.

SENZA SCATOLA - WITHOUT BOX

A488

CON SCATOLA - WITH BOX

A488S



Doccia cromata con getti in silicone anticalcare, 1 funzione.
C.P. hand shower anti-limestone with jets in silicone, 1 function.

SENZA SCATOLA - WITHOUT BOX

A400

CON SCATOLA - WITH BOX

A400S



Doccia idromassaggio anticalcare 4 funzioni cromata.
C.P. hand shower 4 functions, hydromassage, anti-limestone.

SENZA SCATOLA - WITHOUT BOX

A460

CON SCATOLA - WITH BOX

A460S



Doccetta idromassaggio anticalcare ad una funzione.
CP hand shower anti-limestone, one function.

SENZA SCATOLA - WITHOUT BOX

A478

CON SCATOLA - WITH BOX

A478S



Doccia cromata-satinata con getti in silicone anticalcare, ad una funzione.
Chrome-satin hand shower anti-limestone with jets in silicone, one function.

SENZA SCATOLA - WITHOUT BOX

A440

CON SCATOLA - WITH BOX

A440S



Doccia cromata, con getti in silicone anticalcare, ad una funzione.
C.P. hand shower, with jets in silicone, anti-limestone, one function.

SENZA SCATOLA - WITHOUT BOX

A441

CON SCATOLA - WITH BOX

A441S



Doccia cromata anticalcare, 1 funzione.
C.P. hand shower anti-limestone, 1 function.

SENZA SCATOLA - WITHOUT BOX

A450

CON SCATOLA - WITH BOX

A450S



Doccetta idromassaggio autopulente, anticalcare 4 funzioni.
CP hydromassage hand shower, 4 functions, self-cleaning, anti-limestone.

SENZA SCATOLA - WITHOUT BOX

A445

CON SCATOLA - WITH BOX

A445S



Doccetta autopulente, anticalcare 3 funzioni.
CP hand shower, 3 functions, self-cleaning, anti-limestone.

SENZA SCATOLA - WITHOUT BOX

A476

CON SCATOLA - WITH BOX

A476S



Doccetta idromassaggio autopulente, anticalcare 3 funzioni.
CP hydromassage hand shower, 3 functions, self-cleaning, anti-limestone.

SENZA SCATOLA - WITHOUT BOX

A410

CON SCATOLA - WITH BOX

A410S



Doccetta idromassaggio anticalcare 1 funzione.
CP hydromassage hand shower, 1 function, anti-limestone.

SENZA SCATOLA - WITHOUT BOX

A475

CON SCATOLA - WITH BOX

A475S



Doccetta satinata, anticalcare con getti in silicone, 1 funzione.
Satin hand shower with jets in silicone, anti-limestone, 1 function.

SENZA SCATOLA - WITHOUT BOX

A405

CON SCATOLA - WITH BOX

A405S



Doccetta estraibile cromata per monoforo lavello, 2 funzioni.
Pull-out hand shower for one-hole sink mixer, 2 functions.

SENZA SCATOLA - WITHOUT BOX

A413

CON SCATOLA - WITH BOX

A413S

BOX
INCASSO
BUILT-IN
BOX

WELLNESS
KIT

CROMOTERAPIA
COLOUR
THERAPIE

SOFFIONI
SHOWER
HEAD

PANNELLI
DOCCIA
SHOWER
PANELS

COLONNE
DOCCIA
SHOWER
COLUMN

SLISCENDI
SLIDING
RAILS

DOCCETTE
HAND
SHOWERS

OASIS
SHUT-OFF

BOCCHE
SPOUTS

ACCESSORI
RUBINETTERIA
TAP
ACCESSORIES

SUPPORTI DOCCIA - SHOWER HOLDER



A549

Rubinetto d'arresto squadrato, con supporto doccia in ottone cromato e presa acqua, per flessibile con attacco conico.
C.p. brass squared angle valve with shower holder and water punch, for conical nut flexibles.



A548

Rubinetto d'arresto minimale tondo, con supporto doccia in ottone cromato e presa acqua, per flessibile con attacco conico.
C.p. brass round minimalist angle valve with shower holder and water punch, for conical nut flexibles.



SSA546

Supporto lusso con presa acqua minimale in acciaio INOX spazzolato per incasso, per flessibile con attacco conico.
Minimal brushed stainless steel shower holder water punch, for built-in and for conical nut flexible.



A546

Supporto lusso con presa acqua minimale in ottone cromato per incasso, per flessibile con attacco conico.
Minimal c.p. brass shower holder water punch, for built-in and for conical nut flexible.



A546X

Supporto lusso con presa acqua minimale in ottone cromato per incasso con piastra ultra flat, per flessibile con attacco conico.
Minimal c.p. brass shower holder water punch with ultra flat flange, for built-in and for conical nut flexible.



A547Q

Supporto lusso con presa acqua quadrato in ottone cromato per incasso, per flessibile con attacco conico.
Squared c.p. brass shower holder water punch, for built-in and for conical nut flexible.



A547

Supporto snodato lusso quadrato in ottone cromato per incasso, per flessibile con attacco conico.
CP brass adjustable shower holder square, for built-in and for conical nut flexible.



A544

Supporto snodato per doccia in ottone cromato con presa acqua.
CP brass adjustable shower holder with water punch connector.



A532

Supporto snodato a braccio minimalista in ABS cromato per flessibile con attacco conico.
Adjustable minimal shower holder in CP ABS, for conical nut flexible.



A534

Supporto snodato a braccio quadrato in ABS cromato per flessibile con attacco conico.
Adjustable squared shower holder in CP ABS, for conical nut flexible.



A530

Supporto snodato per doccia in ottone cromato.
CP brass adjustable shower holder.

**SSA537**

Supporto fisso minimale in acciaio INOX spazzolato per flessibile con attacco conico.
Minimal shower holder brushed stainless steel, for conical nut flexible.

STAINLESS
STEEL**A536**

Supporto fisso quadrato in ottone cromato per flessibile con attacco conico.
Shower holder square in CP brass, for conical nut flexible.

**A5350T**

Supporto fisso in ottone cromato per flessibile con attacco conico.
Shower holder in CP brass, for conical nut flexible.

**A537**

Supporto fisso in ottone cromato per flessibile con attacco conico.
Shower holder in CP brass, for conical nut flexible.

**A540**

Supporto fisso in ABS cromato.
C.P. plastic adjustable shower holder.

**A535**

Supporto fisso in ABS cromato per flessibile con attacco conico.
Shower holder in CP ABS, for conical nut flexible.

**A5353P**

Supporto fisso a 3 posizioni in ABS cromato per flessibile con attacco conico.
Shower holder in CP ABS, 3 positions for conical nut flexible.

**A525**

Attacco presa acqua da 1/2 tipo rotondo pesante.
C.P. brass wall connector, round heavy type 1/2 for shower.

**A521**

Attacco presa acqua da 1/2, tipo quadrato, pesante.
C.p. brass wall water punch connector, squared and heavy type, 1/2, for shower.

**SSA520**

Attacco presa acqua da 1/2 minimale in acciaio INOX.
Stainless steel wall connector, minimal type 1/2 for shower.

STAINLESS
STEEL**A520**

Angolo 1/2Mx1/2M in ottone cromato con rosetta scorrevole.
C.P. brass angle 1/2Mx1/2M with C.P. brass sliding flange.

BOX
INCASSO
BUILT-IN
BOXWELLNESS
KITCROMOTERAPIA
COLOUR
THERAPIESOFFIONI
SHOWER
HEADPANNELLI
DOCCIA
SHOWER
PANELSCOLONNE
DOCCIA
SHOWER
COLUMNSALISCENDI
SLIDING RAILSDOCCETTE
HAND
SHOWERSOASIS
SHUT-OFFBOCCHE
SPOUTSACCESSORI
RUBINETTERIA
TAP
ACCESSORIES



SHUT-OFF



BOX
INCASSO
BUILT-IN
BOX

WELLNESS
KIT

CROMOTERAPIA
COLOUR
THERAPIE

SOFFIONI
SHOWER
HEAD

PANNELLI
DOCCIA
SHOWER
PANELS

COLONNE
DOCCIA
SHOWER
COLUMN

SALISCENDI
SLIDING
RAILS

DOCCETTE
HAND
SHOWERS

OASIS
SHUT-OFF

BOCCH
SPOUTS

ACCESSORI
RUBINETTERIA
TAP
ACCESSORIES



MISCELATORE INCASSO PER SHUT-OFF - BUILT-IN SHUT-OFF MIXER



SK646
Miscelatore incasso per shut-off.
Built-in shut-off mixer.



DV646
Miscelatore incasso per shut-off.
Built-in shut-off mixer.



OX23646
Miscelatore incasso per shut-off.
Built-in shut-off mixer.



S20646
Miscelatore incasso per shut-off.
Built-in shut-off mixer.



OM646
Miscelatore incasso per shut-off.
Built-in shut-off mixer.

SHUT-OFF PROGRESSIVO - PROGRESSIVE SHUT-OFF



S20644 4DC
Miscelatore shut-off con cartuccia progressiva, apertura su acqua fredda e passaggio ad acqua calda tramite rotazione di maniglia unica, comprensivo di doccetta shut-off art. 1004DC e flessibile doccia cm 120.
Shut-off mixer with progressive cartridge, opening with cold water, switching on hot water by rotating one single handle including shut-off art. 1004DC and shower flexible 120 cm.



SHUT-OFF TERMOSTATICO - THERMOSTATIC SHUT-OFF



ST20642 4DC
Miscelatore incasso termostatico per shut-off con doccetta shut-off, supporto doccia, presa acqua.
Thermostatic built-in shut-off mixer set with shut-off, shower holder, water punch.





SHUT-OFF



Miscelatore incasso per shut-off con supporto doccia e presa acqua.
Built-in shut-off mixer set with shower holder and water punch.

TK6454DC Con doccetta shut-off e flessibile 120 cm.
With shut-off and flexible hose 120 cm.

TK645H Senza kit doccia.
Without shower set.



Miscelatore incasso per shut-off con supporto doccia e presa acqua.
Built-in shut-off mixer set with shower holder and water punch.

FU6454DC Con doccetta shut-off e flessibile 120 cm.
With shut-off and flexible hose 120 cm.

FU645H Senza kit doccia.
Without shower set.



Miscelatore incasso per shut-off serie Omega su piastra in ottone cromato, supporto doccia e presa acqua.
Omega model built-in shower mixer all in c.p. brass with shower holder and water punch.

OM645 comprensivo di doccetta shut-off art. 1000DC, supporto doccia-presa acqua, tutto in ottone cromato e flessibile doccia cm 120.
including shut-off art. 1000DC, shower holder-water punch on flange, all in c.p. brass and shower flexible cm 120.

OM645H senza kit shut-off.
without shut-off set.



Miscelatore incasso per shut-off su piastra in ottone cromato, supporto doccia e presa acqua.
Built-in shower mixer all in c.p. brass with shower holder and water punch.

SR645 comprensivo di doccetta shut-off art. 1000DC, supporto doccia-presa acqua, tutto in ottone cromato e flessibile doccia cm 120.
including shut-off art. 1000DC, shower holder-water punch on flange, all in c.p. brass and shower flexible cm 120.

SR645H senza kit shut-off.
without shut-off set.

BOX
INCASSO
BUILT-IN
BOX

WELLNESS
KIT

CROMOTERAPIA
COLOUR
THERAPIE

SOFFIONI
SHOWER
HEAD

PANNELLI
DOCCIA
SHOWER
PANELS

COLONNE
DOCCIA
SHOWER
COLUMN

SALISCENDI
SLIDING
RAILS

DOCCETTE
HAND
SHOWERS

OASIS
SHUT-OFF

BOCCHIE
SPOUTS

ACCESSORI
RUBINETTERIA
TAP
ACCESSORIES

OASIS - SHUT-OFF



Miscelatore incasso per shut-off con supporto doccia e presa acqua.
Built-in shower mixer with shower holder and water punch.

S20645S

comprensivo di: doccetta shut-off art. 1000DC, supporto doccia-presa acqua, tutto in ottone cromato e flessibile doccia cm 120.

including: shut-off art. 1000DC, shower holder-water punch on flange, all in c.p. brass and shower flexible cm 120.

S20645SH

Senza kit doccia.
Without shower set.



Miscelatore incasso per shut-off con supporto doccia e presa acqua.
Built-in shower mixer with shower holder and water punch.

TA645

comprensivo di doccetta shut-off art. 1000DC, supporto doccia-presa acqua, tutto in ottone cromato e flessibile doccia cm 120.

including: shut-off art. 1000DC, shower holder-water punch on flange, all in c.p. brass and shower flexible cm 120.

TA645H

Senza kit doccia.
Without shower set.



SRE645LT8

Miscelatore incasso per shut-off con doccetta shut-off, supporto doccia, presa acqua.
Built-in shut-off mixer set shut-off, shower holder, water punch.



8 L / Min.



OME645LT8

Miscelatore incasso per shut-off con doccetta shut-off, supporto doccia, presa acqua.
Built-in shut-off mixer set shut-off, shower holder, water punch.



8 L / Min.



DV642

Miscelatore incasso per shut-off con doccetta shut-off, supporto doccia, presa acqua.
Built-in shut-off mixer set shut-off, shower holder, water punch.



SP642

Miscelatore incasso per shut-off con doccetta shut-off, supporto doccia, presa acqua.
Built-in shut-off mixer set shut-off, shower holder, water punch.



S20642

Miscelatore incasso per shut-off con doccetta shut-off, supporto doccia, presa acqua.
Built-in shut-off mixer set with shut-off, shower holder, water punch.



BOX
INCASSO
BUILT-IN
BOX

WELLNESS
KIT

CROMOTERAPIA
COLOUR
THERAPIE

SOFFIONI
SHOWER
HEAD

PANNELLI
DOCCIA
SHOWER
PANELS

COLONNE
DOCCIA
SHOWER
COLUMN

SLISCENDI
SLIDING
RAILS

DOCCETTE
HAND
SHOWERS

OASIS
SHUT-OFF

BOCCHIE
SPOUTS

ACCESSORI
RUBINETTERIA
TAP
ACCESSORIES



FU6424DC

Miscelatore incasso per shut-off con doccetta shut-off, supporto doccia e presa acqua.
Built-in shut-off mixer set, with shut-off, shower holder and water punch.



OM642

Miscelatore incasso per shut-off con doccetta shut-off, supporto doccia, presa acqua.
Built-in shut-off mixer set shut-off, shower holder, water punch.



SK642

Miscelatore incasso per shut-off con doccetta shut-off, supporto doccia, presa acqua.
Built-in shut-off mixer set with shut-off, shower holder, water punch.



OX23642

Miscelatore incasso per shut-off con doccetta shut-off, supporto doccia, presa acqua.
Built-in shut-off mixer set shut-off, shower holder, water punch.



SR642

Miscelatore incasso per shut-off con doccetta shut-off, supporto doccia, presa acqua.
Built-in shut-off mixer set shut-off, shower holder, water punch.



TK6424DC

Miscelatore incasso per shut-off con doccetta shut-off, supporto doccia e presa acqua.
Built-in shut-off mixer set with shut-off, shower holder and water punch.



1015

Set composto da: doccia a pulsante in ottone cromato, flessibile con attacco conico cm 120 rubinetto d'arresto con supporto doccia in ottone cromato.
Set composed of: c.p. brass shut-off handshower, flexible cm 120, c.p. brass round angle valve with shower holder.



1025

Set composto da: doccia a pulsante quadrata in ottone cromato, flessibile con attacco conico cm 120 rubinetto d'arresto con supporto doccia in ottone cromato.
Set composed of: squared c.p. brass shut-off handshower, flexible cm 120, c.p. brass squared angle valve with shower holder.



1015Z

Set composto da: doccia a pulsante in ottone cromato con impugnatura zigrinata, flessibile con attacco conico cm 120 rubinetto d'arresto con supporto doccia in ottone cromato.
Set composed of: c.p. brass shut-off handshower with knurled handgrip, flexible cm 120, c.p. brass round angle valve with shower holder.



1015EU

Set composto da: doccia a pulsante in ABS, flessibile con attacco conico cm 120 rubinetto d'arresto con supporto doccia in ottone cromato.
Set composed of: c.p. ABS shut-off handshower, flexible cm 120, c.p. brass round angle valve with shower holder.



1027

Set composto da: doccia a pulsante in ottone cromato (con chiave pulizia aeratore), flessibile conico 120 cm, flessibile con attacco conico cm 120 rubinetto d'arresto con supporto doccia in ottone cromato.
Set composed of: c.p. brass shut-off handshower (with cleaning aerator key), conical flex, flexible cm 120, c.p. brass round angle valve with shower holder.



1019

Set composto da: doccia a pulsante in ottone cromato, flessibile con attacco conico cm 120 rubinetto d'arresto con supporto doccia in ottone cromato.
Set composed of: c.p. brass shut-off handshower, flexible cm 120, c.p. brass round angle valve with shower holder.

**S20605SH**

Miscelatore monocomando lavabo con doccia shut-off e scarico click-clack con troppo pieno.
Single-lever basin mixer with shut-off handshower and click-clack pop-up waste with overflow.

**SK605SH**

Miscelatore monocomando lavabo con doccia shut-off e scarico click-clack con troppo pieno.
Single-lever basin mixer with shut-off handshower and click-clack pop-up waste with overflow.

**OM605SH4DC**

Miscelatore monocomando lavabo con doccia shut-off e scarico click-clack con troppo pieno.
Single-lever basin mixer with shut-off handshower and click-clack pop-up waste with overflow.

**SR605SH4DC**

Miscelatore monocomando lavabo con doccia shut-off e scarico click-clack con troppo pieno.
Single-lever basin mixer with shut-off handshower and click-clack pop-up waste with overflow.

**MT22631ADP**

Set composto da: doccia a pulsante, flessibile conico 120 cm, miscelatore doccia e gancio in ABS cromato.
Set composed of: shut-off handshower, flexible hose 120 cm, shower mixer and c.p. ABS hook.

**1031**

Set "Oasis", composto da: doccia a pulsante, flessibile conico 120 cm, miscelatore doccia e supporto in ottone cromato.
"Oasis" set composed of: shut-off handshower, flexible 120 cm, shower mixer and c.p. brass shower holder.

**1031Z**

Set "Oasis", composto da: doccia a pulsante in ottone cromato con impugnatura zigrinata, flessibile conico 120 cm, miscelatore doccia e supporto in ottone cromato.
"Oasis" set composed of: c.p. brass shut-off handshower with knurled handgrip, flexible 120 cm, shower mixer and c.p. brass shower holder.



Miscelatore monocomando esterno doccia, interasse 100 mm.
Wall mounted single lever shower mixer, interaxis 100 mm.

OM22611ADP

comprensivo di doccetta shut-off in ABS cromato flessibile conico in ottone cromato 120 cm e gancio in ABS cromato.

including: shut-off hand shower, conical flexible in c.p. brass cm 120 and c.p. ABS hook.



Miscelatore monocomando esterno doccia, interasse 100 mm.
Wall mounted single lever shower mixer, interaxis 100 mm.

SR22611ADP

comprensivo di doccia a pulsante, flessibile conico in ottone cromato 120 cm e gancio in ABS cromato.

including: shut-off handshower, conical flexible in c.p. brass cm 120, and c.p. ABS hook.

OM22611

Senza kit doccia.
Without shower set.

SR22611

Senza kit doccia.
Without shower set.

BOX
INCASSO
BUILT-IN
BOX

WELLNESS
KIT

CROMOTERAPIA
COLOUR
THERAPIE

SOFFIONI
SHOWER
HEAD

PANNELLI
DOCCIA
SHOWER
PANELS

COLONNE
DOCCIA
SHOWER
COLUMN

SALISCENDI
SLIDING
RAILS

DOCCETTE
HAND
SHOWERS

OASIS
SHUT-OFF

BOCCHE
SPOUTS

ACCESSORI
RUBINETTERIA
TAP
ACCESSORIES

OASIS - SHUT-OFF



1000

Set "Oasis" composto da: doccia a pulsante art. 1000DC, flex. conico cm 120 rubinetto ad angolo con vitone ceramico e supporto in ottone cromato.

"Oasis" set composed of: shut-off handshower Art. 1000DC, flex.cm 120, angle valve with ceramic headwork and brass shower holder.



1010

Set "Oasis" composto da: doccia a pulsante art. 1010DC, flex. conico cm 120 rubinetto ad angolo quadro con vitone ceramico e supporto in ottone cromato.

"Oasis" set composed of: shut-off handshower Art. 1010DC, flex. cm 120, Square angle valve with ceramic headwork and brass shower holder.



1004Z

Set "Oasis" composto da: doccia a pulsante art. 1004DC, flex. conico cm 120 rubinetto ad angolo con vitone ceramico e supporto in ottone cromato.

"Oasis" set composed of: shut-off handshower Art. 1004DC, flex.cm 120, angle valve with ceramic headwork and brass shower holder.



1000Z

Set "Oasis" composto da: doccia a pulsante art. 1000DCZ, flex. conico cm 120 rubinetto ad angolo con vitone ceramico e supporto in ottone cromato.

"Oasis" set composed of: shut-off handshower Art. 1000DCZ, flex.cm 120, angle valve with ceramic headwork and c.p. brass shower holder.



1012

Set "Oasis", composto da: doccia a pulsante art.1012DC (con chiave pulizia aeratore), flessibile conico 120 cm, rubinetto ad angolo con vitone ceramico e supporto in ottone cromato.

"Oasis" set composed of: shut-off handshower art.1012DC (with cleaning aerator key), conical flex. hose 120cm, angle valve with ceramic headwork and brass shower holder.



1005 EUR

Set composto da doccia a pulsante minimale in ABS cromata Art. 1005DC, flessibile conico metallizzato 120 cm, rubinetto ad angolo "Minimal" in ottone cromato e supporto in ottone cromato.

Set composed by: shut-off handshower minimal in ABS Art. 1005DC, flexible cm 120, angle valve "Minimal" in C.P. brass and c.p. brass shower holder.



1001CR

Set composto da doccia a pulsante minimale in ABS cromata Art. 1001DPCR, flessibile conico metallizzato 120 cm, rubinetto ad angolo in ottone cromato e supporto in ottone cromato.

Set composed by: shut-off handshower minimal in ABS Art. 1001DPCR, flexible cm 120, angle valve in C.P. brass and c.p. brass shower holder.



1000 TEM

Set "Oasis" composto da: doccia a pulsante art. 1000DC, flex. conico cm 120 rubinetto temporizzato 1/2" in ottone cromato tempo d'apertura 6-8 secondi e supporto in ottone cromato.

"Oasis" set composed of: shut-off handshower Art. 1000DC, flex.cm 120, temporized button flusher 1/2" all in Cp brass, opening time 6-8 seconds, and c.p. brass shower holder.



**1011**

Set "Oasis" composto da: doccia a pulsante art. 1000DCZ, flex. conico cm 120 rubinetto ad angolo e supporto in ottone cromato.

"Oasis" set composed of: shut-off handshower Art. 1000DCZ, flex.cm 120, angle valve and c.p. brass shower holder.

**1001**

Set "Sandy Beach" composto da doccia a pulsante bianca 1001DC, flessibile retinato bianco 120 cm, rubinetto ad angolo in ottone cromato e supporto bianco.

"Sandy Beach" set composed by: shut-off handshower with Art. 1001DC, flex. white cm 120, angle valve in C.P. brass and white shower holder.

**1010SR**

Set "Oasis" composto da: doccia a pulsante art. 1010DC, flex. conico cm 120 e supporto in ottone cromato.

"Oasis" set composed of: shut-off handshower Art. 1010DC, flex. cm 120, and c.p. brass shower holder.

**1000SR**

Set "Oasis" composto da: doccia a pulsante art. 1000DC, flex. conico cm 120 e supporto in ottone cromato.

"Oasis" set composed of: shut-off handshower Art. 1000DC, flex.cm 120, and brass shower holder.

**1012SR**

Set "Oasis", composto da: doccia a pulsante art.1012DC (con chiave pulizia aeratore), flessibile conico 120 cm, e supporto in ottone cromato.

"Oasis" set composed of: shut-off handshower art.1012DC (with cleaning aerator key),conical flex. hose 120cm, and brass shower holder.

**1000ZSR**

Set "Oasis" composto da: doccia a pulsante art. 1000DCZ, flex. conico cm 120 e supporto in ottone cromato.

"Oasis" set composed of: shut-off handshower Art. 1000DCZ, flex.cm 120, and brass shower holder.

**1004SR**

Set "Oasis" composto da: doccia a pulsante art. 1004DC, flex. conico cm 120 e supporto in ottone cromato.

"Oasis" set composed of: shut-off handshower Art. 1004DC, flex.cm 120 and c.p. brass shower holder.

**1005 EURSR**

Set composto da doccia a pulsante minimale in ABS cromata Art. 1005DC, flessibile conico metallizzato 120 cm e supporto in ottone cromato.

Set composed by: shut-off handshower minimal in ABS Art. 1005DC, flex. cm 120 and c.p. brass shower holder.

**1001SRCR**

Set "Sandy Beach" composto da doccia a pulsante cromata Art. 1000DPCR, flessibile 120 cm e in ottone cromato.

"Sandy Beach" set composed by: shut-off handshower with Art. 1000DPCR, flexible hose cm 120 and c.p. brass shower holder.

**1001SR**

Set "Sandy Beach" composto da doccia a pulsante bianca Art. 1001DC, flessibile retinato 120 cm e supporto bianco.

"Sandy Beach" set composed by: shut-off handshower with Art. 1001DC, flex. cm 120 and white shower holder.

**A520NR**

Raccordo in ottone 1/2" F x 1/2" M con valvola di non ritorno.
Brass fitting, 1/2F x 1/2M, with non-return valve.

BOX
INCASSO
BUILT-IN
BOXWELLNESS
KITCROMOTERAPIA
COLOUR
THERAPIESOFFIONI
SHOWER
HEADPANNELLI
DOCCIA
SHOWER
PANELSCOLONNE
DOCCIA
SHOWER
COLUMNSALISCENDI
SLIDING RAILSDOCCETTE
HAND
SHOWERSOASIS
SHUT-OFFBOCCHIE
SPOUTSACCESSORI
RUBINETTERIA
TAP
ACCESSORIES

DOCLETTE SHUT-OFF IN ABS - ABS SHUT-OFF HANDSHOWER



1005DC
Doccetta a pulsante minimale in ABS cromata 1/2".
C.P. brass shut-off minimal in ABS 1/2".



1001DC
Doccetta a pulsante bianca 1/2".
C.P. brass shut-off white 1/2".



1001DCCR
Doccetta shut-off cromata in ABS stampata made in italy.
Chrome ABS shut off handshower printed made in italy.



1001DCNE
Doccetta shut-off nera in ABS stampata made in italy.
Black ABS shut off handshower printed made in italy.



1000DPCR
Doccetta a pulsante cromata 1/2".
C.P. ABS shut-off white 1/2".



1000DPBN
Doccetta a pulsante bianca 1/2".
C.P. brass shut-off white 1/2".

DOCCETTE SHUT-OFF IN OTTONE CROMATO - C.P. BRASS SHUT-OFF HANDSHOWER

**1000DCZ**

Doccetta a pulsante in ottone cromato, impugnatura zigrinata 1/2".
C.P. brass shut-off handshower with knurled handgrip 1/2".

**1004DC**

Doccetta a pulsante in ottone cromato, impugnatura zigrinata 1/2".
C.P. brass shut-off handshower with knurled handgrip 1/2".

**1010DC**

Doccetta a pulsante quadrata in ottone cromato 1/2".
C.P. brass shut-off squared handshower 1/2".

**1000DC**

Doccetta a pulsante in ottone cromato, impugnatura liscia 1/2".
C.P. brass shut-off handshower with plain hand grip 1/2".

**1000BDC**

Doccetta a pulsante "Lux" in ottone cromato, con impugnatura bombata 1/2".
C.P. brass shut-off "Lux" handshower with convex handgrip, 1/2".

**1012DC**

Doccetta a pulsante in ottone cromato, impugnatura liscia da 1/2" con kit aeratore e chiave.
C.p. brass shut-off handshower, with plain handgrip, 1/2" complete with aerator and key.

BOX
INCASSO
BUILT-IN
BOXWELLNESS
KITCROMOTERAPIA
COLOUR
THERAPIESOFFIONI
SHOWER
HEADPANNELLI
DOCCIA
SHOWER
PANELSCOLONNE
DOCCIA
SHOWER
COLUMN

DECORAZIONI - DECORATIONS

Doccette disponibili nelle seguenti decorazioni:
Shut off available in the following decorations:

DAMASCO YF



FANTASY YG



SPYRAL YC



POP ART YL



OPTICAL YP

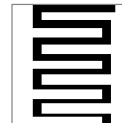

MELODY YM

SALISCENDI
SLIDING RAILSDOCCETTE
HAND
SHOWERSOASIS
SHUT-OFFBOCCE
SPOUTSACCESSORI
RUBINETTERIA
TAP
ACCESSORIES



BOCCHIE - SPOUTS



WELLNESS

BOX
INCASSO
BUILT-IN
BOX

WELLNESS
KIT

CROMOTERAPIA
COLOUR
THERAPIE

SOFFIONI
SHOWER
HEAD

PANNELLI
DOCCIA
SHOWER
PANELS

COLONNE
DOCCIA
SHOWER
COLUMN

SALISCENDI
SLIDING
RAILS

DOCCETTE
HAND
SHOWERS

OASIS
SHUT-OFF

BOCCE
SPOUTS

ACCESSORI
RUBINETTERIA
TAP
ACCESSORIES





Bocca da soffitto in ottone cromato con dispositivo color.
Ceiling spout in chrome plated brass with colour device.

SL204706

lunghezza 166 cm e dispositivo colour.
length 166 cm and colour device.

SL204706X

lunghezza 181 cm e dispositivo colour.
length 181 cm and colour device.



CA4705Q

Bocca bordo vasca a cascata dotato di dispositivo luminoso AMBIENT di retroilluminazione.
Waterfall built-in spout with led light AMBIENT device for back lighting.



OXL4704

Bocca incasso con luce led.
Built-in spout with led light.

CE



SL204704

Bocca incasso con luce led cm 18.
Built-in spout with led light cm 18.

CE

BOCCHIE A CASCATA - WATERFALL SPOUTS

**F4705**

Bocca bordo vasca con effetto multigetto.
*Spout with multijet effect for deck bath/
shower mixer.*

**F4705Q**

Bocca bordo vasca con effetto multigetto.
*Spout with multijet effect for deck bath/
shower mixer.*

**C4705Q**

Bocca bordo vasca a cascata.
Waterfall built-in spout.

**C4704**

Bocca bordo vasca con getto a cascata.
Deck Bath-shower with waterfall jet.

**A590XS**

Soffione/bocca a cascata ad incasso
squadrata in acciaio INOX lucidato a
specchio.
*Squared built-in stainless steel mirror
polished waterfall shower head/spout.*

**A594XM**

Soffione/bocca a cascata ad incasso
con angoli arrotondati in acciaio INOX
lucidato a specchio.
*Built-in stainless steel mirror polished
waterfall shower head/spout with
round corners.*

**A590XL**

Soffione/bocca a cascata ad L in
acciaio INOX lucidato a specchio.
*Stainless steel mirror polished "L"
waterfall shower head/spout.*

**SC4704**

Bocca incasso a cascata.
Built-in spout with waterfall jet.

**CA4704**

Bocca incasso a cascata.
Built-in spout with waterfall jet.

**DC4704**

Bocca incasso a cascata.
Built-in spout with waterfall.

**CW4704**

Bocca incasso a cascata.
Waterfall built-in spout.

BOX
INCASSO
BUILT-IN
BOXWELLNESS
KITCROMOTERAPIA
COLOUR
THERAPIESOFFIONI
SHOWER
HEADPANNELLI
DOCCIA
SHOWER
PANELSCOLONNE
DOCCIA
SHOWER
COLUMNSALISCENDI
SLIDING
RAILSDOCCETTE
HAND
SHOWERSOASIS
SHUT-OFFBOCCHIE
SPOUTSACCESSORI
RUBINETTERIA
TAP
ACCESSORIES



Bocca da soffitto in ottone cromato.
Ceiling spout in chrome plated brass.

S204706

lunghezza 166 cm.
length 166 cm.

S204706X

lunghezza 181 cm.
length 181 cm.



OX4704

Bocca incasso.
Built-in spout.



S204704

Bocca incasso per miscelatore
vasca-doccia cm 18.
*Built-in spout for bath-shower
mixer cm 18.*



DV4704

Bocca incasso.
Built-in spout.



TA4704

Bocca incasso, 19,4 cm.
Built-in spout, 19,4.



FU4704

Bocca incasso.
Lunghezza bocca: 19 cm.
*Built-in spout.
Spout Length: 19 cm.*

**TK4704**

Bocca incasso.
Lunghezza bocca: 19 cm.
Built-in spout.
Lenght spout: 19 cm.

**SP4704**

Bocca incasso.
Lunghezza: 19 cm.
Built-in spout.
Lenght: 19 cm.

**OM4704**

Bocca incasso.
Built-in spout.

**OM4702**

Bocca incasso con deviatore.
Built-in spout with diverter.

**SK4704**

Bocca incasso.
Built-in spout.

**SK4702**

Bocca incasso con deviatore integrato.
Built-in spout with diverter.

**K4704**

Bocca incasso.
Built-in spout.

**K4702**

Bocca incasso con deviatore.
Built-in spout with diverter.

**Q4704**

Bocca incasso.
Built-in spout.

**Q4702**

Bocca incasso con deviatore.
Built-in spout with diverter

**4704**

Bocca incasso.
Built-in spout.

**4702**

Bocca incasso vasca-doccia, con deviatore integrato.
Built-in spout for bath-shower, with integrated diverter.

**W4704**

Bocca incasso.
Built-in spout.

**L4704**

Bocca incasso.
Built-in spout.

BOX
INCASSO
BUILT-IN
BOX

WELLNESS
KIT

CROMOTERAPIA
COLOUR
THERAPIE

SOFFIONI
SHOWER
HEAD

PANNELLI
DOCCIA
SHOWER
PANELS

COLONNE
DOCCIA
SHOWER
COLUMN

SAISCENDI
SLIDING
RAILS

DOCCETTE
HAND
SHOWERS

OASIS
SHUT-OFF

BOCCE
SPOUTS

ACCESSORI
RUBINETTERIA
TAP
ACCESSORIES



ACCESSORI RUBINETTERIA TAPS ACCESSORIE



BOX
INCASSO
BUILT-IN
BOX

WELLNESS
KIT

CROMOTERAPIA
COLOUR
THERAPIE

SOFFIONI
SHOWER
HEAD

PANNELLI
DOCCIA
SHOWER
PANELS

COLONNE
DOCCIA
SHOWER
COLUMN

SALISCENDI
SLIDING RAILS

DOCCETTE
HAND
SHOWERS

OASIS
SHUT-OFF

BOCCHIE
SPOUTS

ACCESSORI
RUBINETTERIA
TAP
ACCESSORIES

RUBINETTI SOTTOLAVABO - ANGLE VALVES



A600
Rubinetto sottolavabo con maniglia a leva,
1/2x3/8 - 1/2x1/2 - 1/2x10.
C.P. angle valve with lever handle,
1/2x3/8 - 1/2x1/2 - 1/2x10.



A601
Rubinetto sottolavabo quadrato con vitone
ceramico, 1/2x3/8 - 1/2x1/2 - 1/2x10.
Angle valve squared with ceramic head
valve, 1/2x3/8 - 1/2x1/2 - 1/2x10.



A602
Rubinetto sottolavabo esagonale con vitone
ceramico, 1/2x3/8 - 1/2x1/2 - 1/2x10.
Angle valve hexagonal with ceramic head
valve, 1/2x3/8 - 1/2x1/2 - 1/2x10.



A605
Rubinetto sottolavabo con filtro e rosetta in
ottone cromato,
1/2x3/8 - 1/2x1/2 - 1/2x10 - 1/2x3/4.
C.P. angle valve with filter and flange,
1/2x3/8 - 1/2x1/2 - 1/2x10 - 1/2x3/4.



A610
Rubinetto sottolavabo con filtro e snodo, con
rosetta in ottone cromato, 1/2x10.
C.P. angle valve with filter, ball joint and flange,
1/2x10.



A612
Rubinetto sottolavabo a vitone con filtro
e snodo, con rosetta in ottone cromato,
1/2x10.
C.P. brass angle valve with filter, balljoint and
c.p. brass flange, 1/2x10.



A606
Rubinetto a sfera con guarnizione in PTFE e
rosetta. 1/2x3/8 - 1/2x1/2.
C.P. brass ball valve with PTFE washer and
flange. 1/2x3/8 - 1/2x1/2.



A620
Rubinetto sottolavabo con filtro e rosetta in
ottone cromato. 1/2x3/8 - 1/2x1/2, 1/2x10.
C.P. angle valve with filter and flange.
1/2x3/8 - 1/2x1/2, 1/2x10.



A611
Rubinetto sottolavabo con rosetta.
1/2x3/8 - 1/2x1/2.
C.p. angle valve with wall flange.
1/2x3/8 - 1/2x1/2.



A611L
Rubinetto sottolavabo lusso con rosetta.
1/2x3/8 - 1/2x1/2.
Luxury c.p. angle valve with wall flange.
1/2x3/8 - 1/2x1/2.



A615
Rubinetto combinato 1/2 sottolavabo e 3/4
attacco lavatrice.
Union valve 1/2 with under sink coupling and
3/4 connection for washing machine.



A625
Curvetta sottolavabo 1/2x10 con rosetta in
ottone cromato.
C.P. elbow connection for washbasin. with
flange 1/2x10.



A640
Distanziatore per gruppi con rubinetto lavatrice,
3/4x3/4x3/4.
C.P. washing machine bibcock with connection,
3/4x3/4x3/4.



A626
Curvetta sottolavabo stampata 1/2x10 con
rosetta in ottone cromato.
Cp brass forged elbow connection for
washbasin with flange 1/2x10.



A640RA
Distanziatore per gruppi, 3/4x3/4.
C.P. brass connection for mixers, 3/4x3/4.



A645
Rubinetto a tre vie sottolavabo per attacco lavatrice, 1/2x3/4.
C.P. three ways washing machine bibcock, brass model, 1/2x3/4.



A650
Deviatore doccia per canna livello Ø18 mm. 3/4Mx3/4Fx1/2M.
C.P. diverter for shower, for sink spout Ø18 mm. 3/4Mx3/4Fx1/2M.



A660
Rubinetto a sfera per lavatrice, maniglia a farfalla con rosetta in ottone cromato. 1/2x1/2 - 3/8x3/4 - 1/2x3/4.
C.P. hose bibcock for washing machine, with flange. 1/2x1/2 - 3/8x3/4 - 1/2x3/4.



A660NR
Rubinetto a sfera con valvola di non ritorno con rosetta ottone cromato, 1/2x3/4.
CP Hose bibcock for washing machine with flange in Cp brass with no-return valve, 1/2x3/4.



A675
Rubinetto sottolavabo con rosetta. 1/2x3/8 - 1/2x1/2 - 1/2x10.
C.p. brass angle valve with flange. 1/2x3/8 - 1/2x1/2 - 1/2x10.



A690
Rubinetto portagomma a sfera, maniglia a leva e cromato, 1/2.
Cp ball bibcock, Hose-end with lever handle, 1/2.

PASSO RAPIDO E RUBNETTI DA GIARDINO - FLUSHING VALVE AND GARDEN TAPS



A691
Rubinetto portagomma a sfera tipo pesante maniglia a leva cromato, 1/2 - 3/4.
Brass ball bibcock, Heavy Type, hose-end with lever handle, 1/2 - 3/4.



A692
Rubinetto portagomma in ottone tipo pesante, 1/2 - 3/4.
Hose end bibcock in brass heavy type, 1/2 - 3/4.



A695
Rubinetto curvo da giardino in ottone giallo trattato, 1/2 a maniglia, con rosetta pesante aeratore e riduzione 3/4 per portagomma.
Plain-end garden bibcock, heavy duty in treated yellow brass, 1/2 traditional handle, with heavy flange, aerator and 3/4 reduction for hose connection.



A696
Rubinetto curvo da giardino in ottone giallo trattato, 1/2 a leva, con rosetta pesante aeratore e riduzione 3/4 per portagomma.
Plain-end garden bibcock, heavy duty in treated yellow brass, 1/2 lever type, with heavy flange, aerator and 3/4 reduction for hose connection.



A171
Passo rapido ad incasso con ritorno automatico, 3/4 - 1".
Built-in flushing valve with automatic return, 3/4 - 1".

BOX
INCASSO
BUILT-IN
BOX

WELLNESS
KIT

CROMOTERAPIA
COLOUR
THERAPIE

SOFFIONI
SHOWER
HEAD

PANNELLI
DOCCIA
SHOWER
PANELS

COLONNE
DOCCIA
SHOWER
COLUMN

SALISCENDI
SLIDING
RAILS

DOCCETTE
HAND
SHOWERS

OASIS
SHUT-OFF

BOCCHIE
SPOUTS

ACCESSORI
RUBINETTERIA
TAP
ACCESSORIES

ACCESSORI PER RUBINETTERIA - TAPS ACCESSORIES

PROLUNGHE E ROSONI - EXTENSIONS AND WALL FLANGES



A276CR

Prolunghe in ottone cromato, con broccia.
C.P. brass extension

1/2	10	15	20	25	30	40	50	60	80	100
3-4	10	15	20	25	30	40	50	60	80	100



A276PCR

Prolunghe in ottone cromato, tipo pesante Ø 27 mm, con broccia.
C.P. brass extension Ø 27 mm.

1/2	10	15	20	25	30	40	50	60	80	100
-----	----	----	----	----	----	----	----	----	----	-----



A278CR

Prolunghe ridotte in ottone cromato.
Reduction piece round in C.P. brass.

1/2x3/8	1/2x3/4	3/4x1"
---------	---------	--------



A684

Rosone a muro in ottone cromato, Ø est. mm 77.
Standard wall flange in c.p. brass, ext. Ø mm 77.

Ø 26	Ø 30	Ø 32	Ø 40
------	------	------	------



A682

Rosone a muro in ottone cromato.
Standard wall flange in c.p. brass.

Ø 26	Ø 30	Ø 32
------	------	------



A681

Rosetta pesante in ottone cromato 1/2.
Heavy wall flange in chrome plated brass 1/2.



A683

Rosone a muro quadrato con OR in ottone cromato, per serie quadrate e sifoni misure: Ø 32.
Heavy wall flange with OR in cp. brass, for squared series and traps Dimensions: Ø 32.



A680

Rosone a muro con OR in ottone cromato per serie minimali Ø 32.
Heavy wall flange for traps in Cp brass, for minimal series Ø 32.

SCARICHI CLICK-CLACK - CLICK-CLACK WASTES



A732

Scarico automatico con sistema click-clack, 1"1/4, con troppo pieno.
Automatic pop-waste, click-clack system, 1"1/4, with overflow.



A732C

Scarico automatico con sistema click-clack, 1"1/4, con troppo pieno, modello con bicchiere corto.
Automatic pop-waste, click-clack system, 1"1/4, with overflow, model with shorter cup.



A734

Scarico automatico 1"1/4 con tappo grande sempre aperto e sistema click-clack per la pulizia interna.
Automatic pop-up waste 1"1/4 with big plug always opened, and click-clack system for internal cleaning.



A734C

Scarico automatico 1"1/4 con tappo grande sempre aperto e sistema click-clack per la pulizia interna, modello con bicchiere corto.
Automatic pop-up waste 1"1/4 with big plug always opened, and click-clack system for internal cleaning, model with shorter cup.

**A735**

Scarico automatico con sistema click-clack, 1"1/4, e tappo grande, con troppo pieno.
Automatic pop-waste, click-clack system, 1"1/4, big plug, with overflow.

**A735C**

Scarico automatico con sistema click-clack, 1"1/4, e tappo grande, con troppo pieno, modello con bicchiere corto.
Automatic pop-waste, click-clack system, 1"1/4, big plug, with overflow., model with shorter cup.

**A736**

Scarico automatico con sistema click-clack, 1"1/4, e tappo grande, senza troppo pieno.
Automatic pop-waste, click-clack system, 1"1/4, big plug, without overflow.

**A736C**

Scarico automatico con sistema click-clack, 1"1/4, e tappo grande, senza troppo pieno, modello con bicchiere corto.
Automatic pop-waste, click-clack system, 1"1/4, big plug, without overflow, model with shorter cup.

**A737**

Scarico automatico quadrato 1"1/4 con Click-clack con troppo pieno.
Squared automatic pop-up waste 1"1/4 with Click clack system with overflow.

**A737C**

Scarico automatico quadrato 1"1/4 con click-clack con troppo pieno, modello con bicchiere corto.
Squared automatic pop-up waste 1"1/4 with click-clack system with overflow, model with shorter cup.

**A738**

Scarico automatico quadrato 1"1/4 con Click-clack senza troppo pieno.
Squared automatic pop-up waste 1"1/4 with Click clack system without overflow.

**A738C**

Scarico automatico quadrato 1"1/4 con click-clack senza troppo pieno, modello con bicchiere corto.
Squared automatic pop-up waste 1"1/4 with click-clack system without overflow, model with shorter cup.

**A735R**

Scarico automatico universale con chiusura click-clack da 1"1/4.
Universal automatic pop-up waste 1"1/4 with click-clack system.

**A735XL**

Scarico automatico universale con chiusura click-clack da 1"1/4, tappo grande, con troppo pieno, versione extralunga.
Universal automatic pop-up waste 1"1/4 with click-clack system.

**A671**

Copriforo per lavabo e bidet Ø50 verniciato bianco tipo pesante.
White hole cover for washbasin and bidet Ø50 heavy type.

**A670**

Tappo copriforo per lavabo e bidet.
Hole cover for washbasin and bidet.

BOX
INCASSO
BUILT-IN
BOXWELLNESS
KITCROMOTERAPIA
COLOUR
THERAPIESOFFIONI
SHOWER
HEADPANNELLI
DOCCIA
SHOWER
PANELSCOLONNE
DOCCIA
SHOWER
COLUMNSALISCENDI
SLIDING
RAILSDOCCETTE
HAND
SHOWERSOASIS
SHUT-OFFBOCCHE
SPOUTSACCESSORI
RUBINETTERIA
TAP
ACCESSORIES



A750

Sifone minimale in ottone cromato 1"1/4.
C.P. brass minimal P trap 1"1/4.



A755

Sifone "Minimal" in ottone cromato per bidet.
C.P. brass "Minimal" P trap for bidet.



A740

Sifone squadrato in ottone cromato 1"1/4.
C.P. brass "Square" P trap 1"1/4.



A758

Sifone in ottone cromato 1"1/4.
C.P. brass P trap 1"1/4.



A767

Sifone ad U per lavabo a colonna in ottone cromato, canotto cm 25.
1" - 1" 1/4.
Cp brass U trap 25cm outlet tube. 1" - 1" 1/4



A760

Sifone fuso pesante lusso in ottone cromato per lavabo e bidet. 1" - 1" 1/4
C.P. brass luxury P trap heavy type, for wash basin and bidet. 1" - 1" 1/4.



A745

Sifone esagonale in ottone cromato 1"1/4.
Cp brass "Hexagonal" P Trap 1"1/4.



A766Z

Sifone a S, canotto cm 25 in zama. 1" 1/4.
S trap 25 cm outlet tube in zama. 1" 1/4.



A765Z

Sifone a bottiglia, canotto cm 25 in zama, 1" 1/4.
Bottle trap, 25 cm outlet tube in zama, 1" 1/4.



A765P

Sifone a bottiglia, canotto cm 25 in plastica, 1" 1/4.
Bottle trap, 25 cm outlet tube in plastic, 1" 1/4.

**A766**

Sifone a S, canotto cm 25 in ottone cromato, 1" - 1" 1/4.
S trap 25 cm outlet tube in Cp brass, 1" - 1" 1/4.

**A765**

Sifone a bottiglia, canotto cm 25 in ottone cromato, 1" - 1" 1/4.
Bottle trap, 25 cm outlet tube in c.p. brass, 1" - 1" 1/4.



Sifone salvaspazio con piletta click-clack incorporata, rotondo, cromato.
Save-spacing siphon with click-clack built-in drain, round, chrome.

A785

con troppo pieno.
with overflow.

A786

senza troppo pieno.
without overflow.



Sifone salvaspazio con piletta click-clack incorporata, quadrata, cromato.
Save-spacing siphon with click-clack built-in drain, squared, chrome.

A787

con troppo pieno.
with overflow.

A788

senza troppo pieno.
without overflow.

BOX
 INCASSO
 BUILT-IN
 BOX

WELLNESS
 KIT

CROMOTERAPIA
 COLOUR
 THERAPIE

SOFFIONI
 SHOWER
 HEAD

PANNELLI
 DOCCIA
 SHOWER
 PANELS

COLONNE
 DOCCIA
 SHOWER
 COLUMN

SALISCENDI
 SLIDING
 RAILS

DOCCETTE
 HAND
 SHOWERS

OASIS
 SHUT-OFF

BOCCE
 SPOUTS

ACCESSORI
 RUBINETTERIA
 TAP
 ACCESSORIES

AERATORI - AERATORS



A803EU

Aeratore Neoperl M24 coin slot. Installazione e rimozione dell'aeratore utilizzando una moneta inserita nell'apposita fessura.

Neoperl aerator M24 coin slot. Installation and removal of the aerator by using a coin placed in the slot.



A803FLAT

Aeratore M24 ultrapiatto, utilizzabile su ogni lavabo o lavello.

Ultra-flat aerator M24, suitable on every wash-basin or sink.



A803NEBA

Aeratore Neoperl M24X1 con getto direzionabile tramite terminale basculante, permette con il semplice tocco della parte inferiore dell'aeratore di dirigere il flusso nella direzione desiderata.

Neoperl aerator M24X1 with movable aerator bottom that, with the simple touch, permits to move the flow to the preferred direction.



A801CR16

Aeratore F16x1.

Aerator F16x1.



A801

Aeratore per gruppo lavello F22.

Aerator for sink spout F22.



A803

Aeratore per lavabo, lavello e bidet M24.

Aerator for washbasin, sink and bidet mixer M24.



A804

Aeratore per gruppi vasca M28.

Aerator for bath mixer M28.



A803CR18

Aeratore serie Diva, M18x1.

Diva aerator, M18x1.



A805

Aeratore con snodo per monoforo bidet M24.

Ball joint aerator for bidet mixer M24.



A803KIT1

Set completo di 3 aeratori anticalcare M24 ad alta tecnologia + 1 chiave per la pulizia settimanale, brevettati e di lunghissima durata, il tutto in ottone cromato e materiale plastico innovativo a forte resistenza, confezionato in un tubo contenitore rigido e trasparente adatto per essere appeso. La chiave è stata studiata per pulire il calcare dall'aeratore in un solo semplice movimento.

Set complete of 3 anti-limestone M24 aerators of high technology + 1 weekly cleaning key, patented and extremely long lasting, all in c.p. brass and innovative plastic material very resistant, packed in a holding hard and transparent tube, suitable to be hang. The key has been studied to clean the aerator in one simple, easy movement.



A803KIT2

Set completo di 2 aeratori anticalcare M24 e 1 aeratore anticalcare F22 + 1 chiave per la pulizia settimanale, brevettati e di lunghissima durata, il tutto in ottone cromato e materiale plastico innovativo a forte resistenza, confezionato in un tubo contenitore rigido e trasparente adatto per essere appeso. La chiave è stata studiata per pulire il calcare dall'aeratore in un solo semplice movimento.

Set complete of 2 anti-limestone M24 aerators and 1 anti-limestone F22 aerator + 1 weekly cleaning key, patented and extremely long lasting, all in c.p. brass and innovative plastic material very resistant, packed in a holding hard and transparent tube, suitable to be hang. The key has been studied to clean the aerator in one simple, easy movement.



A801K

Set completo di 1 aeratore F22 anticalcare ad alta tecnologia + 1 chiave di pulizia settimanale, brevettati e di lunghissima durata, il tutto in ottone cromato e materiale plastico innovativo a forte resistenza. L'aeratore e la chiave sono stati studiati per pulire il calcare dall'aeratore in un solo semplice movimento.

Set complete of 1 anti-limestone F22 aerator of high technology + 1 weekly cleaning key, Patented and extremely long lasting, all in c.p. brass and innovative plastic material very resistant. The aerator and the key has been studied to clean the aerator in one simple, easy movement.



A803K

Set completo di 1 aeratore M24 anticalcare ad alta tecnologia + 1 chiave di pulizia settimanale, brevettati e di lunghissima durata, il tutto in ottone cromato e materiale plastico innovativo a forte resistenza. L'aeratore e la chiave sono stati studiati per pulire il calcare dall'aeratore in un solo semplice movimento.

Set complete of 1 anti-limestone M24 aerator of high technology + 1 weekly cleaning key, Patented and extremely long lasting, all in c.p. brass and innovative plastic material very resistant. The aerator and the key has been studied to clean the aerator in one simple, easy movement.



A803 AV

Kit antivandalico e anticalcare composto da aeratore speciale per miscelatori lavabo e bidet M24 e chiave di montaggio, manutenzione e pulizia settimanale, ad alta tecnologia, brevettata.

Anti-vandalism and anti-limestone kit, composed by special aerator for wash basin and bidet mixers M24 and assembly, caring and weekly cleaning key, high technology and patented.



A520FI 12

Guarnizione da 1/2" con filtro retinato anti-impurità.

1/2" washer with net filter, anti-impurity.



A520RE 12

Guarnizione da 1/2" a passaggio ridotto, con risparmio idrico del 30%.

1/2" Washer, reduced flow, water saving 30%.



A803 AV L6

Kit antivandalico e anticalcare composto da aeratore speciale per miscelatori lavabo e bidet M24 e chiave di montaggio, manutenzione e pulizia settimanale, ad alta tecnologia, brevettata, limitatore di portata da 6 litri al minuto.

Anti-vandalism and anti-limestone kit, composed by special aerator for wash basin and bidet mixers M24 and assembly, caring and weekly cleaning key, high technology and patented, one reduction of water consumption at 6 liters by minute



A803 AV L8

Kit antivandalico e anticalcare composto da aeratore speciale per miscelatori lavabo e bidet M24 e chiave di montaggio, manutenzione e pulizia settimanale, ad alta tecnologia, brevettata, limitatore di portata da 8 litri al minuto.

Anti-vandalism and anti-limestone kit, composed by special aerator for wash basin and bidet mixers M24 and assembly, caring and weekly cleaning key, high technology and patented, one reduction of water consumption at 8 liters by minute



A803 SET L6

Set risparmio idrico totale composto da raccordo doccia 1/2" in ottone cromato a portata limitata, aeratore lavabo e bidet M24 a portata limitata e chiave di montaggio manutenzione e pulizia settimanale, ad alta tecnologia, brevettata. Il kit è disponibile in varianti da 6 litri al minuto.

Total water saving set, composed by 1/2" shower connection with reduced flow in c.p. brass, wash basin and bidet aerator with reduced flow and assembling, caring and weekly cleaning key, high technology, patented. This set is available with outlet flow of 6 liters by minute.



A803 SET L8

Set risparmio idrico totale composto da raccordo doccia 1/2" in ottone cromato a portata limitata, aeratore lavabo e bidet M24 a portata limitata e chiave di montaggio manutenzione e pulizia settimanale, ad alta tecnologia, brevettata. Il kit è disponibile in varianti da 8 litri al minuto.

Total water saving set, composed by 1/2" shower connection with reduced flow in c.p. brass, wash basin and bidet aerator with reduced flow and assembling, caring and weekly cleaning key, high technology, patented. This set is available with outlet flow of 8 liters by minute.



A803 L6 - A803 L8

Aeratore lavabo e bidet M24, per risparmio idrico con limitatore di portata da 6 litri al minuto (art. A803 L6) o da 8 litri al minuto (art. A803 L8).

Aerator for wash basin and bidet mixers, M24, water saving, with reduction of consumption and excellent flow at 6 litres by minute (art. A803 L6) or 8 liters by minute (art. A803 L8).



A520R L6 - A520R L8

Raccordo doccia 1/2" a risparmio idrico con limitatore di portata da 6 litri al minuto (art. A520R L6) o 8 litri al minuto (art. A520R L8).

C.p. brass connection, water saving program with flow reduction at 6 liters by minute (art. A520R L6) or 8 liters by minute (art. A520R L8).

BOX
INCASSO
BUILT-IN
BOX

WELLNESS
KIT

CROMOTERAPIA
COLOUR
THERAPIE

SOFFIONI
SHOWER
HEAD

PANNELLI
DOCCIA
SHOWER
PANELS

COLONNE
DOCCIA
SHOWER
COLUMN

SALISCENDI
SLIDING RAILS

DOCCETTE
HAND
SHOWERS

OASIS
SHUT-OFF

BOCCHE
SPOUTS

ACCESSORI
RUBINETTERIA
TAP
ACCESSORIES

CARTUCCE E FISAGGI - CARTRIDGES FIXING SET



A846
Cartuccia Ø25 mm (tipo aperto).
Ceramic cartridge Ø25 mm (opened type).



A846C
Cartuccia Ø25 mm (tipo chiuso).
Ceramic cartridge Ø25 mm (closed type).



A810
Cartuccia Ø40 mm a dischi di ceramica (tipo con distributore).
Ceramic cartridge Ø40 mm (type with distributor).



A820
Cartuccia Ø35 mm a dischi di ceramica (tipo con distributore).
Ceramic cartridge Ø35 mm (type with distributor).



A815
Cartuccia Ø40 mm a dischi di ceramica (tipo piatto).
Ceramic cartridge Ø40 mm (flat bottom type).



A825
Cartuccia Ø35 mm a dischi di ceramica (tipo piatto).
Ceramic cartridge Ø35 mm (flat bottom type).



A830
Cartuccia Ø35 mm modello "joystick" (tipo con distributore).
Cartridge Ø35 mm type "joystick" (type with distributor).



A835
Cartuccia Ø35 mm modello "joystick" (tipo piatto).
Cartridge Ø35 mm type "joystick" (flat bottom type).



A840
Cartuccia Ø40 mm modello "joystick" (tipo con distributore).
Cartridge Ø40 mm type "joystick" (type with distributor).



A845
Cartuccia Ø25 mm per Serie Oxy.
Cartridge Ø25 mm for Serie Oxy.



A821
Cartuccia Ø35 mm a dischi ceramici per lavello, doccia, vasca, bidet (tipo piatto).
Ceramic cartridge Ø35 mm for sink, shower, bath, bidet (flat bottom type).



A820TH
Cartuccia termostatica con apertura del flusso per serie X-Factor.
Thermostatic cartridge with flow opening, for X-Factor serie.



A815TH
Cartuccia termostatica coassiale.
Thermostatic coaxial cartridge.



FIS605
Confezione di fissaggio per Serie Eco.
Fixing set for Serie Eco.



FIS605VE
Confezione di fissaggio per Serie Serena e Venus.
Fixing set for Serie Serena and Venus.



FISDV605
Confezione di fissaggio per Serie Diva.
Fixing set for Serie Diva.

VITONI E DEVIATORI - HEADVALVES AND DIVERTERS

**A850 DX**

Vitone 180° a dischi ceramici, broccia Ø8 mm, destro.
Head valve 180° ceramic disks, broach Ø8 mm, right.

**A850 SX**

Vitone 180° a dischi ceramici, broccia Ø8 mm, sinistro.
Head valve 180° ceramic disks, broach Ø8 mm, left.

**A850 DX90**

Vitone 90° a dischi ceramici, broccia Ø8 mm, destro.
Head valve 90° ceramic disks, broach Ø8 mm, right.

**A850 SX90**

Vitone 90° a dischi ceramici, broccia Ø8 mm, sinistro.
Head valve 90° ceramic disks, broach Ø8 mm, left.

**A852 DX**

Vitone 90° a dischi ceramici, broccia Ø8 mm, destro, per Serie Twin.
Head valve 90° ceramic disks, broach Ø8 mm, right, for Twin Serie.

**A852 SX**

Vitone 90° a dischi ceramici, broccia Ø8 mm, sinistro, per Serie Twin.
Head valve 90° ceramic disks, broach Ø8 mm, left, for Twin Serie.

**A850THP**

Cartuccia termostatica con rotazione manopola a 330° angolari, blocco di sicurezza a 38°C, campo di lavoro da 5°C a 80°C, campo di pressione da 1 a 10 bar, filtro inox e sistema di sicurezza con blocco dell'erogazione in caso di mancanza di una delle due acque, realizzato con materiali termoplastici ad elevata robustezza.

Thermostatic cartridge with 330° angular handle rotation, 38° safety lock, working field from 5°C to 80°C, pressure field from 1 to 10 bar, stainless steel filter and safety system with the outlet lock in case there is one water lock, high performance thermoplastic materials.

**A851**

Vitone normale broccia 8x20.
Head valve broach 8x20.

**A853 DX**

Vitone 90° a dischi ceramici con asta lunga per 3 fori Revival.
Head valve 90° ceramic disks with long rod for 3-holes Revival.

**A870DE**

Deviatore in ottone, automatico, con molla e fermo per basse pressioni.
Automatic brass diverter with spring and lock for low pressure.

**A870RO**

Eccentrico per gruppi, tipo lusso con rosone in ottone cromato.
Eccentric union for mixers, luxury type, with c.p. brass flange.

**DEV612**

Deviatore in ottone per miscelatori doccia incasso, pomolo tondo, automatico, con molla.
Automatic brass diverter for built-in shower mixers, with round knob and spring.

**DEV612Q**

Deviatore in ottone per miscelatori doccia incasso, pomolo quadrato, automatico, con molla.
Automatic brass diverter for built-in shower mixers, with squared knob and spring.

**E5612PROL**

Prolunga per corpo monocomando doccia incasso con deviatore per cartuccia Ø 40 mm o termostatica.
Extension for built-in shower mixer body with diverter for cartridge Ø 40 mm or thermostatic.

**DV612PROL**

Prolunga per corpo monocomando doccia incasso con deviatore per cartuccia Ø 35 mm.
Extension for built-in shower mixer body with diverter for cartridge Ø 35 mm.

**A815PROL**

Prolunga per corpo monocomando doccia incasso con cartuccia Ø 40 mm.
Extension for built-in shower mixer body with cartridge Ø 40 mm.

**A825PROL**

Prolunga per corpo monocomando doccia incasso con cartuccia Ø 35 mm.
Extension for built-in shower mixer body with cartridge Ø 35 mm.

BOX
INCASSO
BUILT-IN
BOXWELLNESS
KITCROMOTERAPIA
COLOUR
THERAPIESOFFIONI
SHOWER
HEADPANNELLI
DOCCIA
SHOWER
PANELSCOLONNE
DOCCIA
SHOWER
COLUMNSALISCENDI
SLIDING
RAILSDOCCETTE
HAND
SHOWERSOASIS
SHUT-OFFBOCCHE
SPOUTSACCESSORI
RUBINETTERIA
TAP
ACCESSORIES

CANNE - SPOUTS



A860S
Canna lavello inferiore "S" con aeratore.
Lower "S" sink spout with aerator.



A861S
Canna fusa a "S" per lavello a muro con aeratore.
Wall mounted sink "S" casted spout with aerator.



A862T
Canna a biscotto a "C" con calotta da 3/4, con aeratore.
"C" spout with nut 3/4, with aerator.



A861F
Canna fusa per lavello con aeratore.
Sink casted spout with aerator.



Canna a biscotto diritta, calotta da 3/4, con aeratore.
Straight spout with 3/4 nut, with aerator.



A861D
Canna fusa lunga cm 30 con deviatore, con calotta da 3/4 ed aeratore.
Casted cm 30 long spout with diverter, with 3/4 nut, with aerator.



A860U
Canna lavello superiore a "U" con aeratore.
Upper "U" sink spout with aerator.



A862TC
Canna a biscotto a "C" con calotta da 3/4, con aeratore, tipo corto.
"C" spout with nut 3/4, with aerator, short type.



A861FC
Canna fusa a "C" con calotta da 3/4, con aeratore, tipo corto.
Casted "C" spout with nut 3/4, with aerator, short type.



Canna a biscotto ad "S", calotta da 3/4, con aeratore.
"S" spout with 3/4 nut, with aerator.

A862 TD 16 lunghezza cm 16.
16 cm long.

A862 TD 20 lunghezza cm 20.
20 cm long.

A862 TD 30 lunghezza cm 30.
30 cm long.

A862 TD 40 lunghezza cm 40.
40 cm long.

A862 TD 50 lunghezza cm 50.
50 cm long.

A862S 16 lunghezza cm 16.
16 cm long.

A862S 20 lunghezza cm 20.
20 cm long.

A862S 30 lunghezza cm 30.
30 cm long.



A860J
Canna fusa per lavello con aeratore.
Sink casted spout with aerator.



A698CNM
Bocca alta minimale.
High minimal spout.



A862U
Canna a "U" Ø 22, con aeratore.
"U" spout Ø 22, with aerator.



A862P
Canna girevole per lavello, con aeratore.
Swivelling spout for sink, with aerator.



A698CNQ
Bocca alta quadrata.
High squared spout.

COLONNE VASCA - BATH COLUMNS

**A880XL**

Coppia colonne da pavimento in ottone cromato, 3/4M x 3/4M.
Couple c.p. brass floor columns for bath mixer 3/4M x 3/4M.

**A880XLSU**

Coppia colonne vasca in ottone cromato, con supporto doccia, 3/4M x 3/4M.
Couple c.p. brass vertical connections for bath mixer, with hand shower holder 3/4M x 3/4M.

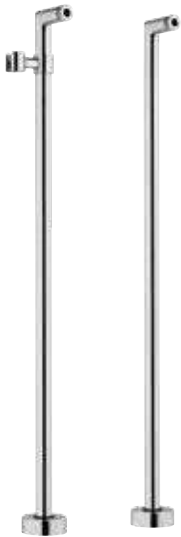
**A880XLM**

Coppia colonne vasca in ottone cromato, minimale, con supporto doccia, 3/4M x 3/4M.
Couple c.p. brass vertical connections for bath mixer, minimalist, with hand shower holder 3/4M x 3/4M.

**A880**

Colonnina bordo vasca in ottone cromato 1/2Mx3/4M.
C.P. brass vertical connection for bath mixer 1/2Mx3/4M.

**A880UK**

Coppia colonnette bordo vasca in ottone cromato, 3/4Mx3/4M.
Couple C.P. brass connections for bath mixer, 3/4Mx3/4M.

**A880V**

Coppia colonnette bordo vasca in ottone cromato "Revival" 3/4Mx3/4M.
Couple c.p. Brass vertical connection for bath mixer "Revival" 3/4Mx3/4M.

**A4491SUP**

Supporto per doccetta estraibile per bordo lavello e bordo vasca, modello a base tonda.
Support for extensible handshower for deck bath and deck sink, round base model.

**A4491SUPQ**

Supporto dritto per doccetta estraibile per bordo lavello e bordo vasca, modello a base quadra.
Straight support for extensible handshower for deck bath and deck sink, squared base model.

BOX
INCASSO
BUILT-IN
BOXWELLNESS
KITCROMOTERAPIA
COLOUR
THERAPIESOFFIONI
SHOWER
HEADPANNELLI
DOCCIA
SHOWER
PANELSCOLONNE
DOCCIA
SHOWER
COLUMNSALISCENDI
SLIDING
RAILSDOCCETTE
HAND
SHOWERSOASIS
SHUT-OFFBOCCHE
SPOUTSACCESSORI
RUBINETTERIA
TAP
ACCESSORIES

SCARICHI - WASTES



A715

Colonna di scarico in plastica con piletta "click clack".
Plastic bath waste and overflow with "click clack" waste.



A710

Colonna di scarico automatica in plastica con filo esterno, senza dado e codulo.
Plastic combined bath waste with automatic pop-up with external wire.



A700

Colonna di scarico automatica con filo esterno e tubo in rame senza dado e codulo.
C.P. brass automatic bath waste and overflow with external wire and copper tube.



A700VA

Colonna di scarico automatico con filo esterno e tubo in rame cm 70, per vasca ad angolo.
C.P. brass automatic bath waste, overflow and copper tube, cm 70, for bath tube edge.



A705

Colonna di scarico automatica con piletta "click clack".
C.P. brass bath waste and overflow with "click clack" waste.



Piletta per doccia con piastra cromata.
Waste for shower tray, with chrome plated.

A911 90

Ø 90, con uscita scarico Ø mm 40, per piatto doccia con foro Ø 60 mm.
Ø 90, outlet pipe Ø mm 40, for shower tray with hole Ø 60 mm.

A911 20

Ø 120, con uscita scarico Ø mm 50, per piatto doccia con foro Ø 90 mm.
Ø 120, outlet pipe Ø mm 50, for shower tray with hole Ø 90 mm.



A705LIT

Colonna di scarico con sifone per vasca con tubo in rame cromato, tutta cromata.
Bath brass waste with siphon, trap and chromated copper tube, all in chrome plated.



A705LICC

Colonna di scarico con sifone per vasca con tubo in rame cromato e piletta click-clack, tutta cromata.
Bath brass waste with siphon, trap, chromated copper tube and click clack waste, all in chrome plated.



A780

Sifone pesante in ottone fuso con dado 1"1/2 per colonna vasca.
Heavy trap in casting brass, with nut 1"1/2 for bath waste.



A780PL

Sifone in plastica per vasca, 1"1/2 x 40.
Siphon for bathtub in white P.P., 1"1/2 x 40.

**A902**

Scarico automatico da 1"1/4, tipo lusso lucidato, con tappo grande a copertura totale della piletta.
C.P. polished pop-up waste, 1"1/4, luxury type with big plug covering the drain.

**A900**

Scarico automatico 1", 1"1/4.
C.P. brass pop-up waste 1"1/4.

**A900E**

Scarico automatico, 1"1/4.
C.P. brass pop-up waste 1"1/4.

**A901**

Scarico automatico, tipo lusso lucidato, 1"1/4.
C.p. polished pop-up waste, luxury type, 1"1/4.

**A900AM**

Scarico tipo Americano, in ottone pulito e cromato.
C.p. waste model American, polished and in c.p. brass.

**A902S**

Scarico automatico da 1"1/4, tipo lusso lucidato, con tappo grande quadrato piatto a copertura totale della piletta.
C.p. polished pop-up waste, 1" 1/4, luxury type with big squared flat plug covering the drain.

**A900PL**

Scarico automatico in plastica, 1"1/4
Plastic pop-up waste, 1"1/4

**A900TA**

Tappo scarico automatico per piletta 1", 1"1/4.
Plug for pop-up waste for drain 1", 1"1/4.

**A900TAS**

Tappo grande quadrato in ottone cromato per scarico automatico con piletta da 1"1/4.
Squared big plug in c.p. brass for pop-up waste with drain 1"1/4.

**A902TA**

Tappo grande in ottone cromato per scarico automatico con piletta da 1"1/4.
Big plug in c.p. brass for the pop-up waste with drain 1"1/4.

**A630**

Nipples completo con guarnizione in gomma, ranella e anello tagliato in ottone, 3/8x10 - 1/2x10.
C.p. double nipple with nut and 3 pcs washers, 3/8x10 - 1/2x10.

**A630L**

Nipples prolungato completo con guarnizione in gomma, ranella e anello tagliato in ottone, 1/2 x 10 mm.
Extended c.p. double nipple with nut and 3 pcs washers, 1/2 x 10 mm.

**A630D**

Doppio nipples completo con guarnizioni in 3 pezzi, 3/8 x 10 x 10 x 10.
C.p. double nipple with nut and 3 pcs washers, 3/8 x 10 x 10.

**A630F**

Raccordo femmina completo con guarnizioni in 3 pezzi, 1/2 x 10 mm.
C.p. female connection, with nut and 3 pcs washers, 1/2 x 10.

BOX
INCASSO
BUILT-IN
BOXWELLNESS
KITCROMOTERAPIA
COLOUR
THERAPIESOFFIONI
SHOWER
HEADPANNELLI
DOCCIA
SHOWER
PANELSCOLONNE
DOCCIA
SHOWER
COLUMNSALISCENDI
SLIDING
RAILSDOCCETTE
HAND
SHOWERSOASIS
SHUT-OFFBOCCHE
SPOUTSACCESSORI
RUBINETTERIA
TAP
ACCESSORIES

ACCESSORI PER RUBINETTERIA - TAPS ACCESSORIES



A910

Confezione fissa water-bidet composta da 4 viti ottone, 4 dadi ottone, 4 sottoviti, 4 tasselli.
Bag for fixing WC-bidet: a brass screw, 4 caps, 4 under screws, 4 nuts.



A936 T1010

Raccordo a T con guarnizioni in gomma, ranelle e anelli tagliati in ottone, 10 x 10 x 10 mm.
Equal T connection, with 3 nuts and 3 pcs washers, 10 x 10 x 10 mm.



A936 M1210

Raccordo a gomito completo con guarnizione in gomma, ranella e anello tagliato in ottone, 1/2 x 10.
C.p. elbow with nut and 3 pcs washers, 1/2 x 10.



A936 1010

Raccordo a gomito con guarnizione in gomma, ranella e anelli tagliati in ottone, 10 x 10.
C.p. elbow with two nuts and 3 pcs washers, 10 x 10.



A905

Astina con pomolo e snodino per serie Eco.
Rod with knob and small joint for Eco series.



A906

Asta con pomolo e snodino.
Rod with knob and small joint.



A900AS30

Astina per scarico automatico, lunghezza cm 30, in ottone cromato.
Rod for automatic waste, length cm 30, in c.p. brass.



A980L

Tubo liscio Ø 10 in rame cromato con attacco filettato 10Mx1 lunghezza cm 40 e dado.
Cp copper pipe Ø 10 mm threaded 10Mx1 length cm 40 and nut.



A980FF

Tubo liscio in rame cromato Ø10 mm, con 2 cartelle e 2 dadi da 1/2, disponibile con dadi 3/8, cm 30, 40, 50, 60.
C.p. copper pipe Ø mm 10, with 2 nuts 1/2, available with nuts 3/8, cm 30, 40, 50, 60.



A980F

Tubo liscio Ø 10 mm in rame cromato, con cartella e dado da 1/2, disponibile con dado 3/8, cm 30, 40, 50, 60.
C.p. copper pipe Ø mm 10, with nut 1/2, available with nut 3/8, cm 30, 40, 50, 60.



A950 FF

Flessibile in treccia d'acciaio inox Ø14 con tubo interno in gomma alimentare.
 1/2Fx1/2F - 1/2Fx3/8F - 3/8Fx3/8F, cm 20, 25, 30, 35, 40, 50, 60, 80, 100.
Flexible hose in stainless steel Ø14 with internal in EPDM.



A950 MF

Flessibile in treccia d'acciaio inox Ø14 con tubo interno in gomma alimentare.
 1/2Mx1/2F - 1/2Mx3/8F - 3/8Mx3/8F, cm 20, 25, 30, 35, 40, 50, 60, 80, 100.
 1/2Mx1/2F - 1/2Mx3/8F - 3/8Mx3/8F, cm 20, 25, 30, 35, 40, 50, 60, 80, 100.

**A970**

Flessibile in treccia d'acciaio inox Ø12 per monocomandi con tubo interno in gomma alimentare.

M10x1 - M10x1/2F - M10x3/8F, cm 35, 45, 60, 90, 120, 150.

Flexible hose in stainless steel Ø12 for single-lever mixer, internal in EPDM.

M10x1 - M10x1/2F - M10x3/8F, cm 35, 45, 60, 90, 120, 150.

**A970L**

Flessibile in treccia d'acciaio inox Ø12 per monocomandi con tubo interno in gomma alimentare.

ML10x1 - ML10x1/2F - ML10x3/8F, cm 35, 45, 60, 90, 120, 150.

Flexible hose in stainless steel Ø12 for single-lever mixer, internal in EPDM.

ML10x1 - ML10x1/2F - ML10x3/8F, cm 35, 45, 60, 90, 120, 150.

**A971**

Flessibile in treccia d'acciaio inox Ø10 per monocomandi con tubo interno in gomma alimentare.

M8x1 - M8x1/2F - M8x3/8F, cm 35, 45, 60, 90, 120, 150.

Flexible hose in stainless steel Ø10 for single-lever mixer, internal in EPDM.

M8x1 - M8x1/2F - M8x3/8F, cm 35, 45, 60, 90, 120, 150.

**A990 FF**

Flessibile in treccia di acciaio inox gigante Ø 18 per scaldabagno, con tubo interno gomma alimentare EPDM.

1/2Fx1/2F - 1/2Fx3/4F - 3/4Fx3/4F, cm 25, 30, 35, 40, 50.

Flexible hose in stainless steel Ø 18 for water heater, internal in EPDM.

1/2Fx1/2F - 1/2Fx3/4F - 3/4Fx3/4F, cm 25, 30, 35, 40, 50.

**A990 MF**

Flessibile in treccia di acciaio inox gigante Ø 18 per scaldabagno, con tubo interno gomma alimentare EPDM.

1/2Mx1/2F - 1/2Mx3/4F - 3/4Mx1/2F - 3/4Mx3/4F.

cm 25, 30, 35, 40, 50.

Flexible hose in stainless steel Ø 18 for water heater, internal in EPDM.

1/2Mx1/2F - 1/2Mx3/4F - 3/4Mx1/2F - 3/4Mx3/4F.

cm 25, 30, 35, 40, 50.

BOX
INCASSO
BUILT-IN
BOX

WELLNESS
KIT

CROMOTERAPIA
COLOUR
THERAPIE

SOFFIONI
SHOWER
HEAD

PANNELLI
DOCCIA
SHOWER
PANELS

COLONNE
DOCCIA
SHOWER
COLUMN

SALISCENDI
SLIDING
RAILS

DOCCETTE
HAND
SHOWERS

OASIS
SHUT-OFF

BOCCHIE
SPOUTS

ACCESSORI
RUBINETTERIA
TAP
ACCESSORIES



ACCESSORI BAGNO BATH ACCESSORIE

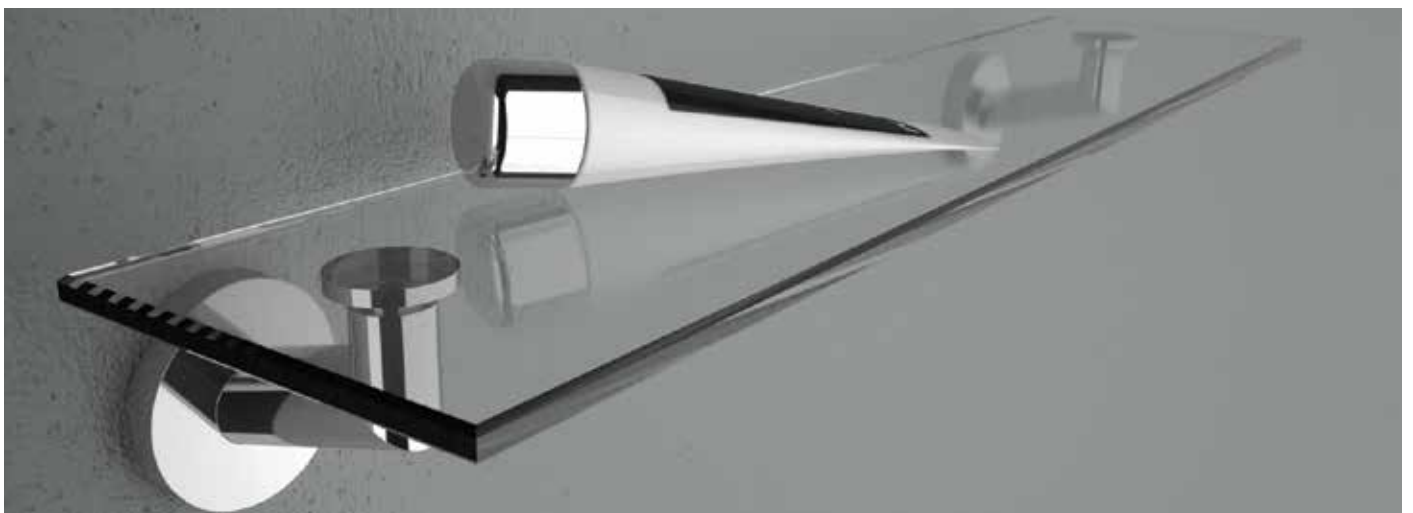



ACCESSORI BAGNO
BATH ACCESSORIES

TOKYO
STEEL

VOGUE

PARIS

WIRE

N.Y.C.



HILTON

REVIVAL

ACCESSORI
ACCESSORIES

IDROSCOPINI
HYDRO BRUSH



TOKYO STEEL



SSTXDIA954
 Dispenser in acciaio INOX spazzolato.
Brushed stainless steel dispenser.

STAINLESS
 STEEL



SSTXDI954
 Dispenser per sapone liquido da parete in ceramica con supporto tutto in acciaio INOX spazzolato.
Wall mounted soap dispenser with support all in brushed stainless steel.

STAINLESS
 STEEL



SSTXPBA940
 Bicchiere in acciaio INOX spazzolato.
Brushed stainless steel cup.

STAINLESS
 STEEL



SSTXPB940
 Portabicchiere da parete con bicchiere in acciaio INOX spazzolato.
Wall mounted cup holder with glass all in brushed stainless steel.

STAINLESS
 STEEL



SSTXPR911
Portarotolo in acciaio INOX spazzolato.
Brushed stainless steel toilet paper holder.



SSTXPRR920
Portarotolo di ricambio in acciaio INOX spazzolato.
Brushed stainless steel spare toilet paper holder.



SSTXPSA930
Portascopino in acciaio INOX spazzolato da pavimento.
Brushed stainless steel floor broom rack holder.



SSTXPS930
Portascopino in acciaio INOX da parete spazzolato.
Wall brushed stainless steel broom rack holder.



SSTXAP960
Appendino in acciaio INOX spazzolato.
Brushed stainless steel hook.



SSTXPS973CM30
Portasalviette in acciaio INOX spazzolato, lunghezza cm 30.
Brushed stainless steel towel holder, length cm 30.



SSTXPS975
Portasalviette in acciaio INOX spazzolato, lunghezza cm 60.
Brushed stainless steel towel holder, length cm 60.



VOGUE



VGDI954

Dispenser per sapone liquido in vetro con supporto in ottone cromato.
Glass soap dispenser with cp brass support.



VGPB940

Portabicchiere in ottone cromato con bicchiere in vetro.
Cp brass cup holder with glass.



VGPS950

Portasapone in vetro con supporto in ottone cromato.
Glass soap dish holder with cp brass support.



VGAP960

Appendino in ottone cromato.
Cp brass hook.



VGPR910
Portarotolo in ottone cromato.
Cp brass toilet paper holder.



VGPR911
Portarotolo in ottone cromato.
C.p. brass toilet paper holder.



VGME900
Mensola in ottone cromato.
Dimensione 13x51 cm.
Cp brass shelf.
Dimensions 13x51 cm.



VGPA970
Portasalviette in ottone
cromato, 23,6x70 mm.
Cp brass towel holder
23,6x70 mm.



VGPS973
Portasalviette in ottone
cromato, lunghezza cm 40.
Cp brass towel holder,
length cm 40.



VGPS975
Portasalviette in ottone
cromato, lunghezza cm 60.
Cp brass towel holder,
length cm 60.



VGPS978
Portasalviette doppio in ottone
cromato, lunghezza cm 60.
Cp brass double towel holder,
length cm 60.

TOKYO
STEEL

VOGUE

PARIS

WIRE

N.Y.C.

HILTON

REVIVAL

ACCESSORI
ACCESSORIES

RICAMBI - SPARE PARTS



ACGL950VG
Portasapone.
Soap holder.



ACGL954VG
Dispenser.
Dispenser.



ACGL940VG
Bicchiere.
Cup.

IDROSCOPINI
HYDRO BRUSH



PARIS



PAPB940
Portabicchiere.
Cup holder.



PAPS950
Portasapone.
Soap-dish holder.



PADI954
Dispenser.
Soap dispenser.



PAPA970
Portasalvietta ad anello.
Ring towel holder.



PAPS930
Portascopino.
Broom rack holder.



PAPR910
Portarotolo.
Toilet paper holder.



PAPR911
Portarotolo.
Toilet paper holder.



PAAP960
Appendino.
Hook.



PAME900
Mensola.
Glass shelf.



PAPS973
Portasalviette.
lunghezza cm 40.
Towel holder, length
cm 40.



PAPS975
Portasalviette da cm 60.
Towel holder cm 60.



PAKIT

Set serie Paris composto da 8 accessori:
- 2 portasapone
- 1 portabicchiere
- 1 portasalviette cm 60
- 1 portasalviette cm 40
- 1 portasalviette ad anello
- 1 appendino
- 1 portarotolo.

Set serie Paris composed of:
- 2 soap dish holder
- 1 cup holder
- 1 towel holder cm 60
- 1 towel holder cm 40
- 1 towel ring
- 1 hook
- 1 toilet paper roll holder

TOKYO
STEEL

VOGUE

PARIS

WIRE

N.Y.C.

HILTON

RICAMBI - SPARE PARTS



ACSC930PA
Scopino da bagno.
Toilet brush.



ACCE950PA
Porta sapone.
Soap Holder.



ACCE954PA
Dispenser.
Soap Dispenser.



ACCE940PA
Bicchiere.
Glass.

REVIVAL

ACCESSORI
ACCESSORIES

IDROSCOPINI
HYDRO BRUSH

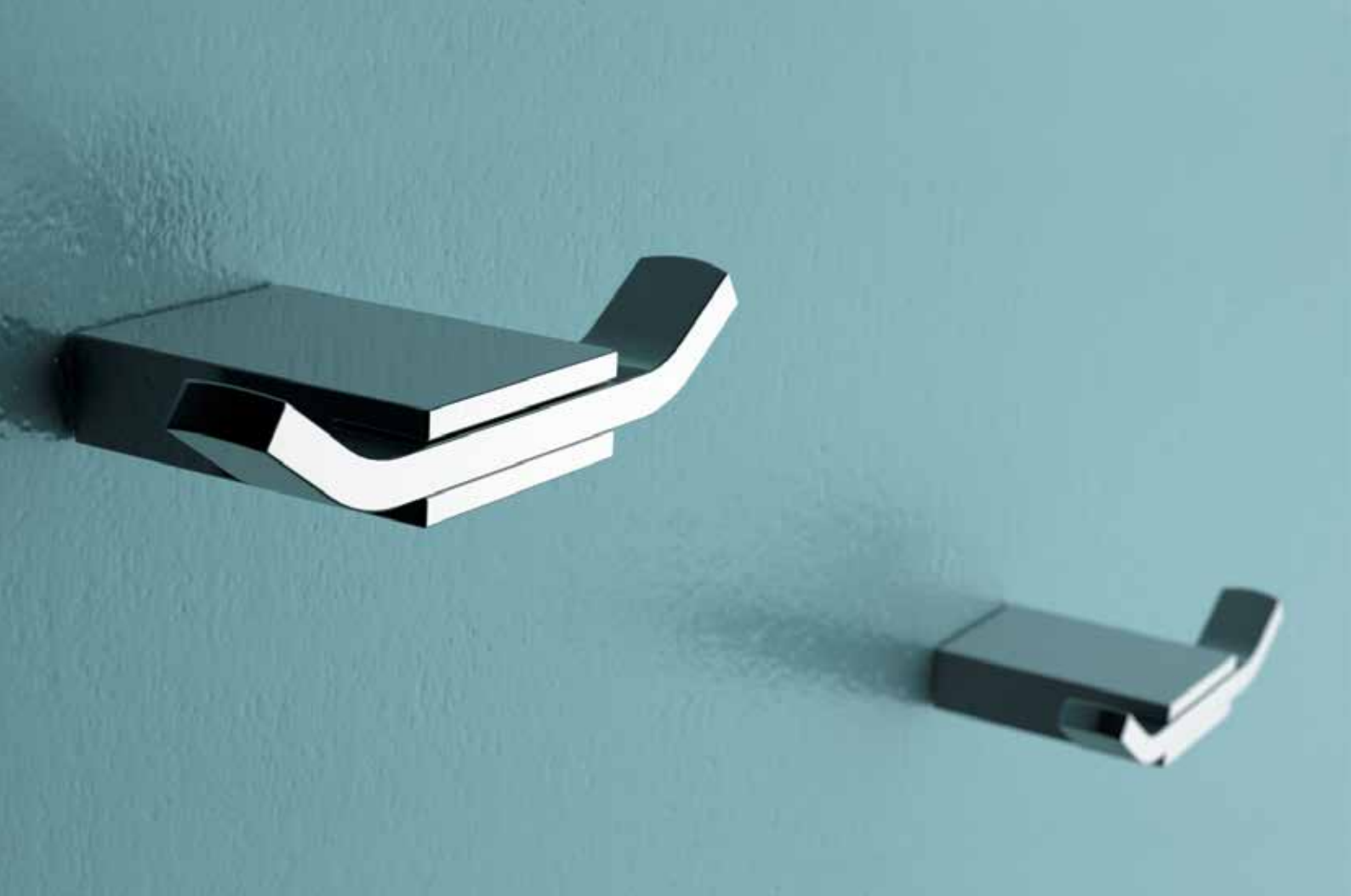

WIRE



WIPB940
Portabicchiere.
Cup holder.



WIDI954
Dispenser.
Soap dispenser.



WIAP960
Appendino doppio.
Double hook.



WIPS950
Portasapone.
Soap-dish holder.



WIPA970
Portasalviette ad anello.
Ring towel holder.



WIPS970
Portasalviette doppio.
Double towel holder.



WIPR910
Portarotolo.
Toilet paper holder.



WIPR911
Portarotolo.
Toilet paper holder.



WIPS930
Portascopino.
Broom rack holder.



WIME900
Mensola in vetro.
Glass shelf.



WIPS973
Portasalviette da cm 40.
Towel holder cm 40.



- WIKIT
Set serie Paris composto da 8 accessori:
- 2 portasapone
- 1 portabicchiere
- 1 portasalviette cm 60
- 1 portasalviette cm 40
- 1 portasalviette ad anello
- 1 appendino
- 1 portarotolo.

Set serie Paris composed of:
- 2 soap dish holder
- 1 cup holder
- 1 towel holder cm 60
- 1 towel holder cm 40
- 1 towel ring
- 1 hook
- 1 toilet paper rooll holder



WIPS975
Portasalviette da cm 60.
Towel holder cm 60.



WIPS978
Portasalviette doppio da cm 60.
Double bar towel holder cm 60.

TOKYO
STEEL

VOGUE

PARIS

WIRE

N.Y.C.

HILTON

REVIVAL

ACCESSORI
ACCESSORIES

IDROSCOPINI
HYDRO BRUSH

RICAMBI - SPARE PARTS



ACSC930WI
Scopino da bagno.
Toilet brush.



ACCE950WI
Porta sapone.
Soap Holder.



ACCE954NY
Dispenser.
Soap Dispenser.



ACCE940NY
Bicchiere.
Glass.

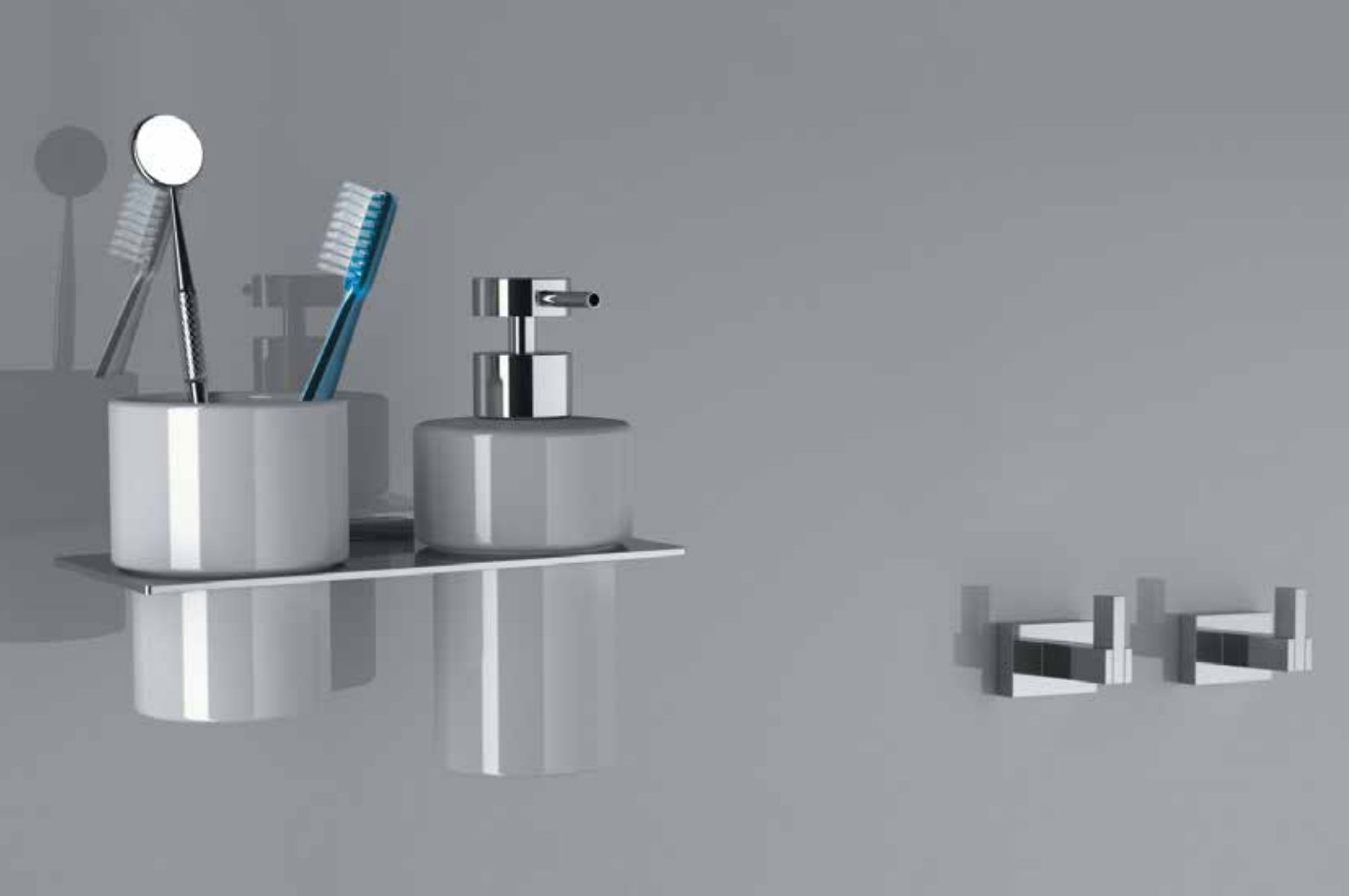

NEW YORK CITY



NYPB940
Portabicchiere.
Cup holder.



NYPB941
Portabicchiere doppio.
Double cup holder.



NYPBDI945
Portabicchiere con
dispenser.
*Cup holder with
dispenser.*



NYPS952
Portasapone.
Soap holder.



NYPS950
Portasapone.
Soap-dish holder.



NYDI954
Dispenser.
Soap dispenser.



NYPR910
Portarotolo.
Toilet paper holder.



NYPS930
Portascopino.
Broom rack holder.



NYPRR920
Portarotolo di ricambio.
Spare toilet paper holder.



NYAP960
Appendino.
Hook.



NYPA970
Portasalviette ad anello.
Ring towel holder.



NYME900
Mensola in vetro.
Glass shelf.



NYPS973
Portasalviette da cm 40.
Towel holder cm 40.



NYPS975
Portasalviette da cm 60.
Towel holder cm 60.



NYPS978
Portasalviette doppio da cm 60.
Double bar towel holder cm 60.



NYME901
Mensola doppia in vetro.
Double glass shelf.



- NYKIT

Set serie Paris composto da 8 accessori:
- 2 portasapone
- 1 portabicchiere
- 1 portasalviette cm 40
- 1 portasalviette cm 60
- 1 portasalviette ad anello
- 1 appendino
- 1 portarotolo.

Set serie Paris composed of:
- 2 soap dish holder
- 1 cup holder
- 1 towel holder cm 60
- 1 towel holder cm 40
- 1 towel ring
- 1 hook
- 1 toilet paper roll holder



NYPS980
Portasalviette quadruplo da cm 60.
Quadruple towel holder cm 60.

TOKYO
STEEL

VOGUE

PARIS

WIRE

N.Y.C.

HILTON

REVIVAL

RICAMBI - SPARE PARTS

ACCESSORI
ACCESSORIES



ACSC930WI
Scopino da bagno.
Toilet brush.



ACCE950NY
Porta sapone.
Soap Holder.



ACCE954NY
Dispenser.
Soap Dispenser.



ACCE940NY
Bicchiere.
Glass.

IDROSCOPINI
HYDRO BRUSH



HILTON



HIPB940
Portabicchiere.
Cup holder.



HIPB941
Portabicchiere doppio.
Double cup holder.



HIPBDI945
Portabicchiere con dispenser.
Cup holder with dispenser.



HIPS950
Portasapone.
Soap-dish holder.



HIPBPS942
Portabicchiere con portasapone.
Cup holder with soap dish holder.



HIPS952
Portasapone.
Soap holder.



HIDI954
Dispenser.
Soap dispenser.



HIPA970
Portasalviette ad anello.
Ring towel holder.



HIPR910
Portarotolo.
Toilet paper holder.



HIPRR920
Portarotolo di ricambio.
Spare toilet paper holder.



HIPRR922
Portarotolo di ricambio orizzontale.
Horizontal spare toilet paper holder.



HIAP960
Appendino.
Hook.



HIPS930
Portascopino.
Broom rack holder.



HIME900
Mensola in vetro.
Glass shelf.



HIPS978
Portasalviette doppio da cm 60.
Double bar towel holder cm 60.

TOKYO
STEEL

VOGUE



HIPS973
Portasalviette da cm 40.
Towel holder cm 40.



HIPS975
Portasalviette da cm 60.
Towel holder cm 60.

PARIS

WIRE

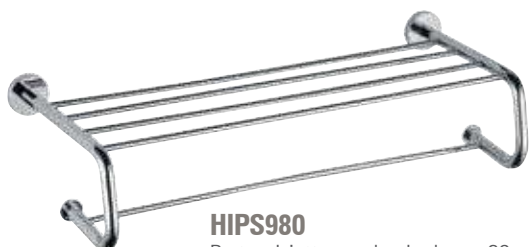

HIPS980
Portasalviette quadruplo da cm 60.
Quadruple towel holder cm 60.



- HIKIT

Set serie Paris composto da 8 accessori:

- 2 portasapone
- 1 portabicchiere
- 1 portasalviette cm 60
- 1 portasalviette cm 40
- 1 portasalviette ad anello
- 1 appendino
- 1 portarotolo.

Set serie Paris composed of:

- 2 soap dish holder
- 1 cup holder
- 1 towel holder cm 60
- 1 towel holder cm 40
- 1 towel ring
- 1 hook
- 1 toilet paper roll holder

N.Y.C.

HILTON

REVIVAL

RICAMBI - SPARE PARTS



ACSC930HI
Scopino da bagno.
Toilet brush.



ACCE950RE
Porta sapone.
Soap Holder.



ACCE954NY
Dispenser.
Soap Dispenser.



ACCE940NY
Bicchiere.
Glass.

ACCESSORI
ACCESSORIES

IDROSCOPINI
HYDRO BRUSH



REVIVAL

FINITURE DISPONIBILI - AVAILABLE FINISHINGS:



63 vecchio ottone
old brass



64 vecchio rame
old copper



NP nichel spazzolato
brushed nickel



CR cromo
chrome



REPB94063
Portabicchiere.
Cup holder.



REPS95063
Portasapone.
Soap-dish holder.



REPS95263
Portasapone.
Soap holder.



REAP96063
Appendino doppio.
Double hook.



REDI95463
Dispenser.
Soap dispenser.



REPS93063
Portascopino.
Broom rack holder.



REPA97063

Portasalviette ad anello.
Ring towel holder.



REPRR92063

Portarotolo di ricambio.
Spare toilet paper holder.



REPR91063

Portarotolo.
Toilet paper holder.



REME90063

Mensola in vetro.
Glass shelf.



REPS97363

Portasalviette da cm 40.
Towel holder cm 40.



REPS97563

Portasalviette da cm 60.
Towel holder cm 60.



REPS97863

Portasalviette doppio da cm 60.
Double bar towel holder cm 60.



REKIT

Set serie Paris composto da 8 accessori:

- 2 portasapone
- 1 portabicchiere
- 1 portasalviette cm 60
- 1 portasalviette cm 40
- 1 portasalviette ad anello
- 1 appendino
- 1 portarotolo.

Set serie Paris composed of:

- 2 soap dish holder
- 1 cup holder
- 1 towel holder cm 60
- 1 towel holder cm 40
- 1 towel ring
- 1 hook
- 1 toilet paper roll holder



REPS98063

Portasalviette quadruplo da cm 60.
Quadruple towel holder cm 60.

TOKYO
STEEL

VOGUE

PARIS

WIRE

N.Y.C.

HILTON

REVIVAL

RICAMBI - SPARE PARTS

ACCESSORI
ACCESSORIES



ACSC930HI

Scopino da bagno.
Toilet brush.



ACCE950RE

Porta sapone.
Soap Holder.



ACCE954RE

Dispenser.
Soap Dispenser.



ACCE940RE

Bicchiere.
Glass.

IDROSCOPINI
HYDRO BRUSH



ACCESSORI BAGNO BATH ACCESSORIES



A2211

Portasapone piccolo rettangolare.
Rectangular shaped soap holder, small.



A2212

Portasapone grande rettangolare.
Rectangular shaped soap holder, big.



A2271

Portasapone piccolo angolare.
Corner soap holder, small.



A2272

Portasapone grande angolare.
Corner soap holder, big.



A2281

Portasapone piccolo ovale.
Oval soap holder, small.



A2282

Portasapone grande ovale.
Oval soap holder, big.



A2273
Portasapone angolare.
Corner shaped soap holder.



A2277
Portasapone doppio angolare.
Corner double shaped soap holder.



A2312
Appendiabiti in linea a due ganci.
Clothes holder, two hooks.



A2313
Appendiabiti in linea a tre ganci.
Clothes holder, three hook.



A2310
Appendiabito a muro minimale.
Cp brass minimal hook.



A2440
Portasalviette da cm 40.
Towel holder bar, cm 40.



A2430
Portasalviette da cm 60.
Towel holder bar, cm 60.



A2470
Portasciugamano multiplo da cm 60.
Multiple towel holder bar, cm 60.



A2480
Maniglione vasca con portasapone.
Bathtub handler with soap holder.



A2496
Porta sacchetti igienici in ABS.
Tissue holder box in c.p. ABS.



A2490
Sistema filo stendibiancheria da hotel e di servizio, completo di contenitore, cavo e supporto a muro.
Clothes line sytem for hotel and service use, complete of cable, holder case and wall support.



A2495
Portasalviette.
Tissue holder box.



A2495A
Porta fazzoletti in ABS cromato.
Dimensioni: 25,5x14x6,5 cm.
*Tissue holder box in c.p. ABS.
Dimensions: 25,5x14x6,5 cm.*

TOKYO
STEEL

VOGUE

PARIS

WIRE

N.Y.C.

HILTON

REVIVAL

ACCESSORI
ACCESSORIES

IDROSCOPINI
HYDRO BRUSH

ACCESSORI BAGNO - BATH ACCESSORIES



A1030

Bilancia elettronica pesapersone, da 0,1 fino a 150 kg con possibilità risultato in kg o Lbs, pedana in cristallo temperato.

Electronic scale for family use, sharp from 0,1 till 150 kg possibility results in Kg or Lbs, with footplate in tempered crystal.



A1035

Bilancia elettronica pesapersone, da 0,1 fino a 150 kg con possibilità risultato in kg o Lbs, pedana in cristallo temperato.

Electronic scale for family use, sharp from 0,1 till 150 kg possibility results in Kg or Lbs, with footplate in tempered crystal.



A2465

Portascopino in ottone cromato.
Broom rack all in C.P. brass.



A1930

Portascopino in acciaio INOX.
Broom rack in stainless steel.



A1050

Dispenser per liquidi, con sistema di chiusura di sicurezza.
Soap dispenser, with security lock system.



A1060

Doppio dispenser per liquidi, con sistema di chiusura di sicurezza.
Double soap dispenser, with security lock system.



A1065BI

Doppio dispenser per liquidi con sistema di chiusura di sicurezza, tutto bianco.
Double soap dispenser for liquids, with security lock system, all white.



A2600

Dispenser per liquidi.
Soap dispenser for liquid.



A2550

Piantana portasciugamani a due posizioni.
Vertical towel holder with 2 arms.



A2550PS

Piantana con portasciugamani a due posizioni e portascopino.
Vertical towel holder with two arms and with broom rack.



A2560

Piantana con portasciugamani a due posizioni, portascopino e portarotolo.
Vertical towel holder with two arms, with broom rack and toilet paper holder.



A1001
Portarifiuti 3 litri.
Toilet bin 3 liters.



A1002
Portarifiuti 5 litri.
Toilet bin 5 liters.



A1003
Portarifiuti 12 litri.
Toilet bin 12 liters.



A1005
Portarifiuti rettangolare 5 litri.
Rectangular toilet bin 5 liters.

TOKYO
STEEL



A2635LTP
Specchio ingranditore retroilluminato, accensione al tocco, spegnimento automatico, a batteria. Ø 18 cm, estensione max 34 cm.
Magnifier backlighted mirror, power touch, automatic shutdown, battery powered. Ø 18 cm, maximum extension 34 cm.



A2636LTP
Specchio ingranditore retroilluminato, accensione al tocco, spegnimento automatico, a batteria. 18x18 cm, estensione max 34 cm.
Magnifier backlighted mirror, power touch, automatic shutdown, battery powered. 18x18 cm, maximum extension 34 cm.



VOGUE

PARIS

WIRE



A2635LCTP
Specchio ingranditore retroilluminato, con spina e interruttore. Ø 21,5 cm, estensione max 26 cm.
Magnifier backlighted mirror, power supply, and switch. Ø 21,5 cm, maximum extension 26 cm.



A2636LCTP
Specchio ingranditore retroilluminato, con spina e interruttore. 21x21 cm, estensione max 35 cm.
Magnifier backlighted mirror, power supply, and switch. 21x21 cm, maximum extension 35 cm.



N.Y.C.

HILTON



A2630
Specchio ingranditore a doppia faccia diametro 15 cm, attacco a muro e braccio snodabile.
Magnifier mirror, double side, diameter 15 cm, wall connection and adjustable arms.



A2635
Specchio ingranditore a doppia faccia diametro 21 cm, attacco a muro e braccio snodabile.
Magnifier mirror, double side, diameter 21 cm, wall connection and adjustable arms.

REVIVAL

ACCESSORI
ACCESSORIES



A2640
Specchio ingranditore a doppia faccia diametro 15 cm.
Magnifier mirror, double side, diameter 15 cm.



A2645
Specchio ingranditore a doppia faccia diametro 21 cm.
Magnifier mirror, double side, diameter 21 cm.

IDROSCOPINI
HYDRO BRUSH



IDROSCOPINI HYDRO BRUSH



A1515DC

Idroscopino a pulsante in ottone cromato, con impugnatura liscia 1/2".
C.P. brass hydro brush with plain handgrip, 1/2".



A1525DC

Idroscopino a pulsante quadrata, in ottone cromato, 1/2".
C.P. brass hydro brush, squared, 1/2".



A549

Rubinetto d'arresto squadrato, con supporto doccia in ottone cromato e presa acqua per flessibile con attacco conico.
C.p. brass squared angle valve with shower holder and water punch, for conical nut flexibles.



A548

Rubinetto d'arresto minimale tondo, con supporto doccia in ottone cromato e presa acqua per flessibile con attacco conico.
C.p. brass round minimalist angle valve with shower holder and water punch, for conical nut flexibles.



A1515

Set composto da: idroscopino, flessibile conico 120 cm metallizzato in PVC, rubinetto d'arresto minimale, con supporto doccia in ottone cromato e presa acqua.

Set composed of: hydro brush, PVC metallized conical flexible hose 120 cm, c.p. brass minimal angle valve with shower holder and water punch.



A1515C

Set composto da: idroscopino a pulsante, flessibile con attacco conico cm 120 in PVC con piattina cromata, rubinetto d'arresto minimale, con supporto doccia in ottone cromato e presa acqua.

Set composed of: hydro brush handshower, PVC in chrome flat conical flexible hose cm 120, c.p. brass minimal angle valve with shower holder and water punch.



TOKYO
STEEL

VOGUE



A1525

Set composto da: idroscopino, flessibile conico 120 cm metallizzato in PVC, rubinetto d'arresto squadrato, con supporto doccia in ottone cromato e presa acqua per flessibile con attacco conico.

Set, composed by: hydro brush, PVC metallized conical flexible hose 120 cm, c.p. brass squared angle valve with shower holder and water punch.



A1525C

Set composto da: idroscopino a pulsante, flessibile con attacco conico cm 120 in PVC con piattina cromata, rubinetto d'arresto squadrato, con supporto doccia in ottone cromato e presa acqua per flessibile con attacco conico.

Set composed of: hydro brush handshower, PVC in chrome flat conical flexible hose cm 120, c.p. brass squared angle valve with shower holder and water punch.



PARIS

WIRE

N.Y.C.



A1515TEM

Set composto da: idroscopino a pulsante in ottone cromato, flessibile conico cm 120, rubinetto temporizzato 1/2" in ottone cromato, tempo d'apertura 6-8 secondi.

Set composed by: hydro brush in c.p. brass, flexible cm 120, temporized button flusher 1/2" all in c.p. brass, opening time 6-8 seconds.

HILTON

REVIVAL

ACCESSORI
ACCESSORIES

IDROSCOPINI
HYDRO BRUSH

ESPOSITORI - DISPLAYERS

ESPOSITORI DA PAVIMENTO - FLOOR DISPLAYERS



ESPSLIMB



ESPQD2



ESPQD



ESPFB

ESPOSITORE PER RUBINETTERIA AMBIENT - AMBIENT MIXERS DISPLAYER



ESP AMB



ESP0MT618

Rubinetto con tecnologia Touch-Me da esposizione e dimostrazione. Utilizzabile in mancanza di possibilità di collegamento del rubinetto Touch alla rete idrica, questa versione DEMO simula esattamente, toccando il miscelatore, l'apertura e chiusura dell'acqua tramite l'accensione e spegnimento di una luce azzurra posizionata in maniera molto visibile nella zona aeratore.

L'articolo è rilavorato per essere esclusivamente dimostrativo.

Faucet with Touch-Me technology for demonstration purpose.

In all the situations where it's not possible to connect the Touch faucet to the water supply, this DEMO version can simulate, when touching the mixer, the exact on/off of the water by turning on/off a blue light positioned in a very visible area by the aerator.

The item is reprocessed for demonstration only.

ESPOSITORE DA PARETE - WALL DISPLAYER



ESPACVERT



ESPAC

CONDIZIONI GENERALI DI VENDITA - SALE CONDITIONS

Accettazione ordini: La commissione è sempre subordinata all'approvazione della Casa Venditrice. Le condizioni di vendita si intendono accettate dal committente al momento del conferimento dell'ordine e con il ritiro del materiale.

Consegne e Rese: La merce è resa franco deposito di partenza e viaggia a rischio e pericolo del committente. Il venditore si riserva di poter effettuare consegne parziali.

Spedizioni: Le quantità devono essere verificate all'atto del ricevimento ed eventuali discordanze vanno annotate sulla bolla di consegna mediante accettazione "con riserva". Eventuali spese aggiuntive per giacenze sono a carico del committente.

Imballaggio: L'imballaggio è effettuato con imballi standard ed eventualmente su pallets a carico del committente.

Termini di consegna: I termini di consegna, eventualmente indicati, sono sempre forniti a puro titolo indicativo e non vincolante.

Prezzi: I prezzi riportati nei listini non sono vincolanti. La Daniel Rubinetterie S.p.A. si riserva la facoltà di variare i prezzi di vendita in qualsiasi momento senza nessun preavviso.

Pagamenti: L'eventuale ritardo del pagamento comporterà l'addebito di interessi al tasso corrente. La Daniel Rubinetterie S.p.A. si riserva la facoltà di sospendere eventuali ordini in corso in presenza di pagamenti irregolari.

Le contestazioni di qualsiasi valore o entità non danno diritto alla sospensione dei pagamenti.

Reclami: Non si accettano reclami o resi merce dopo 7 giorni dal ricevimento della stessa. I reclami devono pervenire entro i termini indicati tramite lettera raccomandata e via fax. Ogni reso deve essere preventivamente autorizzato dalla Daniel Rubinetterie S.p.A. che fornirà istruzioni in merito.

Caratteristiche tecniche: La Daniel Rubinetterie S.p.A. si riserva la facoltà di apportare ogni variazione agli articoli senza nessun preavviso.
Riservato dominio: I prodotti rimangono di proprietà della Daniel Rubinetterie S.p.A. fino al totale pagamento del prezzo in conformità a quanto previsto dal C.C.

Responsabilità: La Daniel Rubinetterie S.p.A. non fornisce garanzie circa l'impiego errato o inadatto dei propri prodotti. Qualora il materiale risultasse difettoso per vizi di fabbricazione riconosciuti a seguito di perizia, la Daniel Rubinetterie S.p.A. si riserva di sostituirlo o accreditarne il valore senza che la propria responsabilità si possa estendere in nessun caso ad altri oneri.

Foro: Per qualsiasi controversia il Foro competente è quello di Milano.

Orders acceptance: The order is always subject to approval by the seller.

Delivers: The goods are delivered Ex Works and travel at the buyer's own risk. The seller reserves the right to execute partial consignments. Forwarding: The quantities must be checked on receipt of the goods and any complaint must be made to the carrier. Any additional cost applied by the carrier will be charged to the buyer.

Packing: The goods are packed in standard packing on pallets charged to the customer.

Delivery terms: The delivery terms are always given as information and they never have to be considered as binding.

Prices: The prices shown on price list are not bending. Daniel Rubinetterie S.p.A. reserves the right to modify the sales prices in any time with no prior warning.

Payments: Interest at the current rate will be charged for any delays in payment. Daniel Rubinetterie S.p.A. reserves the right to delete any order on hand if the payments are not correct. Any complaint of whatever type or value do not give the right to suspend payments.

Complaints: Complaints and returned goods cannot be accepted after a period of 7 days from the arrival of the goods. Complaints must be made by mean of a registered letter or by fax within the terms stated. Any return of the goods must be authorized in advance by Daniel Rubinetterie S.p.A. with instructions about it.

Technical specifications: Daniel Rubinetterie S.p.A. reserves the right to carry out technical and aesthetical changes without previous notice. Lien: The products remain the property of Daniel Rubinetterie S.p.A. until the cost has been paid in full, in accordance with the provisions of the C.C.

Liability: Daniel Rubinetterie S.p.A. does not provide a guarantee covering the incorrect or the inappropriate use of its products. If the material should be substandard owing to manufacturing faults which are technical inspections, Daniel Rubinetterie S.p.A. reserves the right to replace the material or to credit the value to the buyer. However under no circumstance does the company's liability extend to the payment of direct or indirect charges for other things.

Competent Court of Law: For any controversy that may arise the competent court of law is the one of Milan.

DANIEL
RUBINETTERIE
MILANO

Daniel Rubinetterie S.p.A.
Via L. da Vinci, 53 - 20062 Cassano d'Adda - (MI) Italy
Tel.: +39 0363 62 651 - Fax: +39 0363 62 664
E-Mail: info@daniel.it - www.daniel.it



MADE IN ITALY