



MARRINER

R U B I N E T T E R I E

INCREDIBLY CREATIVE



Our range of products



Seve



Voyager



Perle



Eau de Mariner



Ibis



Dyno



Galileo



Vision



Energy



Kepler



Moon



Quadra



Fashion



Magica



Oka



Shadow



Cosmo



Alta



Divina



Gemma



Athena



Cheope



Extra



Camelot



Kitchen

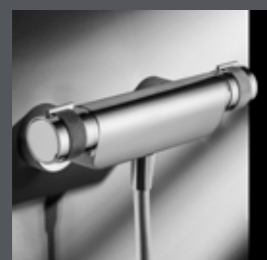

Thermomix

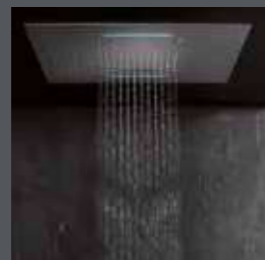

Wellness



Accessori Bagno



Index

2	About us
6	Factory
10	Quality
14	Our Values
20	Customizations
22	Products
22	Seve
30	Voyager
38	Perle
44	Eau de Mariner
50	Ibis
54	Dyno
60	Energy
70	Galileo
78	Quadra
86	Magica
94	Vision
98	Kepler
102	Moon
108	Fashion
116	Divina
118	Oka
122	Gemma
124	Alta
128	Shadow
130	Cosmo
132	Athena
138	Cheope
146	Extra
154	Camelot
160	Frankfurt
164	Kitchen
174	Thermomix
188	Wellness
206	Accessori Bagno

8055-010 VOYAGER

Batteria lavabo monoforo in ottone cromato con dosa-sapone in vetro temperato blu, con scarico automatico.

Chromed brass mono basin mixer with automatic pop-up waste and tempered blu glass soap dispenser.

 Ottavio Zennaro

Alla ricerca di linee e volumi in grado di interpretare in qualsiasi momento le mutevoli tendenze della moda e della società. Ancora una volta, è il linguaggio delle emozioni che comunica attraverso il design e ispira l'azienda a presentare nuovi prodotti in grado di trasmettere qualcosa di diverso agli ambienti quotidiani. La cura data alle finiture e la grande attenzione ai dettagli puntano all'impegno dell'azienda di produrre prodotti di design senza sacrificare l'efficienza e le funzionalità che sono sempre state le sue caratteristiche.

In search of lines and volumes able to interpret at any time the changing trends of fashion and society. Once again, it is the language of emotions that communicates through design and inspires the company to present new products able to convey something different to everyday environments. The care given to finishes and the great attention to detail all point to the company's commitment to making designer products without sacrificing the efficiency and functional features that have always been its hallmarks.





Ottavio Zennaro e il figlio Marino fondano l'azienda
The Company was founded by Ottavio Zennaro and the son Marino

1982



Nasce il brand Mariner Rubinetterie
Launching of Mariner Rubinetterie brand

1984



Acquisto primo tornio Transfer Gozio
First turning machine Transfer Gozio

1987



Nasce la serie Athena
Athena's range was launched

1991



Prima presenza al CERSAIE Bologna
Debut at CERSAIE Bologna

1993



Introduzione di macchinari innovativi
Introduction of innovative machineries

2005



Restyling logo
Logo's restyling

2010



La terza generazione fa il suo ingresso in azienda con Riccardo
Riccardo, third generation joins the company

2016



Prima sede produttiva di Omegna (VB)
First manufacturing site in Omegna (VB)

1983



Ampliamento sede produttiva Briga Novarese
Expansion of production site in Briga Novarese

1985



Rivisitazione logo
Restyling logo

1990



Prima fiera ISH Frankfurt
First appearance at ISH Frankfurt

1991



Presentazione serie Seve
Seve was introduced

1993



Costruzione nuovo capannone a Gravellona Toce (VB)
New headquarter in Gravellona Toce (VB)

1997



Lancio serie Voyager
Voyager was born

2006



Restyling del brand Mariner
Latest version of Mariner's brand

2017



MARINER
RUBINETTERIE
INCREDIBLY CREATIVE

Fondata agli inizi degli anni '80, abbiamo fatto di Mariner rubinetterie un'intuizione vincente: creare all'interno del "Distretto del Cusio" a Gravellona Toce (VB) una rubinetteria italiana ad elevato contenuto tecnologico che legasse tradizione, artigianalità e ricerca.

Founded in the early 1980's, Mariner made a winning intuition: creating within the "District of Cusio", in Gravellona Toce (VB) an Italian tap's manufacturer with high technological content that links tradition, craftsmanship and research.





M Production

Seguiamo attentamente l'intera filiera produttiva per garantire il massimo della qualità ai nostri clienti.

We carefully follow the whole supply chain



Foundry



Melted Pieces



Turning



Polishing



Galvanic



Test and Assembly

2301-010 OKA

Miscelatore vasca in ottone cromato con
deviatore automatico.

*Chromed brass bath bath shower mixer
with automatic diverter.*



M Quality

Scegliamo con cura i materiali con i quali realizzare i nostri prodotti, per garantire al cliente il meglio possibile per la salute ed il rispetto dell'ambiente. La scelta di materiali di alta qualità, lo spessore della cromatura, e l'esperienza nella produzione artigianale di alta gamma tipica della produzione **"made in Italy"**, sono le caratteristiche che permettono di installare i nostri rubinetti anche in ambienti ad alto indice di usura.

*We carefully choose the materials to realize our products, to guarantee the customer the best possible for health and respect for the environment. The choice of high quality materials, the thickness of the chrome plating, and the experience in high-end artisan production typical of **"made in Italy"** production, are the characteristics that allow us to install our faucets even in environments with a high wear index.*





7550-010 EXTRA
Monoforo lavabo interamente in ottone con scarico automatico.
Chromed brass basin mixer with automatic pop-up waste.

Warranty & Insurance

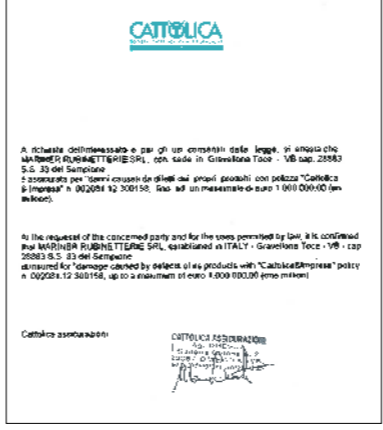

Testimonianza dei valori e della qualità dei prodotti sono le certificazioni internazionali (ISO 9001:2008) che abbiamo ottenuto per lavorare nei diversi mercati (SITAC Scandinavia, CSA Stati Uniti, NSF-WRc Regno Unito). Questa impostazione strategica ci consente di vantare progetti prestigiosi. Lavoriamo a stretto contatto con aziende che condividono la nostra vision ed il nostro standard di qualità seguendo l'intera filiera, per fornire un design ispirato ed una qualità senza eguali. Crediamo che un rapporto a lungo termine, redditizio e di successo, si fonda sulla fiducia, sull'empatia e sulla comprensione reciproca.

Testimonials of the values and quality of the products are the international certifications (ISO 9001: 2008) obtained to work with different markets (SITAC Scandinavia, CSA United States, NSF-WRc United Kingdom). This strategic approach allows us to boast of prestigious projects. We work closely with companies that share our vision and our quality standards throughout the whole chain to provide inspired design and unmatched quality. We believe that a long-term, profitable and successful relationship is based on trust, empathy, and mutual understanding.

Certifications

WRAS APPROVED PRODUCT

This certifies that **MARINER RUBINETTERIE SRL** has had the undermentioned product examined, tested and found, when correctly installed, to comply with the requirements of the United Kingdom Water Supply (Water Fittings) Regulations and Scottish Water Byelaws.

1361 COMBINATION TAP ASSEMBLIES

BUREAU VERITAS Certification

MARINER RUBINETTERIE SRL

Head Office and Operative Site:
Strada Statale 33 del Sempione - 28883 GRAVELLONA TOCE (VB) - ITALY

Bureau Veritas Italia spa certify that the Management System of the above organisation has been audited and found to be in accordance with the requirements of the management system standards detailed below

THIS IS TO CERTIFY THAT

Mariner Rubinetteria

has had the following products Certified by Buildcert Limited to the requirements of:

BS EN 1111:1999 Thermostatic Mixing Valves (High Pressure)¹⁾²⁾

Products covered by this certification include:

1316A Thermostatic Bath Shower Mixer

Approved Designation of use: HP-S & HP-T suitable for bath fill with hydraulic resistance D suitable for shower fill with hydraulic resistance A

BUILDCERT



8080-VOYAGER

Rubinetto lavello monoforo interamente in ottone cromato con dosasapone in vetro e bocca alta girevole.
Single-hole sink tap made entirely of chromed brass with glass soap dispenser and high rotating spout.

Design

La creatività del design "made in Italy" ci ha consentito di realizzare rubinetteria anche di dimensione contenute, le soluzioni di design come il porta sapone applicato direttamente al rubinetto rappresentano un esempio di eleganza e praticità unite in unico progetto.

The creativity of "made in Italy" design has allowed us to create taps, even of small size, design solutions such as the soap holder applied directly to the tap are an example of elegance and practicality combined in a single project.



8650-010-450 SEVE

Rubinetto lavabo monoforo in resina Summer Sky con scarico click-clack.
Summer Sky mono basin mixer with click-clack waste.



Craftwork Care

We care about our products as if they were jewelry.

L'attenzione ai dettagli, la cura nella scelta dei materiali ed il costante controllo artigianale dei vari passaggi di produzione garantiscono un prodotto finale di alta qualità.

Attention to details, careful selection of materials and constant control of the various production steps guarantee a high quality final product.





6250-010 ENERGY

Miscelatore lavabo interamente in ottone con scarico automatico.
Allungabile tramite le prolunghe da 50 - 100 -150 - 200 mm per adattarlo
ad ogni tipo di installazione.

*Chromed brass mono basin mixer with automatic pop-up waste.
Extensible through extensions of 50 - 100 -150 - 200 mm for any kind of
installation.*

Water Saving

Un piccolo gesto può fare una grande differenza. L'acqua è il bene più prezioso che abbiamo, ed anche il più sprecato. Il risparmio dell'acqua non significa solo chiudere il rubinetto, ma anche limitare l'erogazione senza rinunciare ad un flusso corposo. Le nuove tecnologie danno la possibilità, con un minimo impegno, di ottenere grandi risultati.

A little act can make a big difference. Water is the most valuable patrimony we have, and even the most wasted. Water saving does not just mean closing the tap, but also limiting water outlet without sacrificing full flow. New technologies give the opportunity, with minimal effort, to achieve great results.





Customizable

Possiamo personalizzare i nostri prodotti per uniformarli allo stile della barca. Incisione laser, finiture metalliche, wrapping e maniglie di materiali alternativi sono solo alcune delle possibilità offerte.

We can customize our products to uniform them to the style of the boat. Laser engraving, metallic finishes, wrapping and handles of alternative materials are just some part of the possibilities offered.



8650-010-460 SEVE

Miscelatore lavabo in ottone con leva joystick, corpo in finitura legno naturale impermeabilizzato o in resina colorata. Con scarico click-clack
Brass mono basin mixer with joystick lever, body finish in natural waterproofed wood or colored resin. With click-clack waste



8650-010-450



Miscelatore monocomando lavabo in ottone cromato con guscio in resina bianca "Glacier White". Leva con cartuccia joystick. Con scarico click clack.

Single lever basin mixer, chromed brass finishes, "Glacier White" resin body. Joystick cartridge, click-clack waste

8660-010-450



Miscelatore monocomando bidet in ottone cromato con guscio in resina bianca "Glacier White". Leva con cartuccia joystick. Con scarico click clack.

Single lever bidet mixer, chromed brass finishes, "Glacier White" resin body. Joystick cartridge, click-clack waste

8601-010-450



Miscelatore monocomando vasca in ottone cromato con guscio in resina bianca "Glacier White". Leva con cartuccia joystick. Con deviatore automatico.

Single lever bath mixer, chromed brass finishes, "Glacier White" resin body. Joystick cartridge. Automatic diverter

8610-010-450



Miscelatore monocomando esterno doccia in ottone cromato con guscio in resina bianca "Glacier White". Leva con cartuccia joystick.

Single lever wall shower mixer, chromed brass finishes, "Glacier White" resin body. Joystick cartridge.

8640-010-450



Miscelatore monocomando incasso doccia in ottone cromato con piastra in resina bianca "Glacier White".

Single lever built-in shower mixer, chromed brass finishes, "Glacier White" resin body.



Materiale legno

Il legno che si utilizza per il rubinetto può essere di diversi tipi: "Naturale" e "Paglia" vengono ricavate dal legno di acero successivamente verniciati con prodotti particolari per dare la colorazione giusta
 "Noce" ottenuta dal legno di noce
 "Wengè" ottenuta dal legno wengè.
 Qualsiasi tipologia di legno utilizzata viene successivamente trattata in modo da creare una impermeabilizzazione che permette al rubinetto di durare nel tempo senza rovinarsi.

Wood material

The choice wood for the SEVE tap can be of various types: "Natural" and "Straw" finishes are based on maple wood, which is varnished with special products to obtain the right colour; "Walnut" finish is obtained from walnut wood; "Wengé" finish is obtained from wengé wood.
All wood types used are subsequently waterproofed to guarantee long-lasting taps, whose features do not alter in time.



8650-010-461
 Legno Wengé
 Wengé wood



8650-010-462
 Legno Paglia
 Straw wood



8650-010-460
 Legno Naturale
 Natural wood



8650-010-451
 Resina Peach
 Peach resin



8650-010-440
 Resina Arancione
 Orange resin



8650-010-450
 Resina Glacier White
 Glacier white resin

Materiale resina.

Si utilizza la resina poliesteri che è una particolare tipologia di resina termoindurente per colata che viene poi sagomata attraverso delle lavorazioni meccaniche. Tale materiale rende la superficie del prodotto brillante. Essendo di natura vetrosa non assorbe l'unto e grazie alla perfetta levigatura della superficie dona al rubinetto una lucentezza particolare che dura nel tempo.

Resin material.

Polyester Resin is the choice. This special type of thermosetting resin is first poured and the moulded through mechanical processing. This material yields brilliant product surfaces. Its vitreous properties prevent it from absorbing grease, while the perfectly smooth surface enhances the tap with special long-lasting brightness.

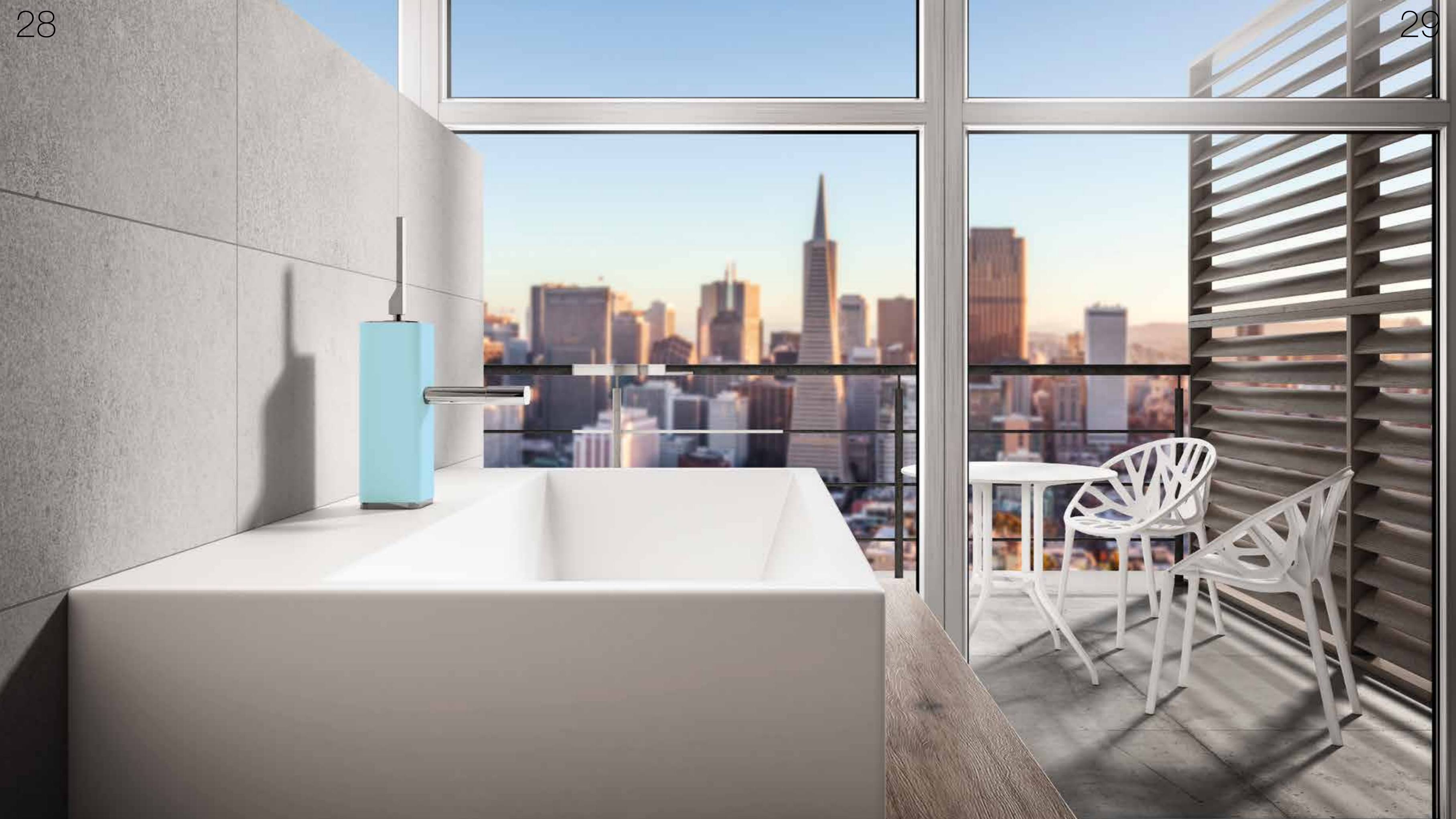



8055-010



Gruppo lavabo monoforo in ottone cromato con dosapone in vetro temperato blu, con scarico automatico.

Single hole basin mixer, chromed brass finishes. With automatic pop-up waste and blue tempered glass soap dispenser

8020-010



Batteria lavabo 3 fori in ottone cromato con scarico automatico.

3-holes basin group, chromed brass finishes. With automatic pop-up waste

8056-010



Gruppo lavabo incasso in ottone cromato con bocca da 165mm. Scarico click-clack.

Wall mounted basin mixer, chromed brass finishes. With 165 mm spout. Click clack waste

8058-010

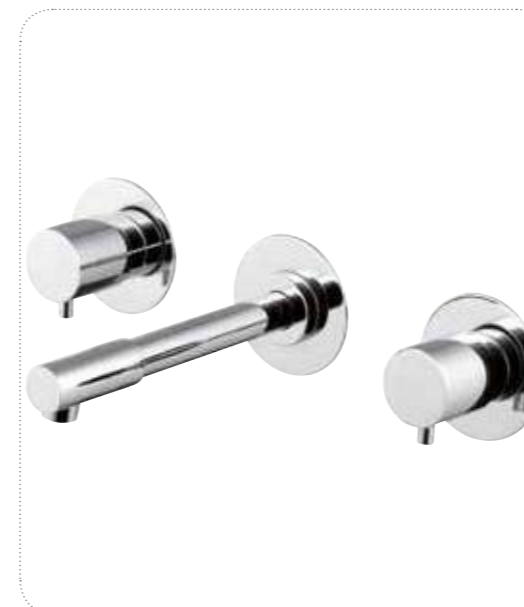

Gruppo lavabo incasso in ottone cromato con bocca da 165mm. Scarico click-clack.

Wall mounted basin mixer, chromed brass finishes. With 165 mm spout. Click clack waste

8046-010



Gruppo bidet monoforo in ottone cromato con dosapone vetro temperato blu, con scarico automatico.

Single hole bidet mixer, chromed brass finishes. With automatic pop-up waste and blue tempered glass soap dispenser

8025-010



Batteria bidet 3 fori in ottone cromato con scarico automatico.

3-holes basin group, chromed brass finishes. With automatic pop-up waste

8001-010



Gruppo vasca in ottone cromato con deviatore automatico

Wall mounted bath mixer, chromed brass finishes. With automatic diverter

8010-010



Gruppo doccia a parete in ottone cromato

Wall mounted shower mixer, chromed brass finishes

8015-010



Gruppo doccia incasso in ottone cromato con deviatore 2 vie

Built-in shower mixer, chromed brass finishes with diverter 2 ways.

8016-010



Gruppo doccia incasso in ottone cromato con deviatore 3 vie

Built-in shower mixer, chromed brass finishes with diverter 3 ways.

8000-010



Gruppo bordo vasca in ottone cromato completo di doccetta minimal tonda, e deviatore.

Deck mounted bath mixer, chromed brass finishes. With minimal round shower kit.

Bocca 1



Bocca a cascata a spigolo in acciaio inox con uscita acqua aperta

Built-in stainless steel waterfall jet bathtub filling mouth





M Voyager- bathroom

Sorprende la forma insolita del lavabo che accoglie il dosa-sapone. Ideale per lasciare libero il piano del lavabo, ma elegante e insolito anche in ambienti dove lo spazio non è un problema.

Unusual shape of the tap that includes the soap dispenser. Ideal to leave free the top of washbasin, but elegant and original, even where space is not a problem.



...-010
Cromo • Chrome



...-018
Satinato • Satin



...-084
Nero Opaco • Mat Black



...-014
Bronzo • Bronze



...-013
Oro • Gold



 Perle

7251-010-200



Miscelatore monocomando lavabo in ottone cromato con guscio in "White Pearl" perla con scarico automatico.

Single lever basin mixer, chromed brass finishes, "White Pearl" resin body, automatic pop-up-waste

7261-010-200



Miscelatore monocomando bidet in ottone cromato con guscio in resina "White Pearl". Con scarico automatico.

Single lever bidet mixer, chromed brass finishes, "White Pearl" resin body, automatic pop-up-waste

7201-010-200



Miscelatore monocomando vasca in ottone cromato con guscio in resina "White Pearl". Con deviatore automatico.

Single lever bath mixer, chromed brass finishes, "White Pearl" resin body with automatic diverter

7210-010-200



Miscelatore monocomando esterno doccia in ottone cromato con guscio in "White Pearl" perla.

Single lever wall shower mixer, chromed brass finishes, "White Pearl" resin body

7240-010-200



Miscelatore monocomando incasso doccia in ottone cromato con piastra in "White Pearl" perla.

Single lever built-in shower mixer, chromed brass finishes, "White Pearl" resin body



M Perle - colours

Materiale resina.

Si utilizza la resina poliestere che è una particolare tipologia di resina termoindurente per colata che viene poi sagomata attraverso delle lavorazioni meccaniche. Tale materiale rende la superficie del prodotto brillante. Essendo di natura vetrosa non assorbe l'unto e grazie alla perfetta levigatura della superficie dona al rubinetto una lucentezza particolare che dura nel tempo.

Resin material.

Polyester Resin is the choice. This special type of thermosetting resin is first poured and the moulded through mechanical processing. This material yields brilliant product surfaces. Its vitreous properties prevent it from absorbing grease, while the perfectly smooth surface enhances the tap with special long-lasting brightness.



7251-010-200
Resina Perla
Pearl resin



7251-010-202
Resina Bianco
White resin



7251-010-201
Resina Nero
Black resin



7251-010-205
Resina Rosso
Red resin



7251-010-203
Resina Blu
Blue Resin



 Eau de Mariner

7350-010-205



Miscelatore monocomando lavabo in ottone cromato con guscio in resina rosso perlato, scarico automatico.

Single lever basin mixer, chromed brass finishes, red pearl resin body, automatic pop-up-waste

7360-010-205



Miscelatore monocomando bidet in ottone cromato con guscio in resina rosso perlato, scarico automatico.

Single-lever bidet mixer, chromed brass, red pearl resin shell, automatic pop-up-waste

7301-010-205



Miscelatore monocomando vasca in ottone cromato con guscio in resina rosso perlato. Con deviatore automatico.

Mono bath mixer, chromed brass, red pearl resin shell, with automatic diverter

7310-010-205



Miscelatore monocomando esterno doccia in ottone cromato con guscio in resina rosso perlato.

Wall mono shower mixer, chromed brass, red pearl resin shell

7340-010-205



Miscelatore monocomando incasso doccia in ottone cromato con piastra in resina rosso perlato.

Built-in mono shower mixer, chromed brass, red pearl resin shell



M Eau de Mariner- colours

Materiale resina.

Si utilizza la resina poliestere che è una particolare tipologia di resina termoindurente per colata che viene poi sagomata attraverso delle lavorazioni meccaniche. Tale materiale rende la superficie del prodotto brillante. Essendo di natura vetrosa non assorbe l'unto e grazie alla perfetta levigatura della superficie dona al rubinetto una lucentezza particolare che dura nel tempo.

Resin material.

Polyester Resin is the choice. This special type of thermosetting resin is first poured and the moulded through mechanical processing. This material yields brilliant product surfaces. Its vitreous properties prevent it from absorbing grease, while the perfectly smooth surface enhances the tap with special long-lasting brightness.



7350-010-200
Resina Perla
Pearl resin



7350-010-202
Resina Bianco
White resin



7350-010-201
Resina Nero
Black resin



7350-010-205
Resina Rosso perlato
Red resin



7350-010-203
Resina Blu
Blue resin



8550-010



Batteria lavabo monoforo in ottone cromato con scarico automatico.

Single hole basin group, chromed brass finishes. With automatic pop-up waste

8520-010



Batteria lavabo 3 fori in ottone cromato con bocca girevole, scarico automatico

3-holes basin group, chromed brass finishes. With automatic pop-up waste

8545-010



Batteria bidet monoforo in ottone cromato con scarico automatico.

Single hole bidet group, chromed brass finishes. With automatic pop-up waste

8540-010



Batteria bidet 3 fori in ottone cromato con bocca girevole, scarico automatico

3-holes bidet group, chromed brass finishes. With automatic pop-up waste

8501-010



Gruppo vasca in ottone cromato con deviatore automatico

Wall mounted bath mixer, chromed brass finishes. With automatic diverter

8510-010



Gruppo doccia a parete in ottone cromato

Wall mounted shower mixer, chromed brass finishes

 Ibis - bathroom

Ottimamente rifinito in ottone cromato offre una linea completa di rubinetteria per rispondere alle varie esigenze di utilizzo e di arredamento.

Finished in chrome-plated brass, it offers a complete line of fittings to meet the various needs of use and furniture.



...-010
Cromo • Chrome



...-018
Satinato • Satin



...-084
Nero Opaco • Mat Black



...-014
Bronzo • Bronze



...-013
Oro • Gold



8850-010-8897

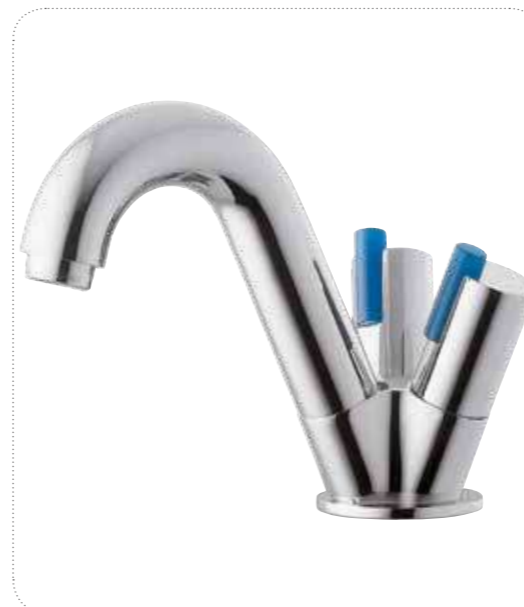

Batteria lavabo monoforo in ottone cromato con scarico automatico. Maniglie tipo G

Single hole basin mixer, chromed brass finishes. With automatic pop-up waste. G handles.

8820-010-8891



Batteria lavabo 3 fori in ottone cromato con scarico automatico. Maniglie tipo A bianco.

3-holes basin group, chromed brass finishes. With automatic pop-up waste. White A handles.

8856-010-8898



Gruppo lavabo incasso in ottone cromato con bocca da 165mm. Scarico click-clack. Maniglie tipo F.

Wall mounted basin mixer, chromed brass finishes. With 165 mm spout. Click clack waste. F handles.

8858-010-8898



Gruppo lavabo incasso in ottone cromato con bocca da 165mm. Scarico click-clack. Maniglie tipo F.

Wall mounted basin mixer, chromed brass finishes. With 165 mm spout. Click clack waste. F handles.

8845-010-8897

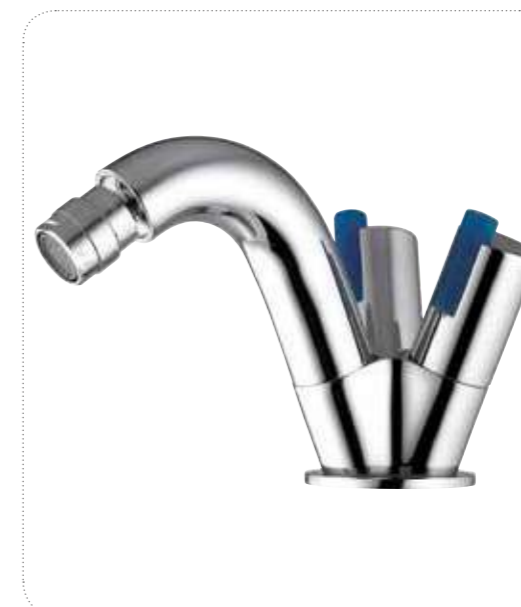

Batteria bidet monoforo in ottone cromato con scarico automatico. Maniglie tipo G

Single hole bidet mixer, chromed brass finishes. With automatic pop-up waste. G handles.

8825-010-8891

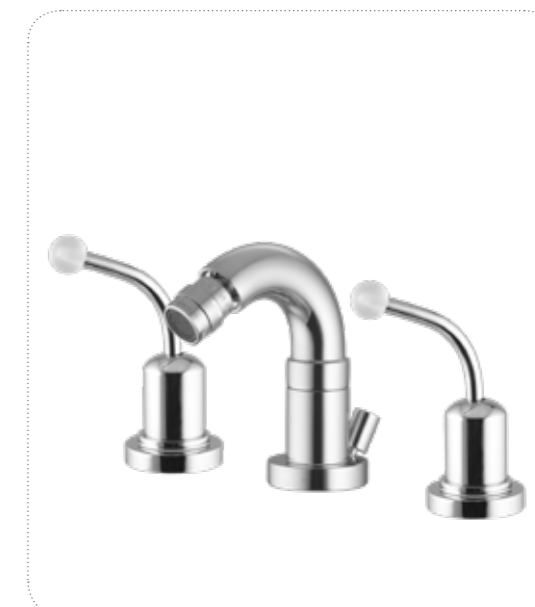

Batteria bidet 3 fori in ottone cromato con scarico automatico. Maniglie tipo A bianco.

3-holes bidet group, chromed brass finishes. With automatic pop-up waste. White A handles.



8801-010-8896



Gruppo vasca in ottone cromato con deviatore automatico. Maniglie tipo F.

Wall mounted bath mixer, chromed brass finishes. With automatic diverter. F handles.

8810-010-8897



Gruppo doccia a parete in ottone cromato. Maniglie tipo G.

Wall mounted shower mixer, chromed brass finishes. G handles.

8815-010-8898



Gruppo doccia incasso in ottone cromato con deviatore 2 vie. Maniglie tipo F.

Built-in shower mixer, chromed brass finishes with diverter 2 ways. F handles.

8816-010-8898



Gruppo doccia incasso in ottone cromato con deviatore 3 vie. Maniglie tipo F.

Built-in shower mixer, chromed brass finishes with diverter 3 ways. F handles.

M Dyno- bathroom

Serie dalla forma accattivante e di alta qualità, si caratterizza per i piccoli dettagli colorati che rendono giocoso un oggetto di uso quotidiano.

Appealing and high quality line. It is marked by small colored details which give a playful characteristic at a daily object.



8850-010-8897
Lavabo Dyno con maniglia tipo G
Basin mixer with G type handle



8850-010-8896
Lavabo Dyno con maniglia tipo F
Basin mixer with F type handle



8850-010-8891
Lavabo Dyno con maniglia tipo A bianco
Basin mixer with white A type handle



8850-010-8891
Lavabo Dyno con maniglia tipo A verde
Basin mixer with green A type handle

- 
...-010
Cromo • Chrome
- 
...-018
Satinato • Satin
- 
...-084
Nero Opaco • Mat Black
- 
...-014
Bronzo • Bronze
- 
...-013
Oro • Gold



 Energy

6250-010



Miscelatore monocomando lavabo in ottone cromato. Con scarico automatico.

Single lever basin mixer, chromed brass finishes. With automatic pop-up waste

6220-010



Batteria lavabo 3 fori in ottone cromato con bocca girevole, scarico automatico

3-holes basin group, chromed brass finishes. With automatic pop-up waste

6256-010

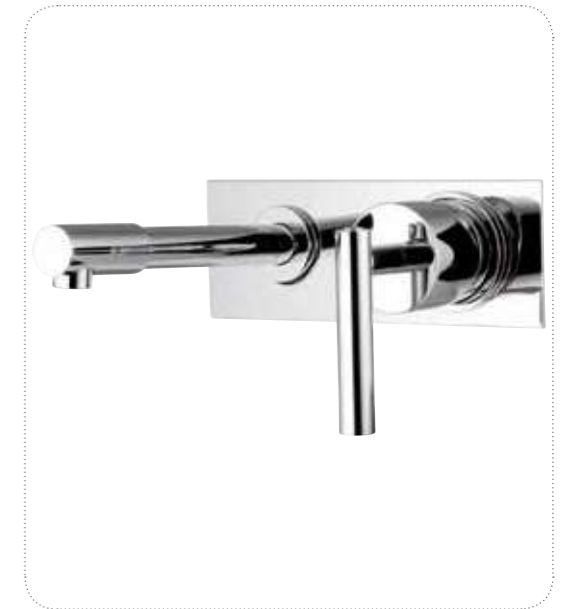

Miscelatore monocomando lavabo incasso con bocca da 165mm. Scarico click-clack.

Built-in single lever basin mixer, chromed brass finishes, with 165 mm spout. Click clack waste

6258-010

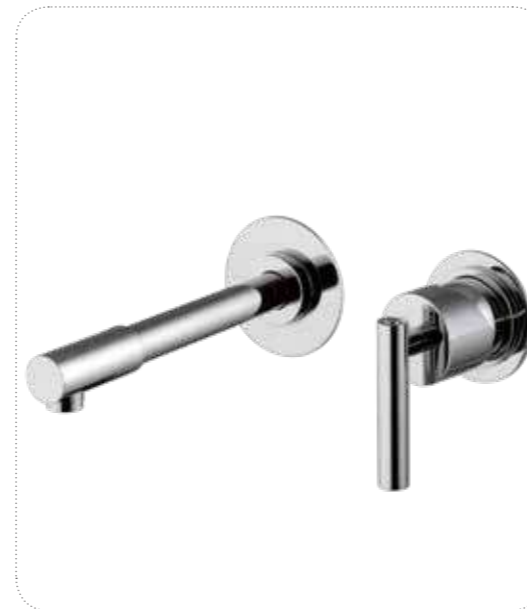

Miscelatore lavabo incasso in ottone cromato con bocca da 165mm. Scarico click-clack.

Wall mounted single lever basin mixer, chromed brass finishes. With 165 mm spout. Click clack waste

7058-010



Gruppo lavabo incasso in ottone cromato con bocca da 165mm. Scarico click-clack.

Wall mounted basin mixer, chromed brass finishes. With 165 mm spout. Click clack waste

Extensions



2211-010
100 mm

2212-010
150 mm

2213-010
200 mm



6260-010



Miscelatore monocomando bidet in ottone cromato. Con scarico automatico.

Single lever bidet mixer, chromed brass finishes. With automatic pop-up waste

6225-010

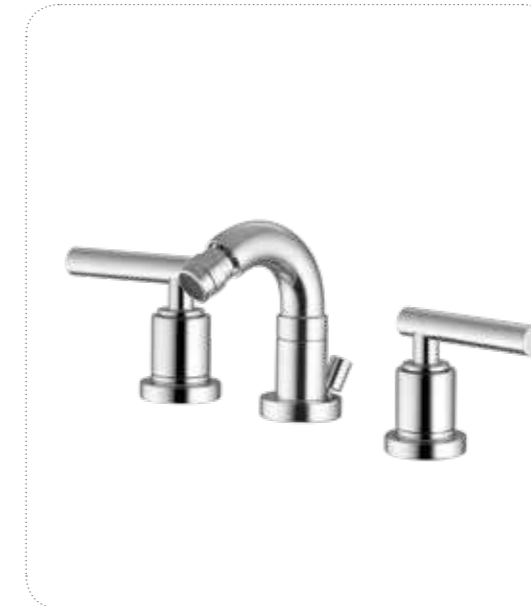

Batteria bidet 3 fori in ottone cromato con bocca girevole, scarico automatico

3-holes bidet group, chromed brass finishes. With automatic pop-up waste

7095-010



Rubinetti incasso 1/2" in ottone cromato

Built-in tap 1/2" chromed brass finishes

Bocca 1



Bocca a cascata a spigolo in acciaio inox con uscita acqua aperta

Built-in stainless steel waterfall jet bathtub filling mouth

Bocca 2



Bocca a cascata curva in acciaio inox.

Built-in stainless steel waterfall jet bathtub filling mouth

Bocca 3



Bocca a cascata in acciaio inox.

Built-in stainless steel waterfall jet bathtub filling mouth



6201-010



Miscelatore vasca in ottone cromato con deviatore automatico
Wall mounted single lever bath mixer, chromed brass finishes. With automatic diverter

6210-010



Miscelatore esterno doccia in ottone cromato.
Wall mounted single lever shower mixer, chromed brass finishes.

6242-010



Miscelatore incasso doccia in ottone cromato.
Built-in single lever shower mixer, chromed brass finishes.

6241-010



Miscelatore incasso doccia in ottone cromato con deviatore 2 vie.
Built-in single lever shower mixer, chromed brass finishes with 2 ways diverter

7053-010



Gruppo doccia incasso in ottone cromato con deviatore 3 vie.
Built-in shower mixer, chromed brass finishes with diverter 3 ways.

6202-010



Miscelatore vasca a pavimento in ottone cromato, con kit doccia minimal
Freestanding single lever bath column, chromed brass finishes with minimal shower kit



M Energy- bathroom

Elegante e dalle dimensioni imponenti, è l'ideale in una sala bagno moderna dallo stile pulito.

Elegant and imposing ideal in a modern bathroom thanks to the clean and elegant style.



...-010
Cromo • Chrome



...-018
Satinato • Satin



...-084
Nero Opaco • Mat Black



...-014
Bronzo • Bronze



...-013
Oro • Gold



8450-010



Miscelatore monocomando lavabo in ottone cromato. Con scarico automatico.

Single lever basin mixer, chromed brass finishes. With automatic pop-up waste

8460-010



Miscelatore monocomando bidet in ottone cromato. Con scarico automatico.

Single lever bidet mixer, chromed brass finishes. With automatic pop-up waste

8401-010



Miscelatore vasca in ottone cromato con deviatore automatico

Wall mounted single lever bath mixer, chromed brass finishes. With automatic diverter

8410-010



Miscelatore esterno doccia in ottone cromato.

Wall mounted single lever shower mixer, chromed brass finishes.

8440-010



Miscelatore incasso doccia in ottone cromato.

Built-in single lever shower mixer, chromed brass finishes.

8441-010



Miscelatore incasso doccia in ottone cromato con deviatore 2 vie.

Built-in single lever shower mixer, chromed brass finishes with 2 ways diverter



Galileo - bathroom

M Galileo - bathroom

Progetto ardito che unisce in un unico corpo le forme quadrate e quelle tonde con estrema eleganza e funzionalità.

A bold design that combines in one body the round and square shapes with extreme elegance and functionality.



...-010
Cromo • Chrome



...-018
Satinato • Satin



...-084
Nero Opaco • Mat Black



...-014
Bronzo • Bronze



...-013
Oro • Gold





14050-010



Miscelatore monocomando lavabo in ottone cromato. Con scarico click clack.

Single lever basin mixer, chromed brass finishes. With click clack waste

14051-010



Miscelatore monocomando lavabo alto in ottone cromato. Con scarico click clack.

High single lever basin mixer, chromed brass finishes. With click clack waste

14058-010



Miscelatore monocomando lavabo incasso con bocca da 170mm. Scarico click clack.

Built-in single lever basin mixer, chromed brass finishes, with 170 mm spout. Click clack waste

14057-010

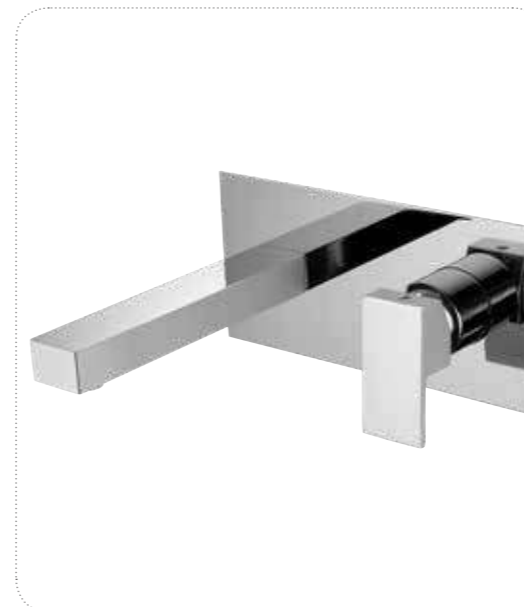

Miscelatore monocomando lavabo incasso con bocca da 170mm. Scarico click clack.

Built-in single lever basin mixer, chromed brass finishes, with 170 mm spout. Click clack waste

14060-010



Miscelatore monocomando bidet in ottone cromato. Con scarico click clack.

Single lever bidet mixer, chromed brass finishes. With click clack waste

14001-010



Miscelatore vasca in ottone cromato con deviatore automatico

Wall mounted single lever bath mixer, chromed brass finishes. With automatic diverter

14000-010



Miscelatore vasca in ottone cromato con deviatore automatico. Con pillars per installazione a bordo vasca.

Deck mounted single lever bath mixer with pillars, chromed brass finishes. With automatic diverter.

14010-010



Miscelatore esterno doccia in ottone cromato.

Wall mounted single lever shower mixer, chromed brass finishes.

14040-010



Miscelatore incasso doccia in ottone cromato.

Built-in single lever shower mixer, chromed brass finishes.

14041-010



Miscelatore incasso doccia in ottone cromato con deviatore 2 vie.

Built-in single lever shower mixer, chromed brass finishes with 2 ways diverter

14002-010



Miscelatore vasca a pavimento in ottone cromato, con kit doccia minimal

Freestanding single lever bath column, chromed brass finishes with minimal shower kit





Quadra - bathroom

M Quadra- bathroom

Rigorous nella forma quadrata, asseconda le ultime tendenze dell'arredo bagno.

Rigorous in square shape, following the latest trends in bathroom furnishings.





 Magica

13050-010



Miscelatore monocomando lavabo in ottone cromato. Con scarico automatico.

Single lever basin mixer, chromed brass finishes. With automatic pop-up waste

13051-010



Miscelatore monocomando lavabo alto in ottone cromato. Con scarico click clack.

High single lever basin mixer, chromed brass finishes. With click clack waste

13057-010

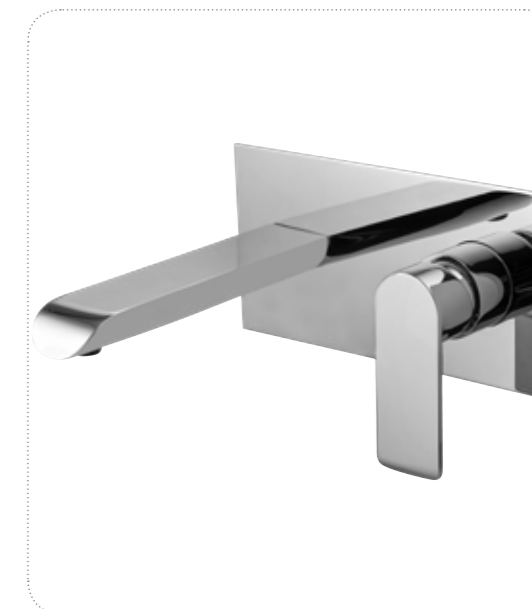

Miscelatore monocomando lavabo incasso con bocca da 165mm. Scarico click clack.

Built-in single lever basin mixer, chromed brass finishes, with 165 mm spout. Click clack waste

13060-010



Miscelatore monocomando bidet in ottone cromato. Con scarico automatico.

Single lever bidet mixer, chromed brass finishes. With automatic pop-up waste



M Magica- collection

13001-010



Miscelatore vasca in ottone cromato con deviatore automatico
Wall mounted single lever bath mixer, chromed brass finishes. With automatic diverter

13010-010



Miscelatore esterno doccia in ottone cromato.
Wall mounted single lever shower mixer, chromed brass finishes.

13040-010



Miscelatore incasso doccia in ottone cromato.
Built-in single lever shower mixer, chromed brass finishes.

13041-010



Miscelatore incasso doccia in ottone cromato con deviatore 2 vie.
Built-in single lever shower mixer, chromed brass finishes with 2 ways diverter





Linee decise che abbinano modernità e praticità. Gamma adatta a qualsiasi ambiente.

Decided lines that combine modernity and practicality. Suitable range for any bathroom furniture.





 Vision

22050-010



Miscelatore monocomando lavabo in ottone cromato. Con scarico click clack.

Single lever basin mixer, chromed brass finishes. With click clack waste

22051-010



Miscelatore monocomando lavabo alto in ottone cromato. Con scarico click clack.

High single lever basin mixer, chromed brass finishes. With click clack waste

22056-010



Miscelatore monocomando lavabo incasso con bocca da 146 mm. Scarico click clack. Bocca posizionabile a destra o sinistra.

Built-in single lever basin mixer, chromed brass finishes, with 146 mm spout. Click clack waste. Mouth can be positioned on the right or left side.

22057-010



Miscelatore monocomando lavabo incasso con bocca da 146 mm. Scarico click clack.

Built-in single lever basin mixer, chromed brass finishes, with 146 mm spout. Click clack waste

22058-010



Miscelatore monocomando lavabo incasso con bocca da 146 mm. Scarico click clack. Bocca posizionabile a destra o sinistra.

Built-in single lever basin mixer, chromed brass finishes, with 146 mm spout. Click clack waste. Mouth can be positioned on the right or left side.

22060-010



Miscelatore monocomando bidet in ottone cromato. Con scarico click clack.

Single lever bidet mixer, chromed brass finishes. With click clack waste

22001-010



Miscelatore vasca in ottone cromato con deviatore automatico

Wall mounted single lever bath mixer, chromed brass finishes. With automatic diverter

22010-010



Miscelatore esterno doccia in ottone cromato.

Wall mounted single lever shower mixer, chromed brass finishes.

22040-010



Miscelatore incasso doccia in ottone cromato.

Built-in single lever shower mixer, chromed brass finishes.

22041-010



Miscelatore incasso doccia in ottone cromato con deviatore 2 vie.

Built-in single lever shower mixer, chromed brass finishes with 2 ways diverter

22005-010



Miscelatore monocomando bordo vasca con deviatore e doccia.

Deck mounted single lever bath mixer with diverter and shower kit.

22006-010



Miscelatore monocomando bordo vasca con deviatore push-botton, bocca di erogazione e doccia.

Deck mounted single lever bath mixer with push-botton diverter, mouth and shower kit.





 Kepler

19050-010



Miscelatore monocomando lavabo in ottone cromato. Con scarico click clack.

Single lever basin mixer, chromed brass finishes. With click clack waste

19051-010



Miscelatore monocomando lavabo medio in ottone cromato. Con scarico click clack.

Medium single lever basin mixer, chromed brass finishes. With click clack waste

19052-010



Miscelatore monocomando lavabo alto in ottone cromato. Con scarico click clack.

High single lever basin mixer, chromed brass finishes. With click clack waste

19056-010



Miscelatore monocomando lavabo incasso con bocca da 146 mm. Scarico click clack. Bocca posizionabile a destra o sinistra.

Built-in single lever basin mixer, chromed brass finishes, with 146 mm spout. Click clack waste. Mouth can be positioned on the right or left side.

19057-010



Miscelatore monocomando lavabo incasso con bocca da 146 mm. Scarico click clack.

Built-in single lever basin mixer, chromed brass finishes, with 146 mm spout. Click clack waste

19058-010



Miscelatore monocomando lavabo incasso con bocca da 146 mm. Scarico click clack. Bocca posizionabile a destra o sinistra.

Built-in single lever basin mixer, chromed brass finishes, with 146 mm spout. Click clack waste. Mouth can be positioned on the right or left side.

19060-010



Miscelatore monocomando bidet in ottone cromato. Con scarico click clack.

Single lever bidet mixer, chromed brass finishes. With click clack waste

19001-010



Miscelatore vasca in ottone cromato con deviatore automatico

Wall mounted single lever bath mixer, chromed brass finishes. With automatic diverter

19010-010



Miscelatore esterno doccia in ottone cromato.

Wall mounted single lever shower mixer, chromed brass finishes.

19006-010



Miscelatore monocomando bordo vasca con deviatore push-botton, bocca di erogazione e doccia.

Deck mounted single lever bath mixer with push-botton diverter, mouth and shower kit.

19007-010



Miscelatore monocomando bordo vasca con deviatore, bocca di erogazione e doccia.

Deck mounted single lever bath mixer with diverter, mouth and shower kit.

19040-010



Miscelatore incasso doccia in ottone cromato.

Built-in single lever shower mixer, chromed brass finishes.

19041-010



Miscelatore incasso doccia in ottone cromato con deviatore 2 vie.

Built-in single lever shower mixer, chromed brass finishes with 2 ways diverter

19005-010



Miscelatore monocomando bordo vasca con deviatore e doccia.

Deck mounted single lever bath mixer with diverter and shower kit.



17050-010



Miscelatore monocomando lavabo in ottone cromato. Con scarico automatico.

Single lever basin mixer, chromed brass finishes. With automatic pop-up waste

17060-010



Miscelatore monocomando bidet in ottone cromato. Con scarico automatico.

Single lever bidet mixer, chromed brass finishes. With automatic pop-up waste

17001-010



Miscelatore vasca in ottone cromato con deviatore automatico

Wall mounted single lever bath mixer, chromed brass finishes. With automatic diverter

17010-010



Miscelatore esterno doccia in ottone cromato.

Wall mounted single lever shower mixer, chromed brass finishes.

17040-010



Miscelatore incasso doccia in ottone cromato.

Built-in single lever shower mixer, chromed brass finishes.



M Moon- bathroom

Le curve sinuose di questo rubinetto accompagnano il getto d'acqua creando un'onda piacevolmente morbida.

The smooth curves of this tap accompanies the flow of water, thus creating a pleasantly soft wave.



...-010
Cromo • Chrome



...-018
Satinato • Satin



...-084
Nero Opaco • Mat Black



...-014
Bronzo • Bronze



...-013
Oro • Gold



4550-010



Miscelatore monocomando lavabo in ottone cromato. Con scarico automatico.
Single lever basin mixer, chromed brass finishes. With automatic pop-up waste

4553-010



Miscelatore monocomando lavabo in ottone cromato con leva laterale. Con scarico automatico.
Single lever basin mixer, chromed brass finishes. With automatic pop-up waste

4551-010



Miscelatore monocomando lavabo alto in ottone cromato. Con scarico click clack.
High single lever basin mixer, chromed brass finishes. With click clack waste

4557-010



Miscelatore monocomando lavabo incasso con bocca da 165mm. Scarico click clack.
Built-in single lever basin mixer, chromed brass finishes, with 165 mm spout. Click clack waste

4560-010



Miscelatore monocomando bidet in ottone cromato. Con scarico automatico.
Single lever bidet mixer, chromed brass finishes. With automatic pop-up waste

4502-010



Miscelatore termostatico vasca a pavimento in ottone cromato, con kit doccia minimal
Freestanding thermostatic single lever bath column, chromed brass finishes with minimal shower kit



4501-010



Miscelatore vasca in ottone cromato con deviatore automatico

Wall mounted single lever bath mixer, chromed brass finishes. With automatic diverter

4505-010

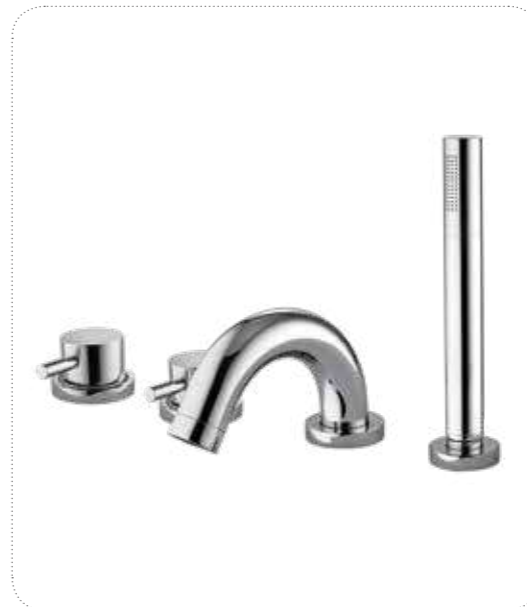

Miscelatore monocomando bordo vasca con deviatore, bocca di erogazione e doccia.

Deck mounted single lever bath mixer with diverter, mouth and shower kit.

4510-010



Miscelatore esterno doccia in ottone cromato.

Wall mounted single lever shower mixer, chromed brass finishes.

4540-010



Miscelatore incasso doccia in ottone cromato.

Built-in single lever shower mixer, chromed brass finishes.

4541-010



Miscelatore incasso doccia in ottone cromato con deviatore 2 vie.

Built-in single lever shower mixer, chromed brass finishes with 2 ways diverter

4542-010



Deviatore da 1 a 5 vie

Built-in 1 to 5 ways diverter



M Fashion- bathroom

Allo stesso tempo semplice ma con personalità. Questa serie si abbina a qualsiasi tipo di bagno moderno.

At the same time simple but with personality. This serie matched to any type of modern bathrooms.



...-010
Cromo • Chrome



...-018
Satinato • Satin



...-084
Nero Opaco • Mat Black



...-014
Bronzo • Bronze



...-013
Oro • Gold



24050-010



Miscelatore monocomando lavabo in ottone cromato. Con scarico automatico.
Single lever basin mixer, chromed brass finishes. With automatic pop-up waste

24001-010



Miscelatore vasca in ottone cromato con deviatore automatico
Wall mounted single lever bath mixer, chromed brass finishes. With automatic diverter

24010-010



Miscelatore esterno doccia in ottone cromato.
Wall mounted single lever shower mixer, chromed brass finishes.

24040-010



Miscelatore incasso doccia in ottone cromato.
Built-in single lever shower mixer, chromed brass finishes.

24041-010



Miscelatore incasso doccia in ottone cromato con deviatore 2 vie.
Built-in single lever shower mixer, chromed brass finishes with 2 ways diverter



2350-010



Miscelatore monocomando lavabo in ottone cromato. Con scarico automatico.

Single lever basin mixer, chromed brass finishes. With automatic pop-up waste

2360-010



Miscelatore monocomando bidet in ottone cromato. Con scarico automatico.

Single lever bidet mixer, chromed brass finishes. With automatic pop-up waste

2301-010



Miscelatore vasca in ottone cromato con deviatore automatico

Wall mounted single lever bath mixer, chromed brass finishes. With automatic diverter

2310-010



Miscelatore esterno doccia in ottone cromato.

Wall mounted single lever shower mixer, chromed brass finishes.

2340-010



Miscelatore incasso doccia in ottone cromato.

Built-in single lever shower mixer, chromed brass finishes.

2341-010



Miscelatore incasso doccia in ottone cromato con deviatore 2 vie.

Built-in single lever shower mixer, chromed brass finishes with 2 ways diverter

M Oka- bathroom

Questo prodotto dalla forma originale e spiritosa, gioca con le forme curve che conferiscono un aspetto morbido e gentile a tutta la serie.

Original and spirited faucet, it plays with curved shapes that give a soft and gentle look to the whole range.



...-010
Cromo • Chrome



...-018
Satinato • Satin



...-084
Nero Opaco • Mat Black



...-014
Bronzo • Bronze



...-013
Oro • Gold



23050-010



Miscelatore monocomando lavabo in ottone cromato. Con scarico automatico.
Single lever basin mixer, chromed brass finishes. With automatic pop-up waste

23001-010



Miscelatore vasca in ottone cromato con deviatore automatico
Wall mounted single lever bath mixer, chromed brass finishes. With automatic diverter

23010-010



Miscelatore esterno doccia in ottone cromato.
Wall mounted single lever shower mixer, chromed brass finishes.

23040-010



Miscelatore incasso doccia in ottone cromato.
Built-in single lever shower mixer, chromed brass finishes.

23041-010



Miscelatore incasso doccia in ottone cromato con deviatore 2 vie.
Built-in single lever shower mixer, chromed brass finishes with 2 ways diverter



9850-010



Miscelatore monocomando lavabo in ottone cromato. Con scarico automatico.

Single lever basin mixer, chromed brass finishes. With automatic pop-up waste

9851-010



Miscelatore monocomando lavabo alto in ottone cromato. Con scarico automatico.

High single lever basin mixer, chromed brass finishes. With automatic pop-up waste

9860-010



Miscelatore monocomando bidet in ottone cromato. Con scarico automatico.

Single lever bidet mixer, chromed brass finishes. With automatic pop-up waste

9801-010



Miscelatore vasca in ottone cromato con deviatore automatico

Wall mounted single lever bath mixer, chromed brass finishes. With automatic diverter

9810-010



Miscelatore esterno doccia in ottone cromato.

Wall mounted single lever shower mixer, chromed brass finishes.

9840-010



Miscelatore incasso doccia in ottone cromato.

Built-in single lever shower mixer, chromed brass finishes.

M Alta - colours

Sfruttando un innovativo sistema di Wrapping è possibile applicare ai nostri prodotti più di 250 finiture, a catalogo un esempio di: legno, marmo e carbonio.

Using an innovative Wrapping system, we can apply to our products more than 250 different finishes: catalogue showing an example of wood, marble and carbon.



9850-010
Cromo
Chrome



9850-700
Carbonio
Carbon



9850-600
Legno
Wood



9850-500
Marmo
Marble



900210011-001
Kit Luce



3850-010



Miscelatore monocomando lavabo in ottone cromato. Con scarico automatico.

Single lever basin mixer, chromed brass finishes. With automatic pop-up waste

3860-010



Miscelatore monocomando bidet in ottone cromato. Con scarico automatico.

Single lever bidet mixer, chromed brass finishes. With automatic pop-up waste

3801-010



Miscelatore vasca in ottone cromato con deviatore automatico

Wall mounted single lever bath mixer, chromed brass finishes. With automatic diverter

3810-010



Miscelatore esterno doccia in ottone cromato.

Wall mounted single lever shower mixer, chromed brass finishes.

3840-010



Miscelatore incasso doccia in ottone cromato.

Built-in single lever shower mixer, chromed brass finishes.

3841-010



Miscelatore incasso doccia in ottone cromato con deviatore 2 vie.

Built-in single lever shower mixer, chromed brass finishes with 2 ways diverter



1050-010



Miscelatore monocomando lavabo in ottone cromato. Con scarico automatico.

Single lever basin mixer, chromed brass finishes. With automatic pop-up waste

1060-010



Miscelatore monocomando bidet in ottone cromato. Con scarico automatico.

Single lever bidet mixer, chromed brass finishes. With automatic pop-up waste

1001-010



Miscelatore vasca in ottone cromato con deviatore automatico

Wall mounted single lever bath mixer, chromed brass finishes. With automatic diverter

1010-010



Miscelatore esterno doccia in ottone cromato.

Wall mounted single lever shower mixer, chromed brass finishes.

1040-010



Miscelatore incasso doccia in ottone cromato.

Built-in single lever shower mixer, chromed brass finishes.

1041-010



Miscelatore incasso doccia in ottone cromato con deviatore 2 vie.

Built-in single lever shower mixer, chromed brass finishes with 2 ways diverter



 Athena

250-010



Miscelatore monocomando lavabo in ottone cromato. Con scarico automatico.

Single lever basin mixer, chromed brass finishes. With automatic pop-up waste

257-010



Miscelatore monocomando lavabo alto in ottone cromato. Con scarico click clack.

High single lever basin mixer, chromed brass finishes. With click clack waste

256-010



Miscelatore monocomando lavabo in ottone cromato. Con scarico automatico e doccetta estraibile

Single lever basin mixer, chromed brass finishes. With automatic pop-up waste and pull-out spray

260-010



Miscelatore monocomando bidet in ottone cromato. Con scarico automatico.

Single lever bidet mixer, chromed brass finishes. With automatic pop-up waste

250-010/LC

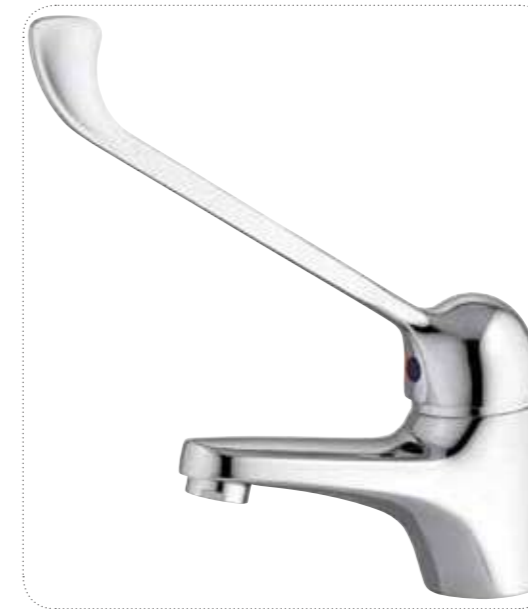

Miscelatore monocomando lavabo in ottone cromato. Con leva clinica

Single lever basin mixer, chromed brass finishes. With clinic lever.



201-010



Miscelatore vasca in ottone cromato con deviatore automatico

Wall mounted single lever bath mixer, chromed brass finishes. With automatic diverter

210-010



Miscelatore esterno doccia in ottone cromato.

Wall mounted single lever shower mixer, chromed brass finishes.

240-010



Miscelatore incasso doccia in ottone cromato.

Built-in single lever shower mixer, chromed brass finishes.

M Athena- bathroom

La semplicità si fonde con la praticità e la sicurezza per una gamma che dura nel tempo, rimanendo sempre attuale.

Simplicity blends in with practicality and safety for a range that lasts long, always remaining up to date



- 
 ...-010
 Cromo • Chrome
- 
 ...-018
 Satinato • Satin
- 
 ...-084
 Nero Opaco • Mat Black
- 
 ...-014
 Bronzo • Bronze
- 
 ...-013
 Oro • Gold



1830-010



Batteria lavabo monoforo in ottone cromato con scarico automatico. Maniglie in cristallo.

Single hole basin mixer, chromed brass finishes. With automatic pop-up waste. Crystal handles.

1820-010



Batteria lavabo 3 fori in ottone cromato con scarico automatico. Maniglie in cristallo.

3-holes basin group, chromed brass finishes. With automatic pop-up waste. Crystal handles.

1845-010



Batteria bidet monoforo in ottone cromato con scarico automatico. Maniglie in cristallo.

Single hole bidet mixer, chromed brass finishes. With automatic pop-up waste. Crystal handles.

1801-010



Gruppo vasca in ottone cromato con deviatore automatico. Maniglie in cristallo.

Wall mounted bath mixer, chromed brass finishes. With automatic diverter. Crystal handles.

1805-010



Gruppo vasca in ottone cromato con deviatore e kit doccia monogetto in ottone cromato. Maniglie in cristallo.

Wall mounted bath mixer, chromed brass finishes. With diverter and brass 1 jet shower kit. Crystal handles.

1804-010



Gruppo bordo vasca in ottone cromato con deviatore e kit doccia 3 getti. Maniglie in cristallo

Deck mounted bath mixer, chromed brass finishes. With diverter and 3 jets shower kit. Crystal handles.

1852-010



Gruppo vasca incasso in ottone cromato. Con bocca di erogazione, deviatore e kit doccia con presa acqua. Maniglie in cristallo.

Built-in bath mixer, chromed brass finishes. With mouth, diverter and shower kit with water outlet. Crystal handles.

1810-010



Gruppo doccia a parete in ottone cromato. Maniglie in cristallo.

Wall mounted shower mixer, chromed brass finishes. Crystal handles.

1811-010



Gruppo doccia a parete in ottone cromato. Maniglie in cristallo. Attacco alto per colonna doccia

Wall mounted shower mixer, chromed brass finishes. Crystal handles. High outlet for shower column.



Maniglia Cristallo
Crystal Handle



Maniglia Cheope
Cheope Handle



Cheope - bathroom

M Cheope- bathroom

Forme classiche e maniglie di cristallo che risplendono con infiniti riflessi.
Diventa prezioso nell'abbinamento con la finitura Oro.

*Classic shapes and crystal handles that shines with infinite reflections.
It become precious when combined with Gold finishes.*



- 
 ...-010
 Cromo • Chrome
- 
 ...-018
 Satinato • Satin
- 
 ...-084
 Nero Opaco • Mat Black
- 
 ...-014
 Bronzo • Bronze
- 
 ...-013
 Oro • Gold



7550-010



Batteria lavabo monoforo in ottone cromato con scarico automatico.

Single hole basin group, chromed brass finishes. With automatic pop-up waste

7520-010



Batteria lavabo 3 fori in ottone cromato con bocca girevole, scarico automatico

3-holes basin group, chromed brass finishes. With automatic pop-up waste

7560-010



Batteria bidet monoforo in ottone cromato con scarico automatico.

Single hole bidet group, chromed brass finishes. With automatic pop-up waste

7525-010



Batteria bidet 3 fori in ottone cromato con bocca girevole, scarico automatico

3-holes bidet group, chromed brass finishes. With automatic pop-up waste

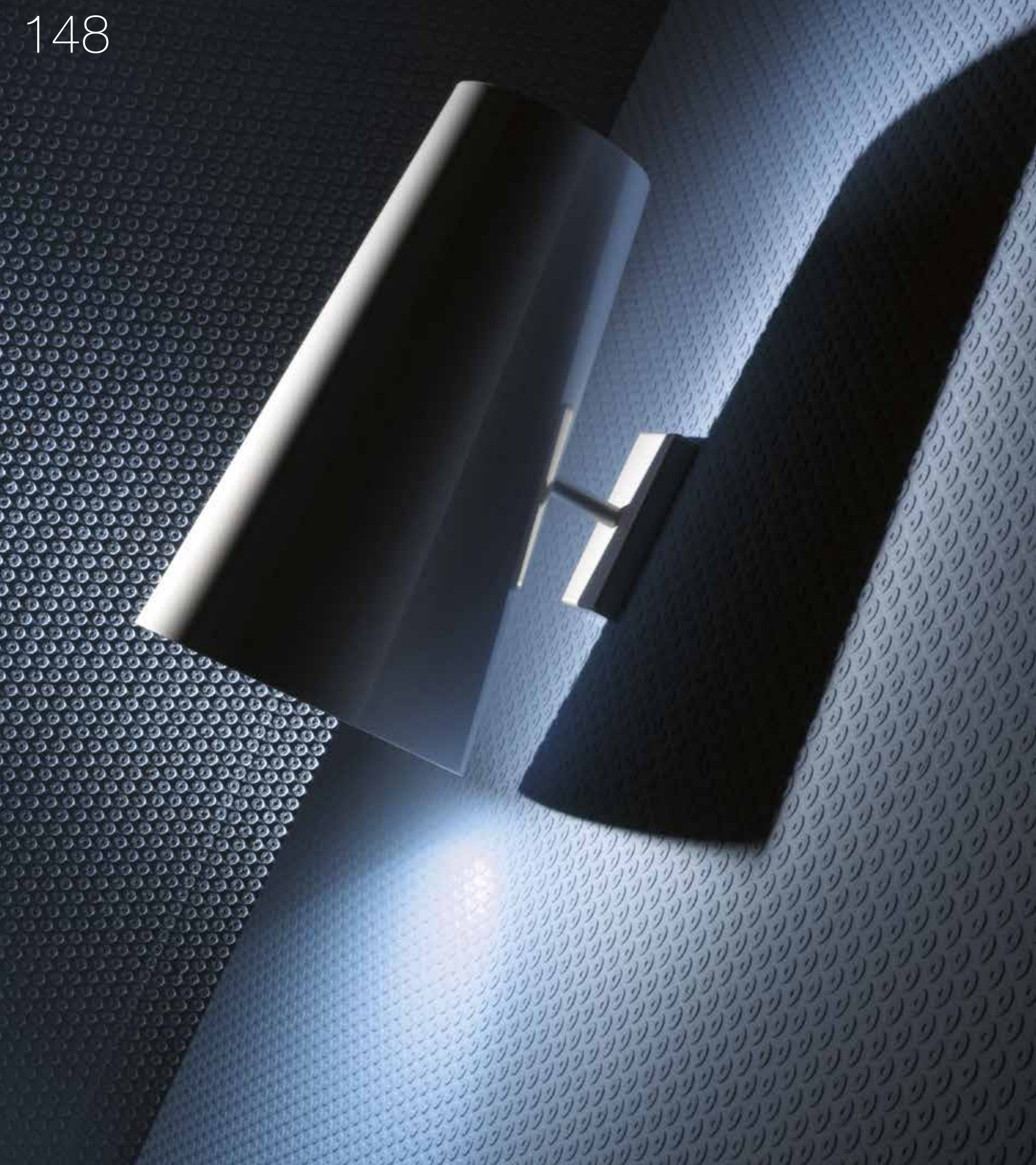

7501-010



Gruppo vasca in ottone cromato con deviatore automatico
Wall mounted bath mixer, chromed brass finishes. With automatic diverter

7510-010



Gruppo doccia a parete in ottone cromato
Wall mounted shower mixer, chromed brass finishes

7558-010



Gruppo vasca incasso in ottone cromato. Con bocca di erogazione.
Built-in bath mixer, chromed brass finishes with mouth.

7515-010

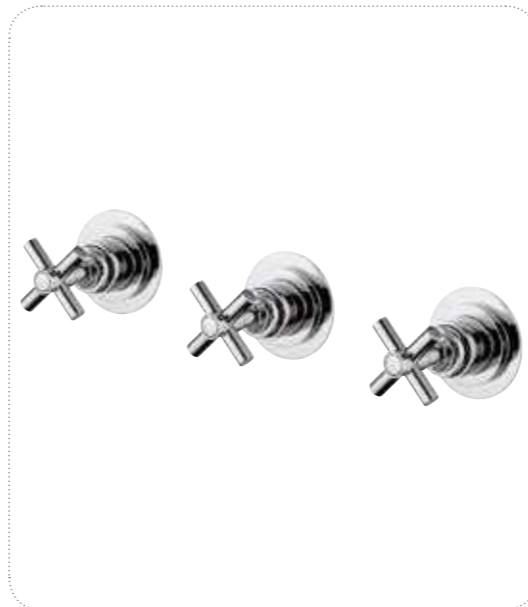

Gruppo doccia incasso in ottone cromato con deviatore 2 vie
Built-in shower mixer, chromed brass finishes with diverter 2 ways.

7516-010

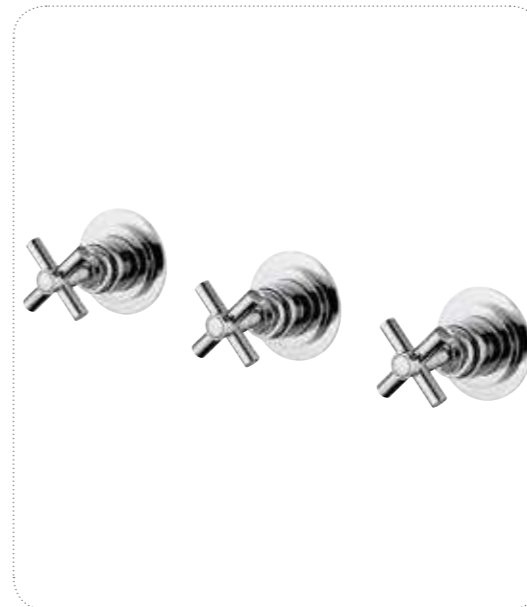

Gruppo doccia incasso in ottone cromato con deviatore 3 vie
Built-in shower mixer, chromed brass finishes with diverter 3 ways.



M Extra- bathroom

Interpretazione moderna del classico rubinetto con vitoni ceramici. Forme pulite e minimali che si adattano a tutti gli ambienti, fanno di questo rubinetto il nuovo classico.

Modern interpretation of the classic tap with ceramic disc. Clean and minimal shaped that fit into all bathroom, make this tap the new classic.



...-010 Cromo • Chrome ...-018 Satinato • Satin ...-084 Nero Opaco • Mat Black ...-014 Bronzo • Bronze ...-013 Oro • Gold



1635-010



Batteria lavabo monoforo in ottone cromato con scarico automatico.

Single hole basin group, chromed brass finishes. With automatic pop-up waste

1625-010



Batteria lavabo 3 fori in ottone cromato con bocca girevole, scarico automatico

3-holes basin group, chromed brass finishes. With automatic pop-up waste

1645-010



Batteria bidet monoforo in ottone cromato con scarico automatico.

Single hole bidet group, chromed brass finishes. With automatic pop-up waste

1641-010



Batteria bidet 3 fori in ottone cromato con bocca girevole, scarico automatico

3-holes bidet group, chromed brass finishes. With automatic pop-up waste

1655-010



Rubinetto lavabo cigno 1/2" in ottone cromato

Basin taps 1/2" chromed brass finishes



1600-010



Gruppo vasca in ottone cromato con deviatore e kit doccia monogetto in ottone cromato. Maniglie in cristallo.

Wall mounted bath mixer, chromed brass finishes. With diverter and brass 1 jet shower kit. Crystal handles.

1616-010



Gruppo vasca in ottone cromato con deviatore e kit doccia monogetto in ottone cromato. Maniglie in cristallo.

Wall mounted bath mixer, chromed brass finishes. With diverter and brass 1 jet shower kit. Crystal handles.

1650-010



Gruppo doccia a parete in ottone cromato.

Wall mounted shower mixer, chromed brass finishes.

1652-010



Gruppo doccia incasso in ottone cromato con deviatore 2 vie

Built-in shower mixer, chromed brass finishes with diverter 2 ways.

1653-010



Gruppo doccia incasso in ottone cromato con deviatore 3 vie

Built-in shower mixer, chromed brass finishes with diverter 3 ways.

M Camelot- bathroom

Le forme elaborate di questo rubinetto rievocano ambientazioni antiche. The elaborate shapes of this tap remember ancient atmospheres.



...-010 Cromo • Chrome ...-018 Satinato • Satin ...-084 Nero Opaco • Mat Black ...-014 Bronzo • Bronze ...-013 Oro • Gold



615-010



Batteria lavabo monoforo in ottone cromato con scarico automatico.

Single hole basin group, chromed brass finishes. With automatic pop-up waste

620-010



Batteria lavabo monoforo in ottone cromato con scarico automatico.

Single hole basin group, chromed brass finishes. With automatic pop-up waste

610-010

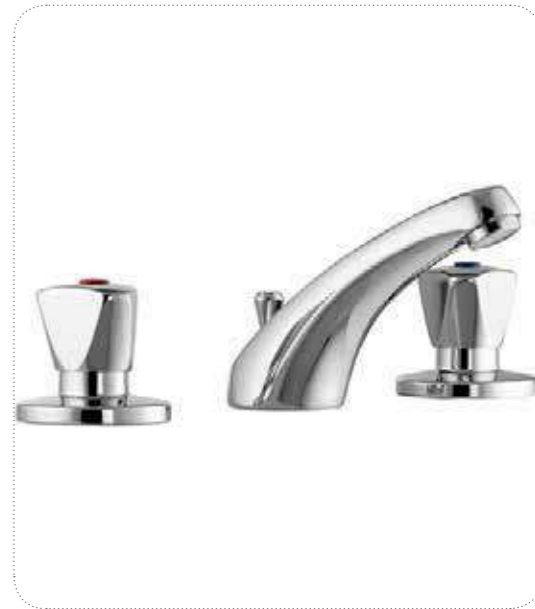

Batteria lavabo 3 fori in ottone cromato con bocca girevole, scarico automatico

3-holes basin group, chromed brass finishes. With automatic pop-up waste

640-010



Batteria bidet monoforo in ottone cromato con scarico automatico.

Single hole bidet group, chromed brass finishes. With automatic pop-up waste

650-010



Rubinetto lavabo cigno 1/2" in ottone cromato

Basin taps 1/2" chromed brass finishes

695-010



Rubinetto incasso 1/2" in ottone cromato

Built-in tap 1/2" chromed brass finishes



600-010

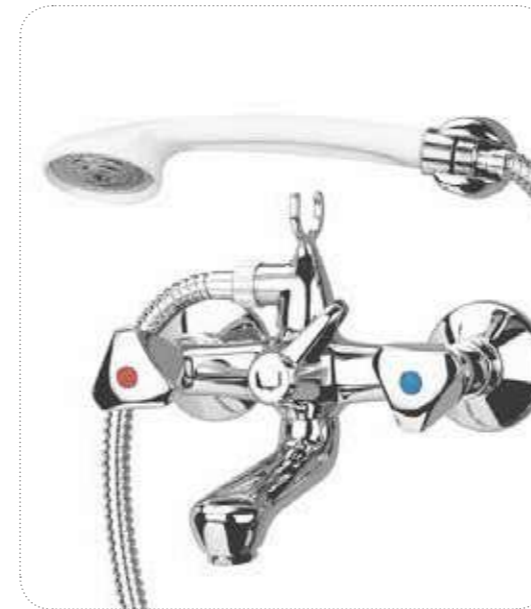

Gruppo vasca in ottone cromato con deviatore e kit doccia monogetto.

Wall mounted bath mixer, chromed brass finishes. With diverter and 1 jet shower kit.

645-010

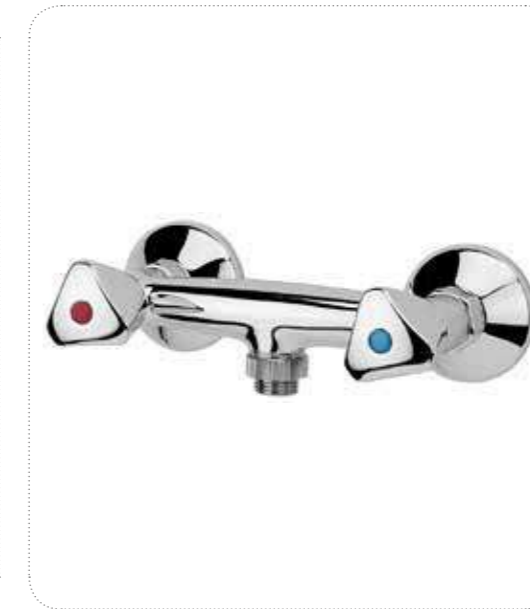

Gruppo doccia a parete in ottone cromato.

Wall mounted shower mixer, chromed brass finishes.

652-010



Gruppo vasca incasso in ottone cromato. Con bocca di erogazione, deviatore e kit doccia con presa acqua.

Built-in bath mixer, chromed brass finishes. With mouth, diverter and shower kit with water outlet.



18084-010



Miscelatore monocomando lavello in ottone cromato con bocca girevole.

Single lever sink mixer, chromed brass finishes with swivel spout

18087-010



Miscelatore monocomando lavello in ottone cromato con bocca girevole.

Single lever sink mixer, chromed brass finishes with swivel spout

2380-010



Miscelatore monocomando lavello in ottone cromato con bocca girevole.

Single lever sink mixer, chromed brass finishes with swivel spout

6280-010



Miscelatore monocomando lavello in ottone cromato con bocca girevole.

Single lever sink mixer, chromed brass finishes with swivel spout

4580-010



Miscelatore monocomando lavello in ottone cromato con bocca girevole.

Single lever sink mixer, chromed brass finishes with swivel spout

14080-010



Miscelatore monocomando lavello in ottone cromato con bocca girevole.

Single lever sink mixer, chromed brass finishes with swivel spout



8080-010



Gruppo lavello monoforo in ottone cromato con bocca girevole e dosa-sapone in vetro temperato blu.

Single hole sink mixer, chromed brass finishes. With swivel spout and blue tempered glass soap dispenser

7080-010



Gruppo lavello monoforo in ottone cromato con bocca girevole.

Single hole sink mixer, chromed brass finishes. With swivel spou.

7580-010



Gruppo lavello monoforo in ottone cromato con bocca girevole.

Single hole sink mixer, chromed brass finishes. With swivel spou.

6290-010



Miscelatore monocomando lavello in ottone cromato con bocca girevole e doccetta estraibile.

Single lever sink mixer, chromed brass finishes. With swivel spout and pull-out spray

6292-010



Miscelatore monocomando lavello in ottone cromato con bocca girevole e doccetta estraibile.

Single lever sink mixer, chromed brass finishes. With swivel spout and pull-out spray

18085-010



Miscelatore monocomando lavello in ottone cromato con bocca girevole e doccetta estraibile.

Single lever sink mixer, chromed brass finishes. With swivel spout and pull-out spray

1665-010



Gruppo lavello monoforo in ottone cromato con bocca girevole.

Single hole sink mixer, chromed brass finishes. With swivel spou.

1638-010



Gruppo lavello monoforo in ottone cromato con bocca girevole.

Single hole sink mixer, chromed brass finishes. With swivel spou.

18080-010



Miscelatore monocomando lavello in ottone cromato con bocca girevole e molla.

Single lever sink mixer, chromed brass finishes with swivel spout and spring pull down.

3791-010



Miscelatore monocomando lavello in ottone cromato con bocca girevole e doccetta estraibile.

Single lever sink mixer, chromed brass finishes. With swivel spout and pull-out spray

291-010



Miscelatore monocomando lavello in ottone cromato con bocca girevole e doccetta estraibile.

Single lever sink mixer, chromed brass finishes. With swivel spout and pull-out spray

290-010



Miscelatore monocomando lavello in ottone cromato con bocca girevole e doccetta estraibile.

Single lever sink mixer, chromed brass finishes. With swivel spout and pull-out spray



280-010



Miscelatore monocomando lavello in ottone cromato con bocca girevole.

Single lever sink mixer, chromed brass finishes with swivel spout

3786-010



Miscelatore monocomando lavello in ottone cromato con bocca girevole.

Single lever sink mixer, chromed brass finishes with swivel spout

286-010



Miscelatore monocomando lavello in ottone cromato con bocca girevole.

Single lever sink mixer, chromed brass finishes with swivel spout

270-010



Miscelatore monocomando lavello a parete in ottone cromato con bocca girevole.

Wall single lever sink mixer, chromed brass finishes with swivel spout

571-010



Miscelatore monocomando lavello a parete in ottone cromato con bocca girevole.

Wall single lever sink mixer, chromed brass finishes with swivel spout

1660-010



Gruppo lavello a parete in ottone cromato con bocca girevole.

Wall sink mixer, chromed brass finishes with swivel spout

285-010



Miscelatore monocomando lavello in ottone cromato con bocca girevole.

Single lever sink mixer, chromed brass finishes with swivel spout

588-010



Miscelatore monocomando lavello in ottone cromato con bocca girevole.

Single lever sink mixer, chromed brass finishes with swivel spout

18082-010



Miscelatore monocomando lavello sottofinestra in ottone cromato, canna girevole telescopica.

Single lever sink mixer under window, chromed brass finishes with swivel telescopic spout

6281-010



Miscelatore monocomando lavello in ottone cromato con bocca girevole. Con attacco lavastoviglie

Single lever sink mixer, chromed brass finishes with swivel spout. With dishwasher connection

3782-010



Miscelatore monocomando lavello in ottone cromato con bocca girevole. Con attacco lavastoviglie

Single lever sink mixer, chromed brass finishes with swivel spout. With dishwasher connection

3180-010



Miscelatore monocomando lavello con acque separate in ottone cromato, bocca girevole.

Sink mixer with, chromed brass finishes swivel spout and pure water device

M Mariner - Thermomix

Forte dell'esperienza decennale nella produzione e vendita di termostatici, MARINER ha perfezionato i propri prodotti per adattarli alle normative vigenti in vari paesi sia della Comunità Europea che del resto del mondo. Questo ha permesso di acquisire un'importante spazio nel mercato della rubinetteria termostatica.

Le possibilità di installazione spaziano dai normali doccia fino ai più completi "Dual Plus" che hanno sia l'attacco per la colonna che l'uscita per la doccia.

Due to the deep experience in producing and selling thermostatics, MARINER has refined the products in order to be adapted at different standards required in several countries of the European Community and all over the world. This fact allowed MARINER to become a leader in the thermostatic market.

The range includes regular thermostatic and "Dual" thermostatic which allows a double outlet.



“Safety cartridge”

La cartuccia garantisce sicurezza per l'utente in quanto non consente che l'acqua vada oltre la temperatura di 46°C

The cartridge does not allow water to go over 46°C. This important system guarantees safety for the end user.

“Soft touch”

Il termostatico non ustiona al tatto, grazie ad un sistema di camere interne che impedisce all'acqua di entrare in contatto con la parte più esterna del corpo del miscelatore.

Thanks to a sophisticated internal system, the water does not get in contact with the external surface of the thermostatic. The end user does not get burned touching the surface.

“Safety & Comfort”

Facile e intuitiva la regolazione della temperatura. La maniglia ruota liberamente fino a raggiungere i 38°C, per aumentare il valore bisogna agire anche sul bottone in questo modo si evita un accidentale innalzamento della temperatura durante la doccia.

Temperature setting is easy and intuitive. The handle spins freely up to 38°C. If an higher temperature is desired, it is necessary to press the red button. This caution avoids accidental increase of the temperature.





7797-010MC1



Miscelatore doccia termostatico con maniglie Ring. linteramente in ottone cromato

Thermostatic wall shower mixer with brass chromed Ring handles.

7796-010MC1



Miscelatore doccia termostatico 2 vie con maniglie Ring in ottone cromato

Double outlet thermostatic wall shower mixer with brass chromed Ring handles.

7800-010MC1



Miscelatore vasca termostatico con maniglie Ring in ottone cromato

Thermostatic wall bath shower mixer with brass chromed Ring handles.

7797-010MC2



Miscelatore doccia termostatico con maniglie King in ottone cromato

Thermostatic wall shower mixer with brass chromed King handles.

7796-010MC2



Miscelatore doccia termostatico 2 vie con maniglie King in ottone cromato

Double outlet thermostatic wall shower mixer with brass chromed King handles.

7800-010MC2



Miscelatore vasca termostatico con maniglie King in ottone cromato

Thermostatic wall bath shower mixer with brass chromed King handles.



1336-000/CD



Composizione completa composta da:
 Colonna doccia telescopica a ponte con soffione Ø 200 mm, supporto regolabile con saliscendi per doccetta a 3 getti e flessibile da 150 cm.
 Miscelatore termostatico doccia a due vie con mensola portaoggetti.

*Complete set composed of:
 Telescopic shower column with Ø 200 mm shower head, adjustable bracket for up and down hand-shower 3-jets and 150 cm flexible hose.
 Two-ways thermostatic wall shower mixer with shelf.*

1331-000



Miscelatore termostatico doccia con mensola portaoggetti.
Thermostatic wall shower mixer with shelf.

1336-000



Miscelatore termostatico doccia a due vie con mensola portaoggetti.
Two-ways thermostatic wall shower mixer with shelf.



1331-010



Miscelatore doccia termostatico in ottone cromato.
Thermostatic wall shower mixer, chromed brass finishes

7097-010



Miscelatore doccia termostatico in ottone cromato.
Thermostatic wall shower mixer, chromed brass finishes

14011-010



Miscelatore doccia termostatico in ottone cromato.
Thermostatic wall shower mixer, chromed brass finishes

1336-010



Miscelatore doccia termostatico con deviatore a 2 vie in ottone cromato.
Double outlet thermostatic wall shower mixer, chromed brass finishes

1336-010FA



Miscelatore doccia termostatico con deviatore a 2 vie in ottone cromato.
Double outlet thermostatic wall shower mixer, chromed brass finishes

14036-010



Miscelatore doccia termostatico con deviatore a 2 vie in ottone cromato.
Double outlet thermostatic wall shower mixer, chromed brass finishes

1330-010



Miscelatore doccia termostatico in ottone cromato.
Attacco alto per colonna doccia

*Thermostatic wall shower mixer, chromed brass finishes.
High connection for shower column*

1367-010



Miscelatore vasca termostatico in ottone cromato.

Thermostatic wall bath shower mixer, chromed brass finishes.

1361-010



Miscelatore vasca termostatico in ottone cromato con deviatore automatico.

Thermostatic wall bath shower mixer, chromed brass finishes with automatic diverter.

1361-010/Pillars



Miscelatore vasca termostatico in ottone cromato con deviatore automatico. Con pillars per installazione a bordo vasca.

Deck mounted thermostatic bath shower mixer, chromed brass finishes with automatic diverter. With pillars.

7061-010



Miscelatore vasca termostatico in ottone cromato con deviatore automatico.

Thermostatic wall bath shower mixer, chromed brass finishes with automatic diverter.

1366-010



Miscelatore vasca termostatico in ottone cromato con deviatore. Attacco alto per colonna doccia

Thermostatic wall bath shower mixer, chromed brass finishes with diverter. High connection for shower column

7096-010



Miscelatore doccia incasso termostatico in ottone cromato.

Thermostatic built-in shower mixer, chromed brass finishes.

14042-010



Miscelatore doccia incasso termostatico in ottone cromato.

Thermostatic built-in shower mixer, chromed brass finishes.

20042-010



Miscelatore doccia incasso termostatico in ottone cromato.

Thermostatic built-in shower mixer, chromed brass finishes.

20043-010



Miscelatore doccia incasso termostatico in ottone cromato. Con deviatore 2 vie

Thermostatic built-in shower mixer, chromed brass finishes. With 2 ways diverter

19042-010



Miscelatore doccia incasso termostatico in ottone cromato.

Thermostatic built-in shower mixer, chromed brass finishes.

19043-010



Miscelatore doccia incasso termostatico in ottone cromato. Con deviatore 2 vie

Thermostatic built-in shower mixer, chromed brass finishes. With 2 ways diverter





Soffione Nr. 30



Soffione multifunzione ad incasso in acciaio inox 950x950 mm, funzione cromoterapia con telecomando. Getti pioggia spray e cascata.

Multifunction built-in shower head in stainless steel 950x950 mm, chromotherapy function with remote control. Rain jets, spray and waterfall.

Soffione Nr. 31



Soffione multifunzione ad incasso in acciaio inox 630x480 mm, funzione cromoterapia con telecomando. Getti pioggia cascata e spin rotante.

Multifunction built-in shower head in stainless steel 630x480 mm, chromotherapy function with remote control. Rain jets, waterfall and spinning spin.

Soffione Nr. 32



Soffione multifunzione ad incasso in acciaio inox 700x380 mm, funzione cromoterapia con telecomando. Getti pioggia e cascata.

Multifunction built-in shower head in stainless steel 700x380 mm, chromotherapy function with remote control. Rain jets, and waterfall.

Soffione Nr. 33



Soffione multifunzione ad incasso in acciaio inox 500x500 mm, funzione cromoterapia con telecomando. Getti pioggia spray e cascata.

Multifunction built-in shower head in stainless steel 500x500 mm, chromotherapy function with remote control. Rain jets, spray and waterfall.

Soffione Nr. 17



Soffione a parete in acciaio inox con getto a pioggia e getto a cascata 500 x 270 mm.
Stainless steel wall showerhead with waterfall jet 500 x 270 mm.

Soffione Nr. 16



Soffione a parete in acciaio inox con getto a pioggia e getto a cascata 500 x 270 mm.
Stainless steel wall showerhead with waterfall jet 500 x 270 mm.

Soffione Nr. 34



Soffioncino in acciaio inox con anticalcare, completo di braccio a soffitto lungo
Stainless steel showerhead with long ceiling arm

Soffione Nr. 35



Soffioncino in acciaio inox con anticalcare, completo di braccio a soffitto medio
Stainless steel showerhead with medium ceiling arm

Soffione Nr. 36



Soffioncino in acciaio inox con anticalcare, completo di braccio a soffitto corto
Stainless steel showerhead with short ceiling arm



Soffione Nr. 19



Soffione in acciaio inox ultrasottile con anticalcare attacco 1/2 F con snodo.

Antiscale ultra flat *stainless steel* showerhead with 1/2" F adjustable connection.

Soffione Nr. 18



Soffione in acciaio inox ultrasottile con anticalcare attacco 1/2 F con snodo.

Antiscale ultra flat *stainless steel* showerhead with 1/2" F adjustable connection.

Soffione Nr. 20



Soffione in ABS tondo 200mm con anticalcare con sistema risparmio acqua fino al 30%.

Antiscale round *ABS* showerhead 200mm with *water saving system up to 30%*

Soffione Nr. 14



Soffione classico in ottone Ø 200mm con anticalcare attacco 1/2 F con snodo.

Antiscale classic *brass* showerhead Ø200mm with 1/2" F adjustable connection.

Soffione Nr. 7



Soffione in ottone quadro 200mm con anticalcare attacco 1/2 F con snodo.

Antiscale square *ABS* showerhead 200mm with 1/2" F adjustable connection.

Soffione Nr. 11



Soffione in ottone tondo Ø 200mm con anticalcare attacco 1/2 F con snodo.

Antiscale round *ABS* showerhead Ø 200mm with 1/2" F adjustable connection.





CD06



Colonna in ottone da pavimento con rubinetto, deviatore e appendidoccia.

Brass floor column with faucet, diverter and shower support.

21008-010



Colonna in ottone da pavimento con rubinetto, deviatore e appendidoccia.

Brass floor column with faucet, diverter and shower support.

21004-010



Colonna in ottone a parete con rubinetto, deviatore e appendidoccia.

Brass wall column with faucet, diverter and shower support.



1336-010CD

Composizione completa composta da:
Colonna doccia telescopica a ponte con soffione Ø 200 mm, supporto regolabile con saliscendi per doccetta a 3 getti e flessibile da 150 cm.
Miscelatore doccia termostatico con deviatore a 2 vie in ottone cromato.

*Complete set composed of:
Telescopic shower column with Ø 200 mm shower head, adjustable bracket for up and down hand-shower 3-jets and 150 cm flexible hose.
Double outlet thermostatic wall shower mixer, chromed brass finishes*

CD09



Colonna doccia telescopica a ponte con soffione Ø 200 mm, supporto regolabile con saliscendi per doccetta a 3 getti e flessibile da 150 cm.

Telescopic shower column with Ø 200 mm shower head, adjustable bracket for up and down hand-shower 3-jets and 150 cm flexible hose.

CD05



Colonna doccia telescopica a ponte con soffione rettangolare 140x200 mm, supporto regolabile con saliscendi per doccetta monogetto e flessibile da 150 cm.

Telescopic shower column with 140x200 mm shower head, adjustable bracket for up and down hand-shower 1-jet and 150 cm flexible hose.

CD04



Colonna doccia telescopica curva con soffione Ø 200 mm, supporto regolabile con saliscendi per doccetta minimal monogetto e flessibile da 150 cm.

Curved telescopic shower column with Ø 200 mm shower head, adjustable bracket for up and down minimal hand-shower 1-jets and 150 cm flexible hose.

CD08



Colonna doccia telescopica curva con soffione Ø 200 mm, supporto regolabile con saliscendi per doccetta monogetto e flessibile da 150 cm.

Curved telescopic shower column with Ø 200 mm shower head, adjustable bracket for up and down hand-shower 1-jet and 150 cm flexible hose.



Saliscendi Nr. 1



Saliscendi asta Ø18 mm lunghezza 61 cm. Scorrevole a maniglia in ABS. Doccetta minimal monogetto e flessibile da 150 cm.

Sliding rail bar Ø18 mm overall length 61 cm. Sliding part in ABS. Minimal hand-shower 1-jets and 150 cm flexible hose.

Saliscendi Nr. 12



Saliscendi completamente in ottone, asta Ø12 mm. Lunghezza totale 75 cm. Scorrevole a maniglia in ottone e supporti regolabili. Doccetta minimal monogetto e flessibile da 150 cm.

Sliding rail completely all brass bar Ø12 mm overall length 75 cm. Sliding part in brass and adjustable supports. Minimal hand-shower 1-jets and 150 cm flexible hose.

Saliscendi Nr. 8



Saliscendi tutto in ottone asta Ø18 mm lunghezza totale 62 cm. Doccetta classica monogetto e flessibile da 150 cm.

Sliding rail all in brass bar Ø18 mm overall length 62 cm. Classic hand-shower 1-jets and 150 cm flexible hose.

Saliscendi Nr. 23



Saliscendi asta \varnothing 25 mm lunghezza totale 71 cm. Scorrevole a pulsante in ABS con supporto regolabile. Doccia idromassaggio anticalcare 3 getti in ABS con sistema risparmio acqua fino al 30%, flessibile da 150 cm.

Sliding rail bar \varnothing 25 mm overall length 71 cm. sliding part in ABS with adjustable support. 3 jets hydromassage ABS handshower with rubber clean - Water saving system up to 30, 150 cm flexible hose.

Saliscendi Nr. 22



Saliscendi, asta \varnothing 18 mm, lunghezza totale 83 cm. Scorrevole a maniglia. Doccia idromassaggio anticalcare multi getto in ABS, flessibile da 150 cm.

Sliding rail bar \varnothing 18 mm overall length 83 cm. Sliding part in abs. Multi-rain ABS handshower with rubber clean, 150 cm flexible hose.

Saliscendi Nr. 20



Saliscendi, asta \varnothing 25 mm, lunghezza totale 83 cm. Scorrevole a maniglia. Doccia idromassaggio anticalcare multi getto in ABS, flessibile da 150 cm.

Sliding rail bar \varnothing 25 mm overall length 83 cm. Sliding part in abs. Multi-rain ABS handshower with rubber clean, 150 cm flexible hose.

Saliscendi Nr. 14



Saliscendi asta \varnothing 25 mm lunghezza totale 63 cm scorrevole a maniglia in ABS. Doccia idromassaggio anticalcare multi getto in ABS, flessibile da 150 cm.

Sliding rail bar \varnothing 25 mm overall length 63 cm. sliding part in ABS. Multi-rain ABS handshower with rubber clean, 150 cm flexible hose.





Kit 11

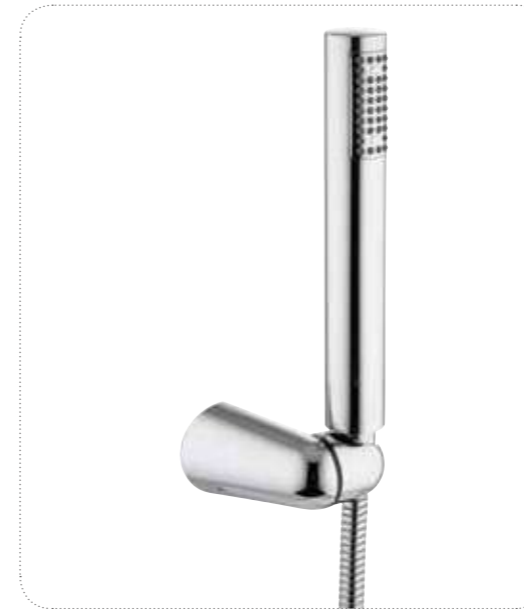

Doccia minimal anticalcare monogetto in ABS, flessibile da 150 cm, supporto snodato.

Minimal handshower with rubber clean, 150 cm flexible hose, adjustable wall bracket.

Kit 12



Doccia minimal anticalcare monogetto in ABS, flessibile da 150 cm, supporto snodato.

Minimal handshower with rubber clean, 150 cm flexible hose, adjustable wall bracket.

Kit 23



Doccia idromassaggio anticalcare 3 getti in ABS con sistema risparmio acqua fino al 30%, flessibile da 150 cm, supporto snodato.

3 jets hydromassage ABS handshower with rubber clean - Water saving system up to 30, 150 cm flexible hose, adjustable wall bracket.

Kit 20



Doccia idromassaggio anticalcare multi getto in ABS, flessibile da 150 cm, supporto snodato.

Multi-rain ABS handshower with rubber clean, 150 cm flexible hose, adjustable wall bracket.

Kit 14



Doccia idromassaggio anticalcare multi getto in ABS, flessibile da 150 cm, supporto snodato.

Multi-rain ABS handshower with rubber clean, 150 cm flexible hose, adjustable wall bracket.

Kit 24



Doccia idromassaggio anticalcare multi getto in ABS, flessibile da 150 cm, supporto snodato.

Multi-rain ABS handshower with rubber clean, 150 cm flexible hose, adjustable wall bracket.

Kit 22



Doccia idromassaggio anticalcare multi getto in ABS, flessibile da 150 cm, supporto snodato.

Multi-rain ABS handshower with rubber clean, 150 cm flexible hose, adjustable wall bracket.

Kit 19

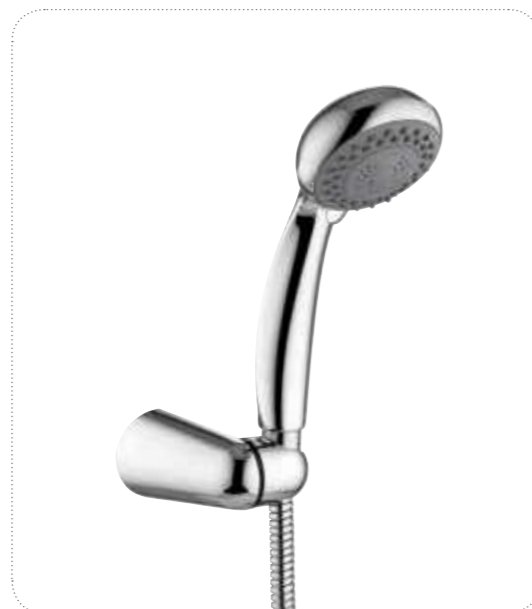

Doccia idromassaggio anticalcare multi getto in ABS, flessibile da 150 cm, supporto snodato.

Multi-rain ABS handshower with rubber clean, 150 cm flexible hose, adjustable wall bracket.

Kit 7



Doccia anticalcare monogetto in ABS, flessibile da 150 cm, supporto snodato.

1 jet ABS handshower with rubber clean, 150 cm flexible hose, adjustable wall bracket.

Kit 8



Doccia anticalcare monogetto in ottone

1 jet brass handshower with rubber clean, 150 cm flexible hose, adjustable wall bracket.

Kit 21

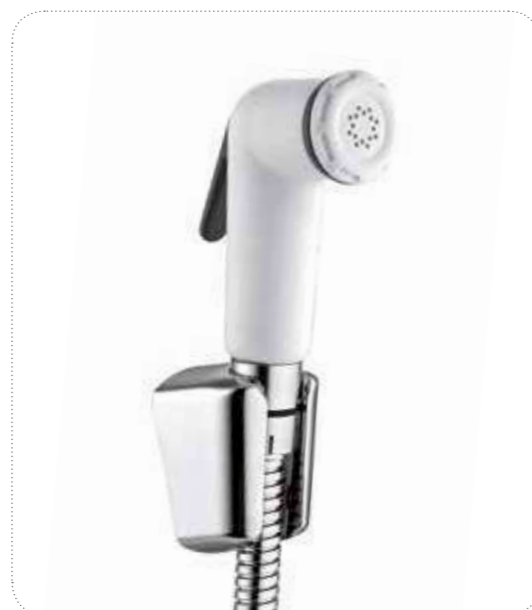

Doccia shut-off in ABS, flessibile da 120 cm, supporto fisso

ABS shut-off shower, 120 cm flexible hose, fixed wall bracket.

Kit 30



Set idroscopino con doccia, rubinetto in ottone cromato, flessibile doppia aggraffatura cm 120.

Hydrobrush jet set with handshower, brass chrome plated tap, flexible hose double lock 120cm.

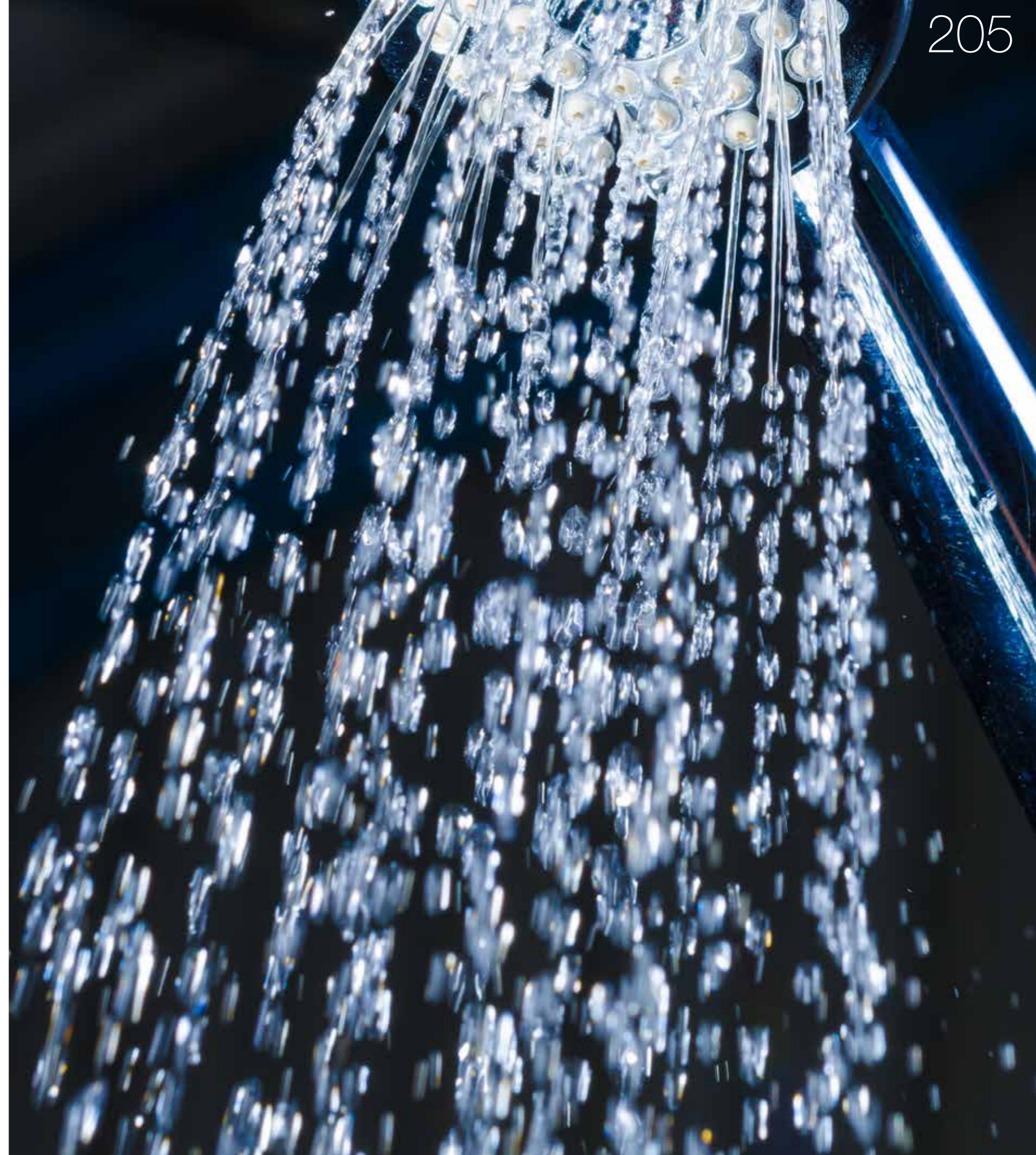



86106



Porta sapone a parete con piatto in vetro
Wall mounted soap holder with frosted glass

86108



Porta spazzolino a parete con bicchiere in vetro
Wall mounted tumbler holder with frosted glass

86104



Portasalviette ad anello a parete Ø 20 cm
Wall mounted Ø 20 cm towel ring

86101 - 86102 - 86103

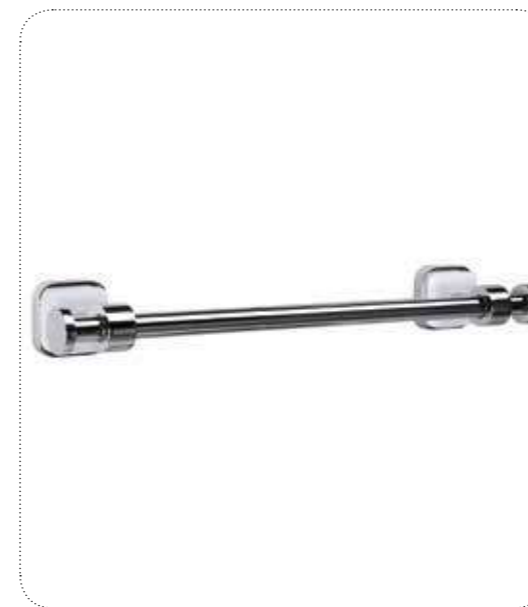

Portasalviette a parete - Wall mounted towel rail

86101 30cm
86102 40cm
86103 60cm

86107



Appendino a parete

Wall mounted robe hook

86105



Portarotolo a parete

Wall mounted paper holder



72106



Porta sapone a parete con piatto in vetro
 Wall mounted soap holder with frosted glass

72108



Porta spazzolino a parete con bicchiere in vetro
 Wall mounted tumbler holder with frosted glass

72104



Portasalviette ad anello a parete Ø 20 cm
 Wall mounted Ø 20 cm towel ring

72101 - 72102 - 72103



Portasalviette a parete - Wall mounted towel rail

72101 30cm
 72102 40cm
 72103 60cm

72107



Appendino a parete
 Wall mounted robe hook

72105



Portarotolo a parete
 Wall mounted paper holder



106



Porta sapone a parete con piatto in vetro
 Wall mounted soap holder with frosted glass

108



Porta spazzolino a parete con bicchiere in vetro
 Wall mounted tumbler holder with frosted glass

104



Portasalviette ad anello a parete Ø 20 cm
 Wall mounted Ø 20 cm towel ring

101



Portasalviette a parete 30cm
 Wall mounted 30 cm towel rail

102



Portasalviette a parete 40cm
 Wall mounted 40 cm towel rail

103



Portasalviette a parete 60cm
 Wall mounted 60 cm towel rail

110



Portarotolo a parete con coperchio
Wall mounted paper holder with cover

109



Portascopino a parete con bicchiere in vetro
Wall mounted toilet brush holder with frosted glass

105



Portarotolo a parete
Wall mounted paper holder

107



Appendino a parete
Wall mounted robe hook



M Categorie - Categories

Miscelatori
Mixers



Page 22 380 44 60 70 78 86 94
98 102 108 116 118 122 124
128 130 132

Tradizionali
Traditionals



Page 30 50 54 60 138 146 154
160

Rubinetteria in resina o legno
Wood or resin taps



Page 22 38 44

Soffioni Multifunzione
Multifunctions system



Page 189

Soffioni
Shower heads



Page 190 192

Colonne doccia
Shower columns



Page 195 196 197

Lavabo ad incasso
Built-in washbasin



Page 31 55 61 79 87 95 99 109

Rubinetteria da pavimento
Freestanding



Page 65 80 109

Rubinetteria bordo vasca
Deck mounted



Page 32 96 100 111 140 157

Saliscendi
Sliding rails



Page 199 200

Kit doccia
Handshower kit



Page 203 204

Accessori bagno
Accessories



Page 206

Termostatici
Thermostatics



Page 174

Cucina
Kitchen



Page 164

Cucina con doccia estraibile
Kitchen with extractable shower



Page 169



Mariner Rubinetterie srl
SS 33 del Sempione,
28883 Gravellona Toce (VB) Italia
tel +39 0323865049
info@mariner.it



@Mariner.rubinetterie



mariner_rubinetterie





www.mariner.it