



OIOOLI
RUBINETTERIE

BATHROOM & KITCHEN
COLLECTIONS
2026

OIOLI

Sixty years of italian style, crafted into details that define
the most exclusive bathroom spaces.

12
HOP!

Design by
Alessandra Bertini



54
ÉLITE



130
GLAM

Design by
Giacomo Zucchi



144
ZEN

Design by
Giacomo Zucchi



CITYLIFE
80

316 Stainless Steel



LIFE
104

316 Stainless Steel

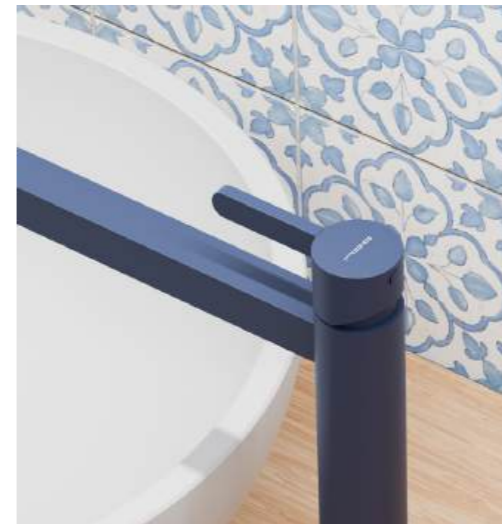

cheBELLA
158



TIKI
166

184
ZIMI



190
NOLI



224
NAVONA



232
COMO

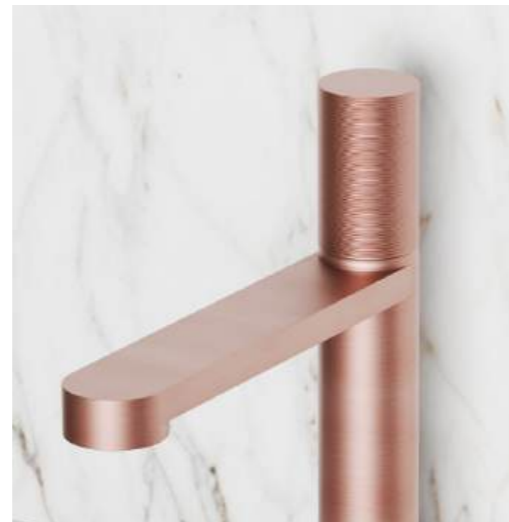

MYLOS
202

NYLOS
210

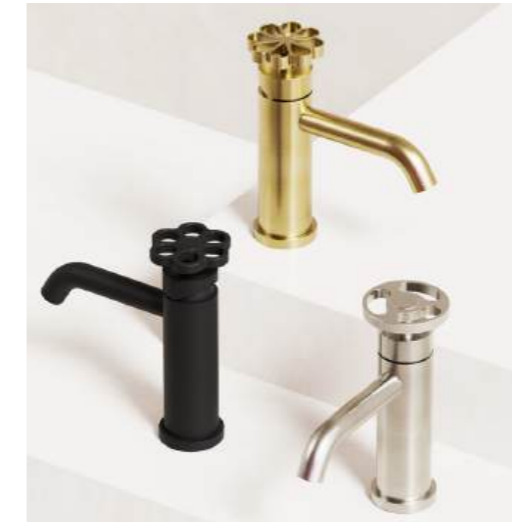

5TH AVENUE
246

PURA
290

298
MICRO



340
KREO



378
JAZZ



386
SPRITZ



STILO
360



MIRAME
370



KING
394



VIDA
400

408
MIAMI



418
OPÉRA



442
LIBERTY



448
ROME



LONDON
426



ARCANA
436



MELODY
456



KITCHEN
462

HOP!

Design by Alessandra Bertini

Where simplicity meets distinction.

A name that is already a gesture: **HOP!**
An invitation to rise, to take a leap toward something more.



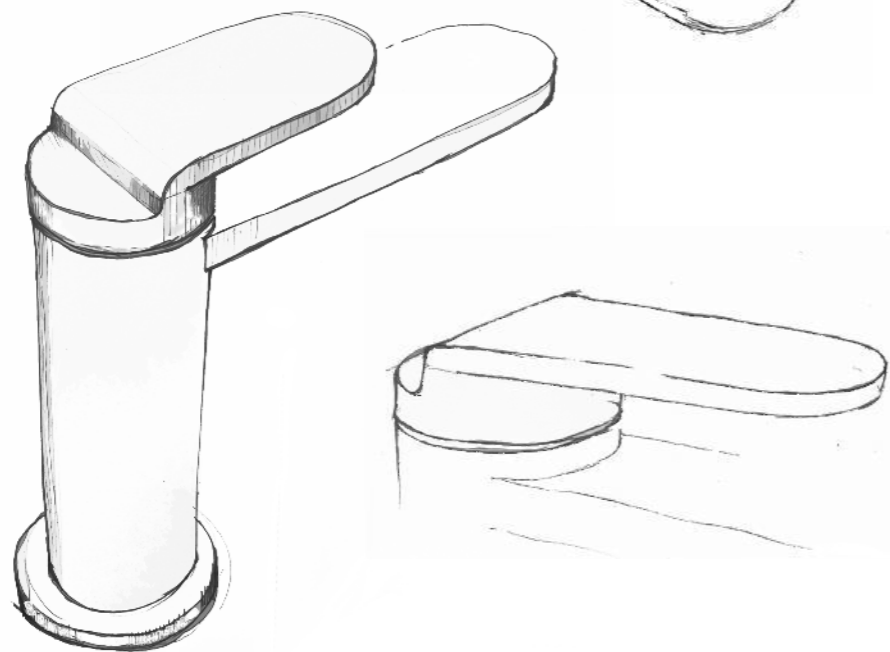
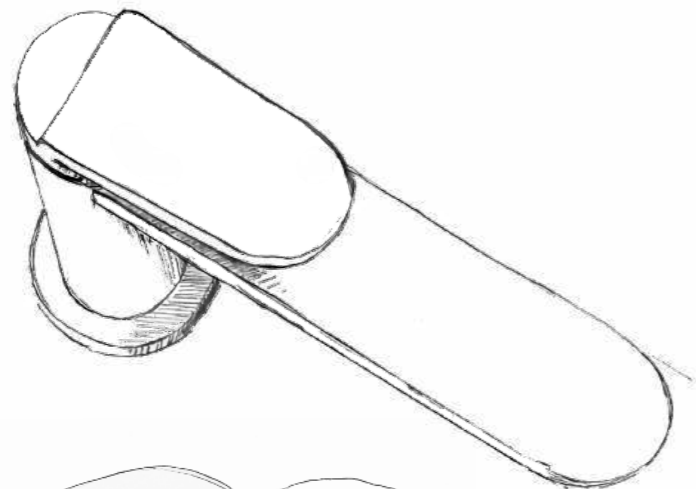

Hop was conceived with the idea of transforming a simple tap into a distinctive design statement. A product that expresses personality while remaining true to pure, essential forms. Clean lines, balanced proportions, and a bold design detail that confidently breaks the pattern.

The concept of the “leap” takes shape in the lever: anchored beyond the midpoint of the rotation control, it creates a distinctive step. A deliberate, carefully engineered feature that becomes the collection’s signature and defining element.

Slim and essential, Hop combines formal precision with a sense of dynamism. An object that does not simply complete the bathroom space, but defines it.



ALESSANDRA BERTINI

Architect and designer, my professional profile is defined by a set of complementary and integrated competencies.

From an early age, I developed a strong passion for design, which led me to pursue an academic path culminating in a Master’s Degree in Architecture from the University of Florence, awarded with highest honors, followed by professional licensure.

In **2006**, I co-founded **Phicubo**. In **2021**, a particularly significant project represented a pivotal moment in my career, prompting me to establish an independent design practice and to found **Boom Studio**, dedicated to architectural design.

My design methodology is grounded in a measured balance between creativity, emotional sensitivity, and technical rigor, always supported by a thoughtful and informed dialogue with the client.

I approach each project as a narrative process an opportunity to translate memory and identity into spatial form. Humor and lightness are consciously employed as drivers of innovation, while functionality and sustainability remain central to every intervention.

My concepts originate from emotional insights, carefully observed details, and meaningful memories, evolving into spaces that are essential, welcoming, and enduring.

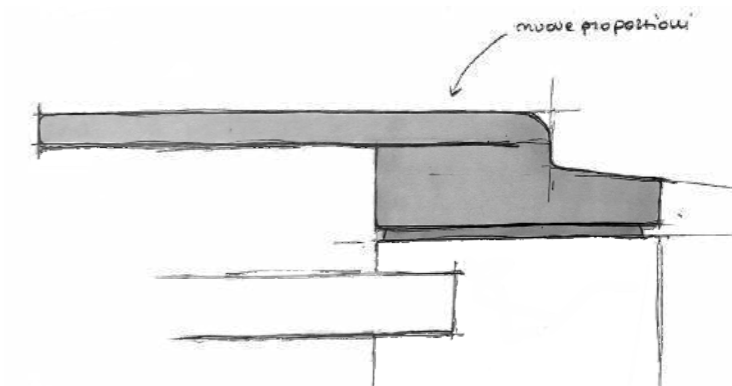

H O P !

"Where dynamic form meets the intensity
of matt blue."

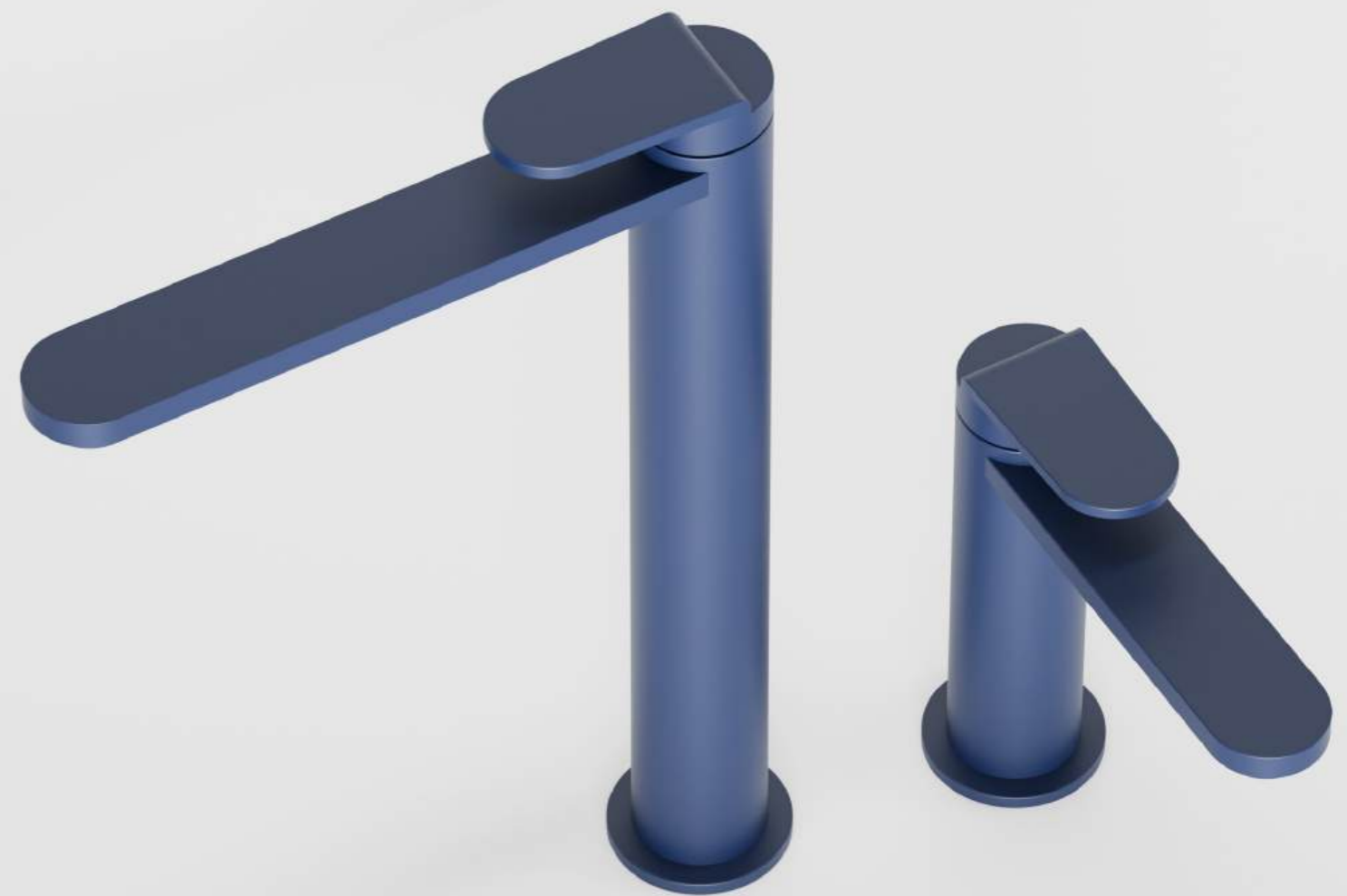

HOP!



HOP!

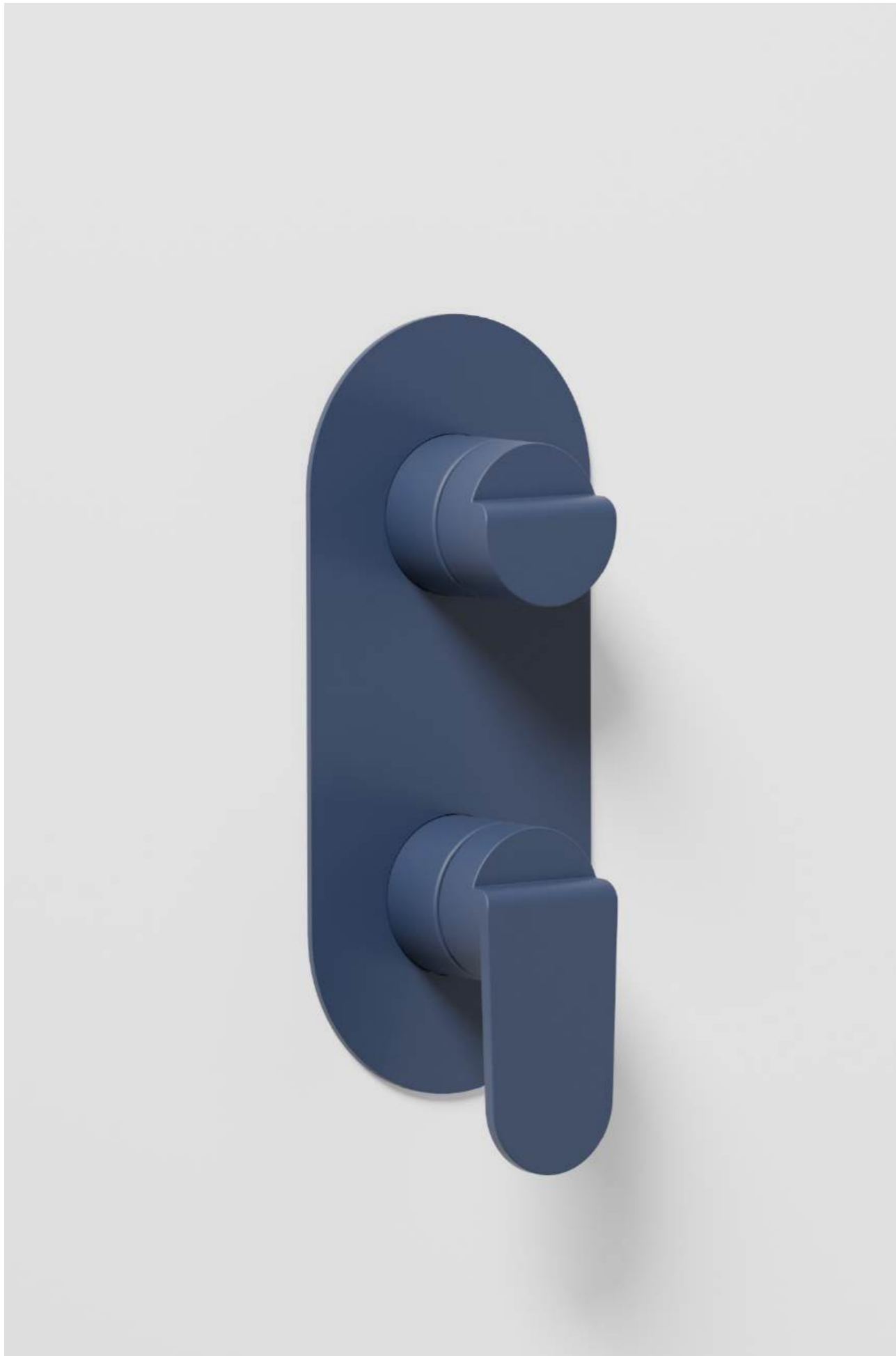

H O P !

“Where a single gesture becomes pure energy.”



HOP!



HOP!



HOP!



H O P !

"Clean lines and exposed pipes
turn functionality into pure design."



HOP!



HOP!

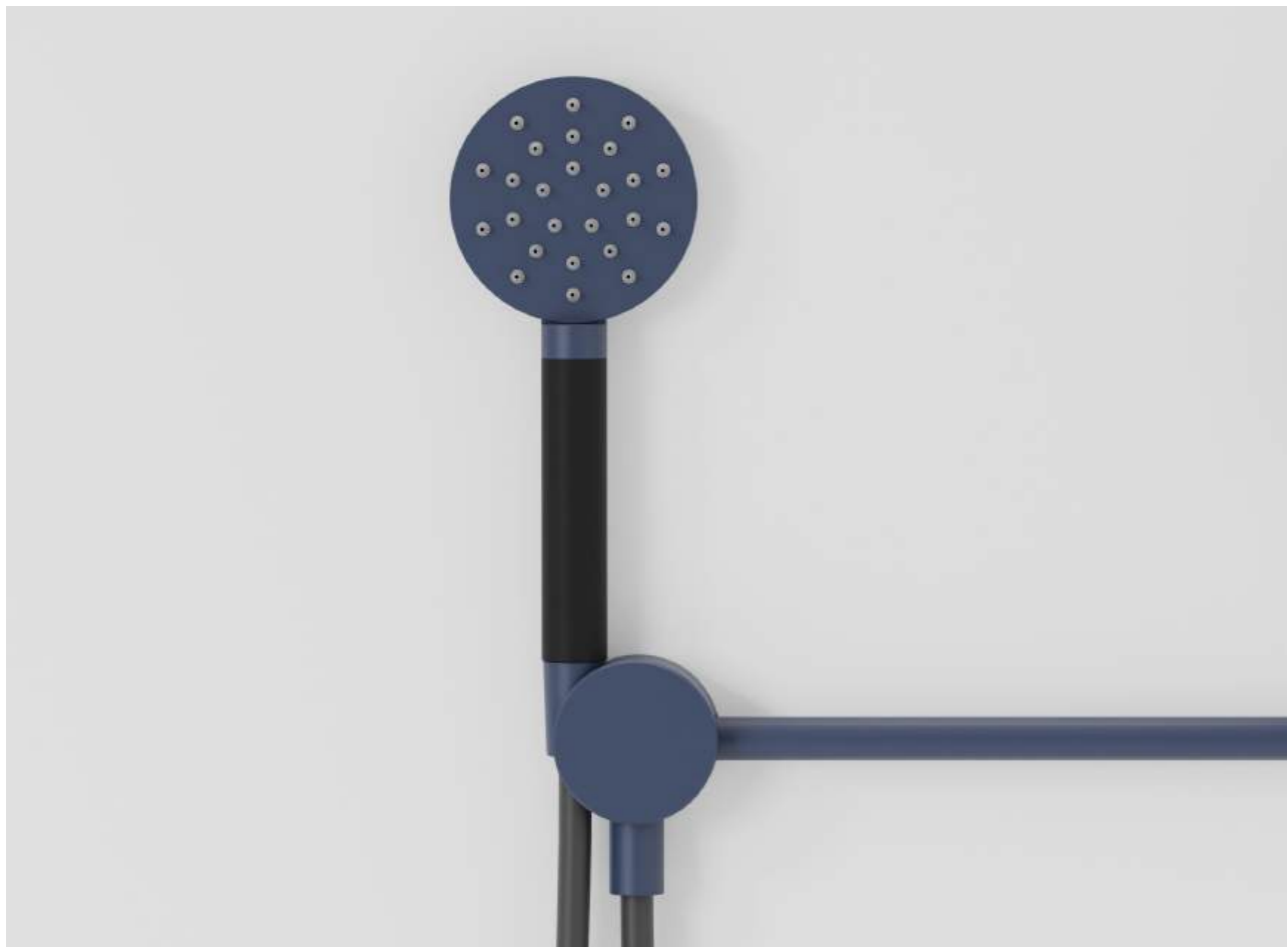

HOP!

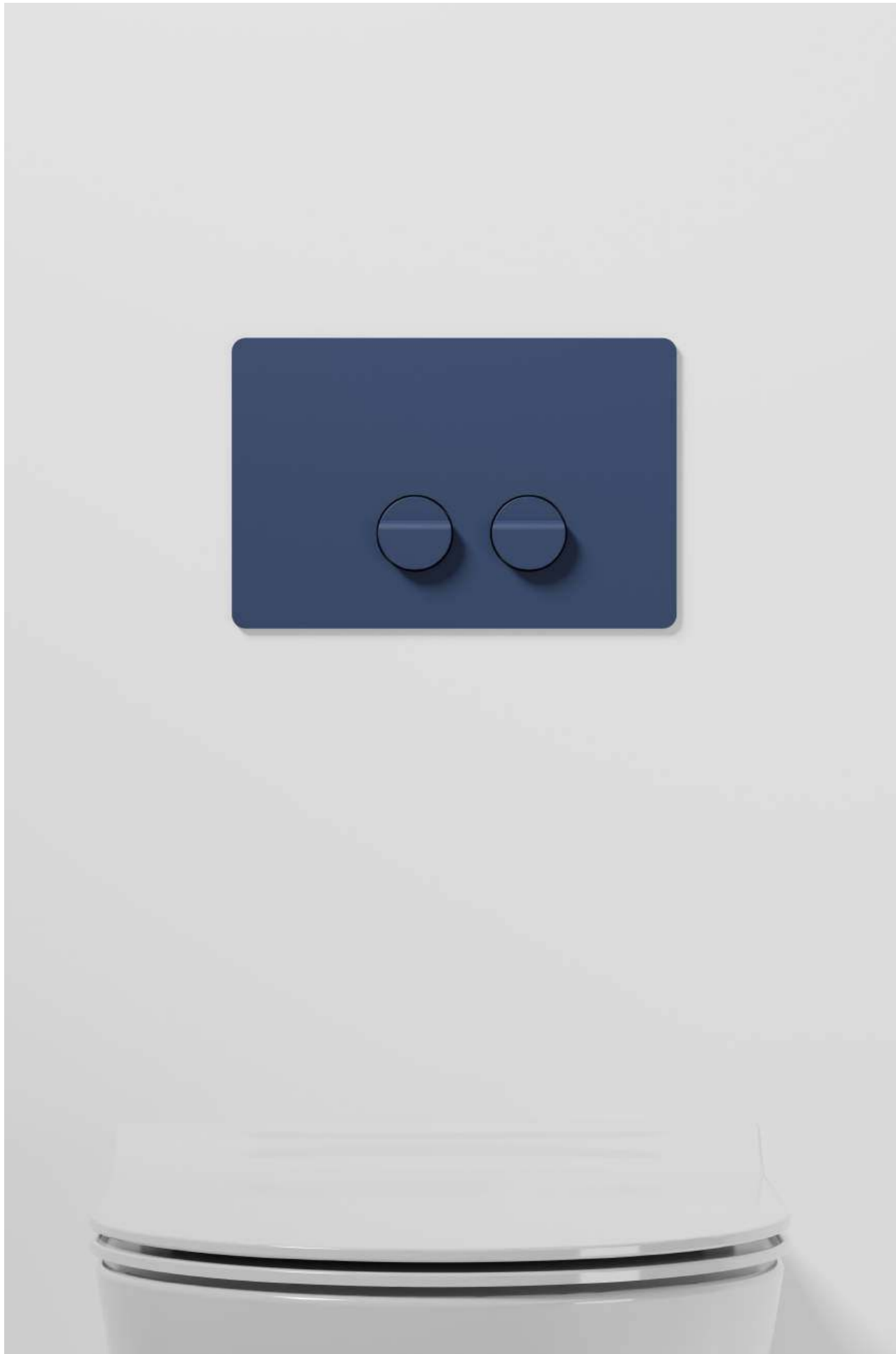

HOP!



HOP!



HOP!



H O P !

"Take the leap. Choose your color."



HOP!



HOP!



HOP!



H O P !

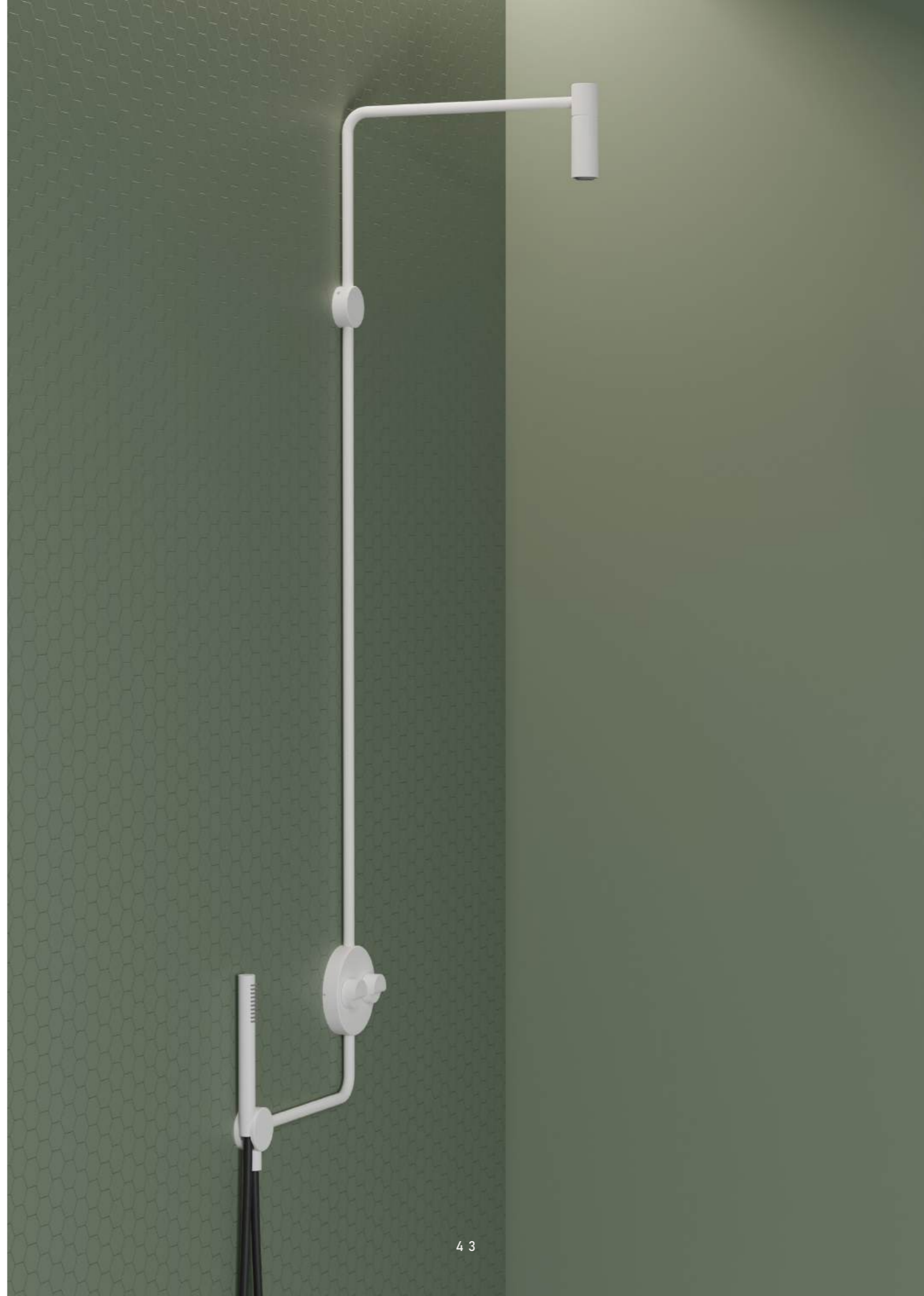

H O P !

"A bold jump in color, a statement in design."



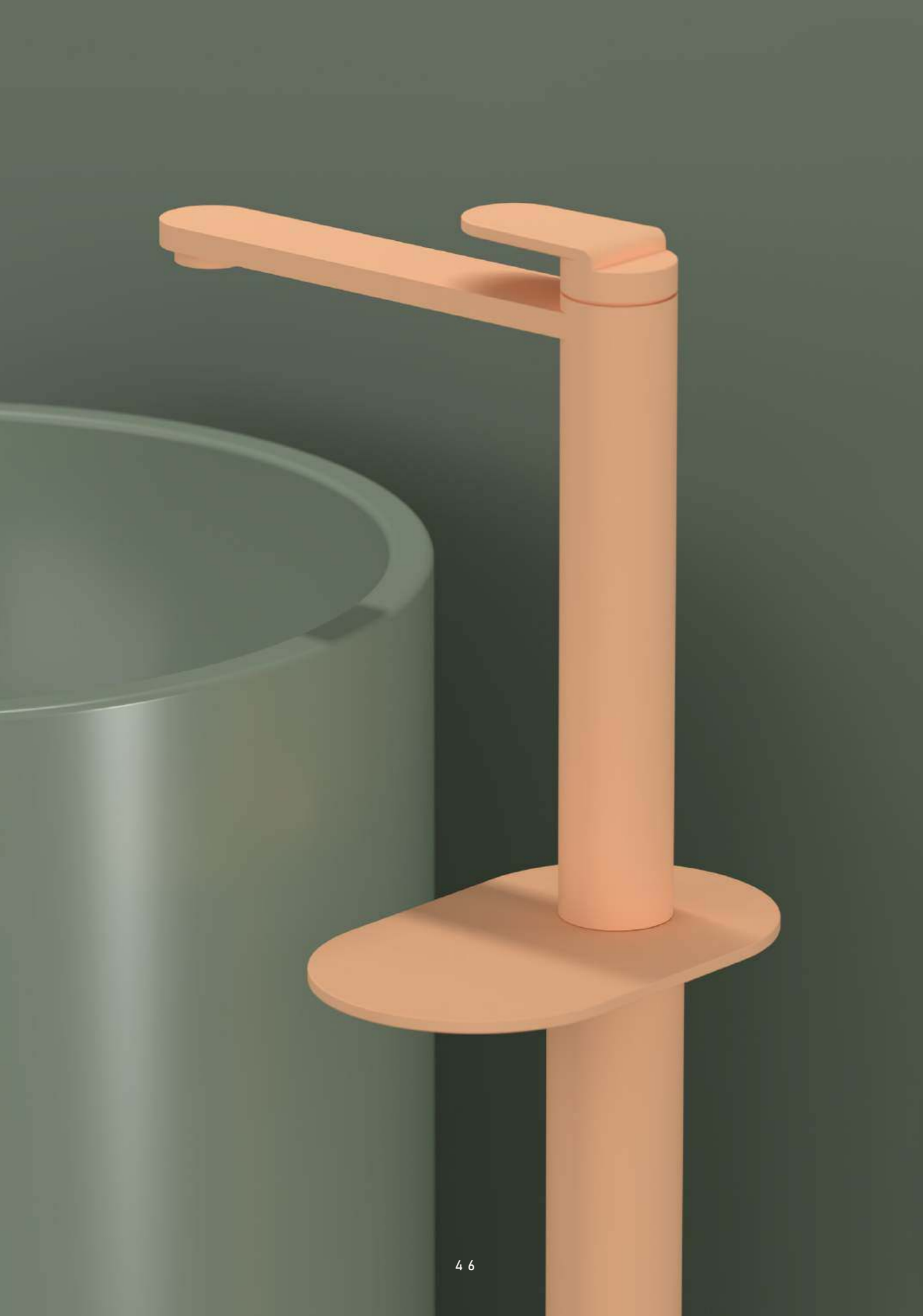

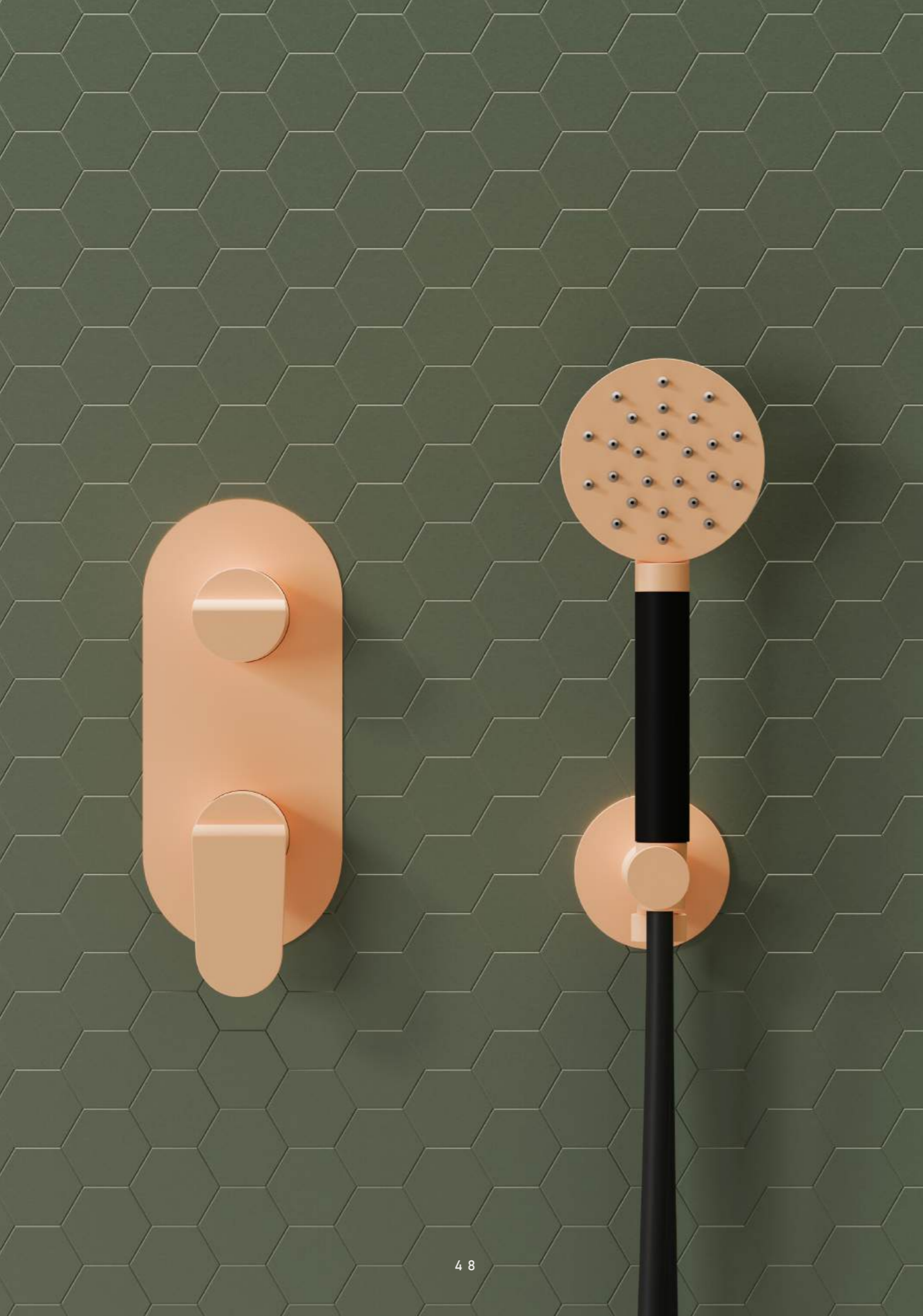

HOP!



HOP!



HOP!



ÉLITE

The elegance of essentials

A perfect balance of modernity and sophistication. The new **ÉLITE** faucet series embodies discreet luxury with clean lines and a minimalist design, enhanced by an exclusive detail: an handle inspired by the purity of faceted gemstones. A refined touch that catches the light and elevates any space, turning water into a statement of style.





ÉLITE

"A diamond of light,
whispering brilliance in brushed gold."



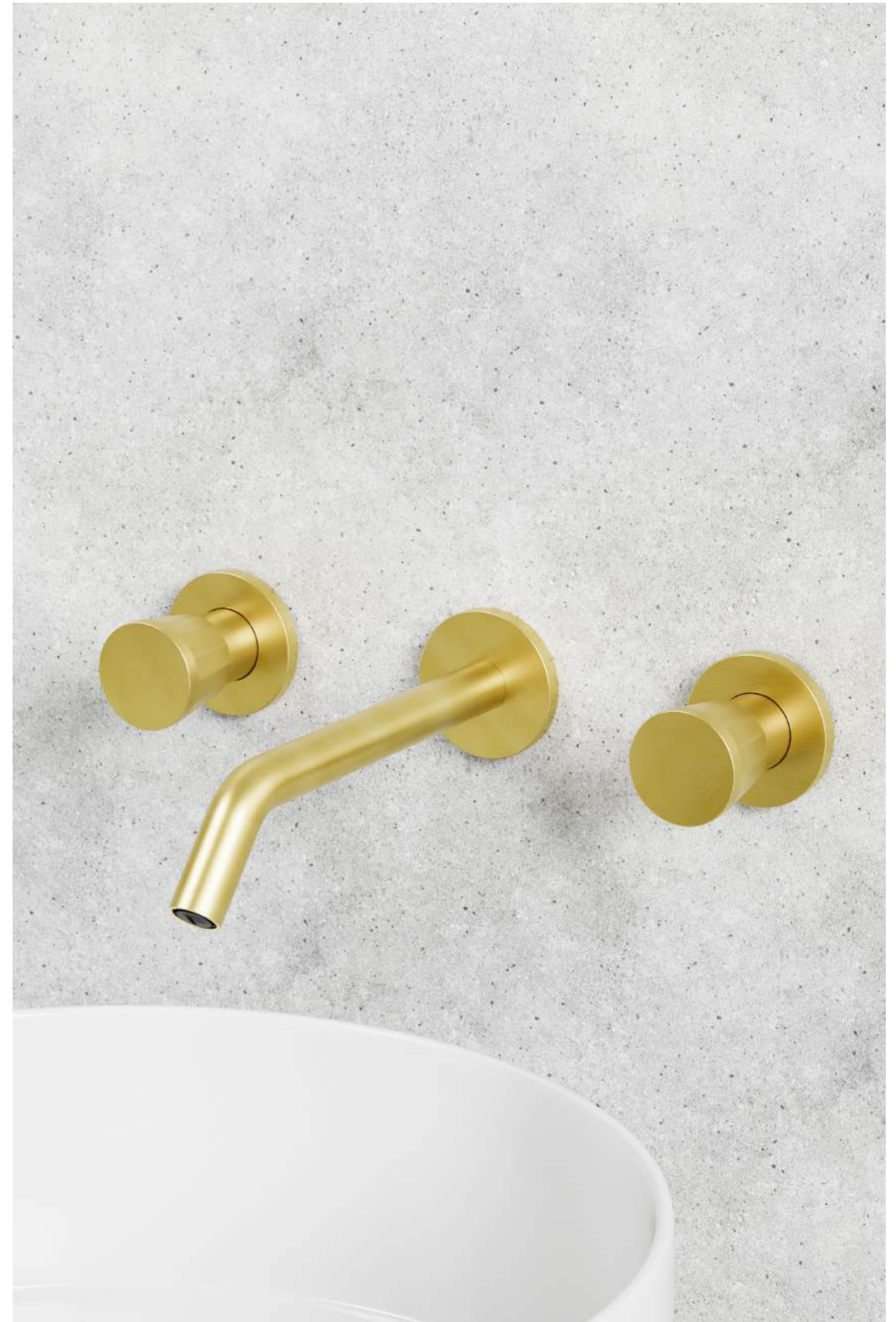

ÉLITE

“An icon of refined craftsmanship, where faceted design and noble finishes define a new standard of excellence.”



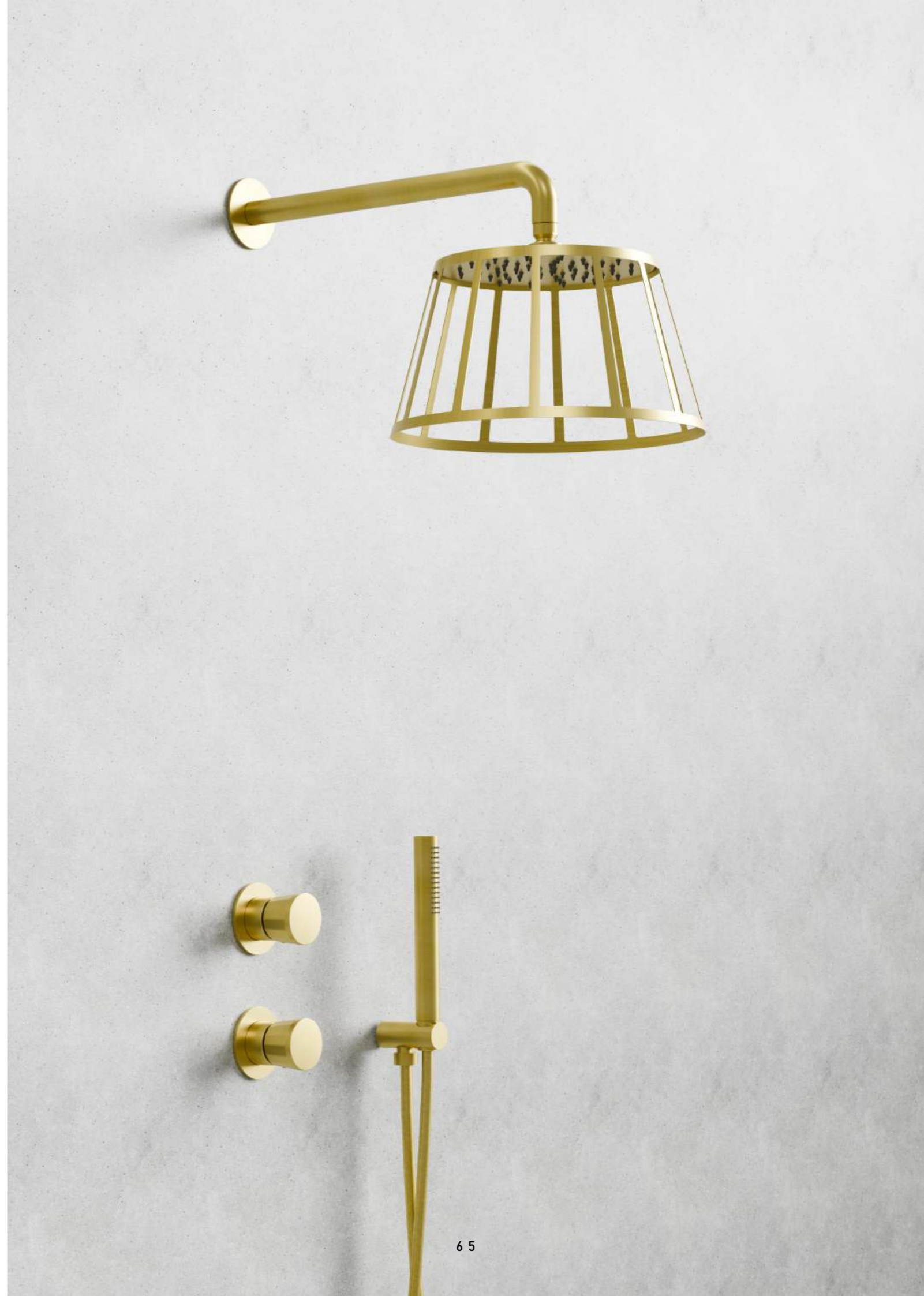

ÉLITE

"Where the art of fine jewelry meets the purity of water, crafted to embody timeless prestige."





ÉLITE

"A masterpiece of light, exquisitely faceted and adorned in brushed chrome."





ÉLITE

"Where water meets precious metal,
and every gesture becomes a ritual of radiance."

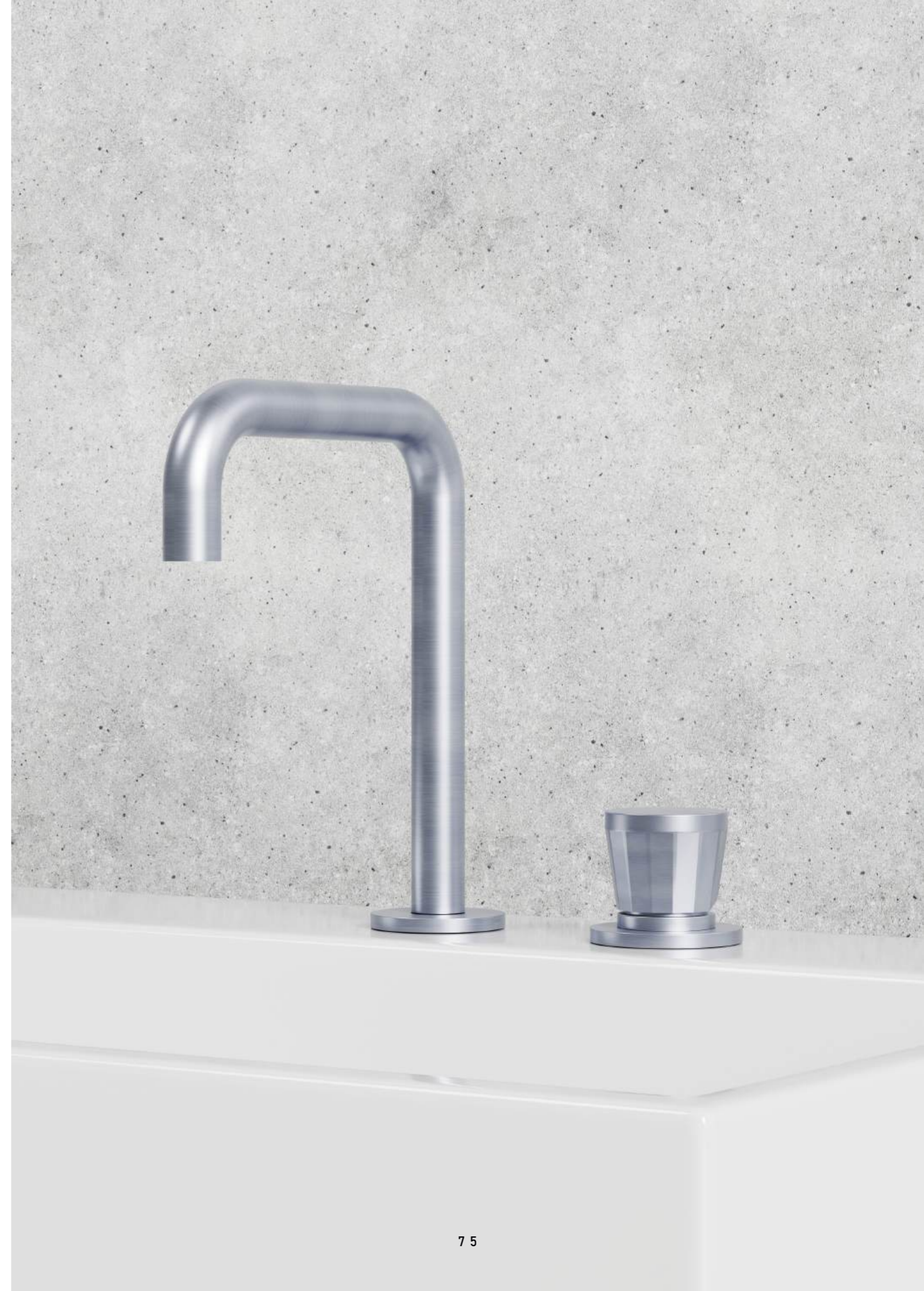





CITYLIFE

316 Stainless Steel

The Joyful Spirit of Urban Living

Inspired by the energy of modern apartments, **CITY LIFE** brings a fresh youthful touch to contemporary spaces. Crafted in sleek stainless steel, its minimalist design reflects global trends with a light and joyful spirit.

Pure lines, effortless elegance, and a modern attitude,
perfect for those who love city living with style.











CITYLIFE

"Pure form. Urban strength."

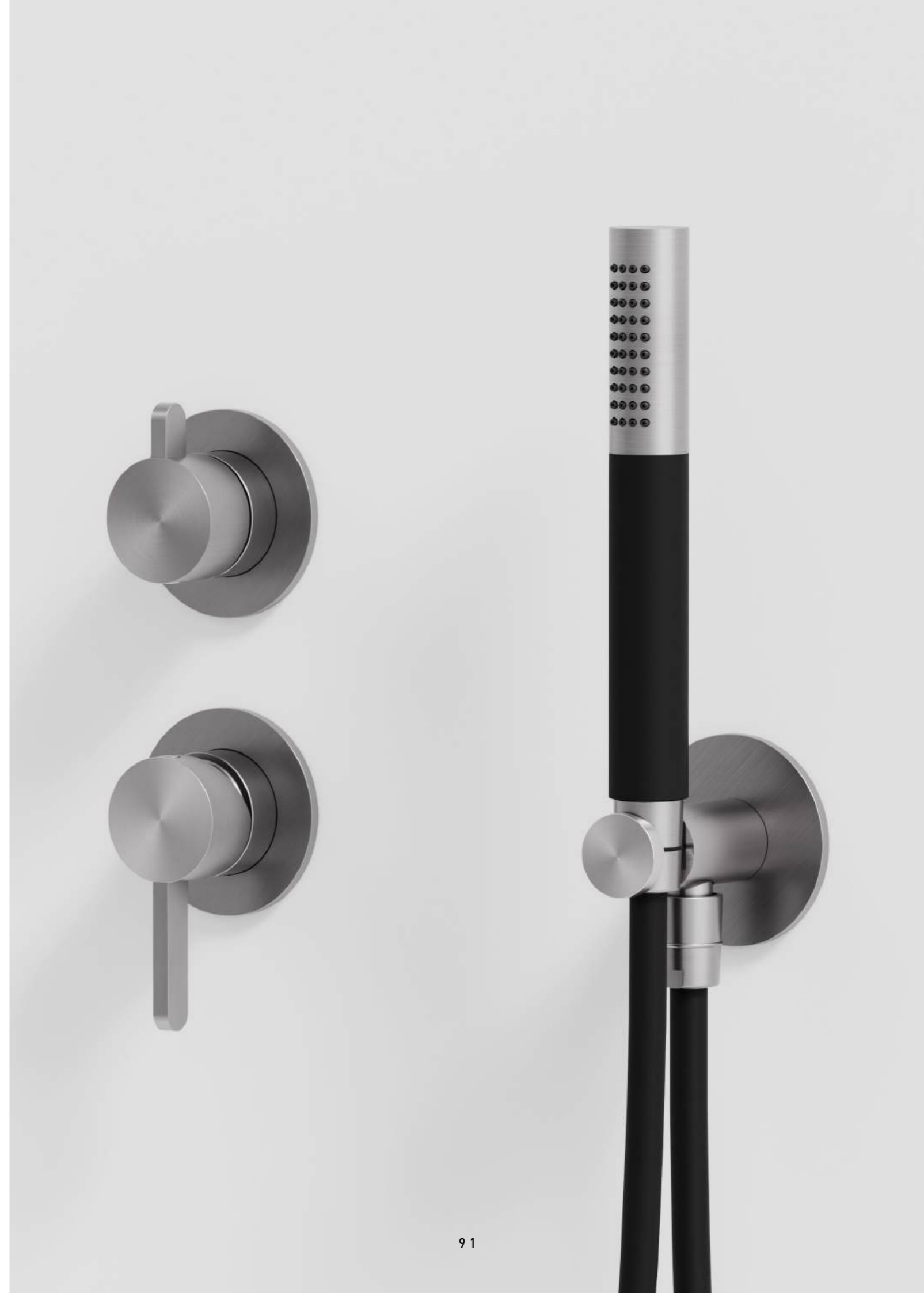

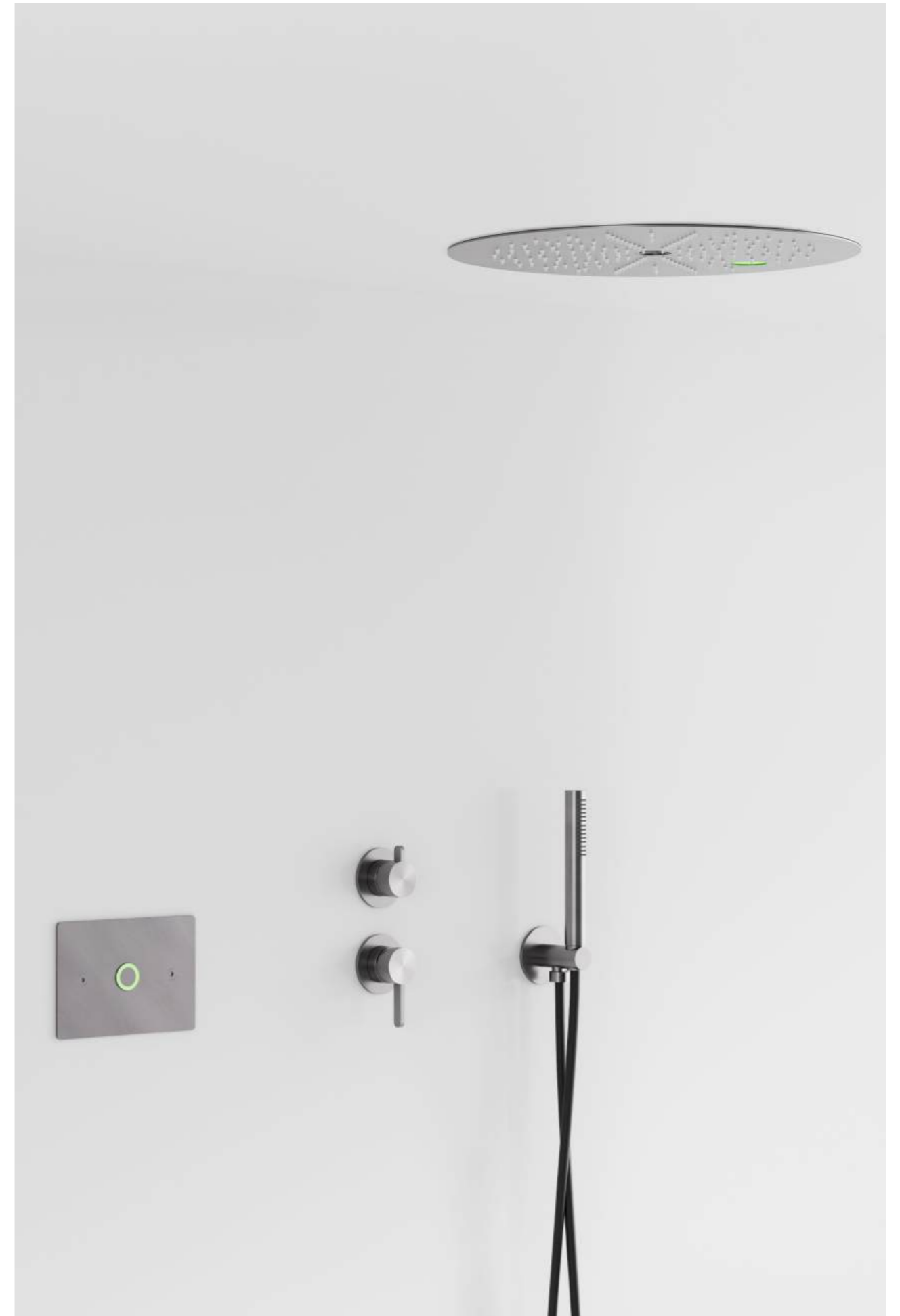
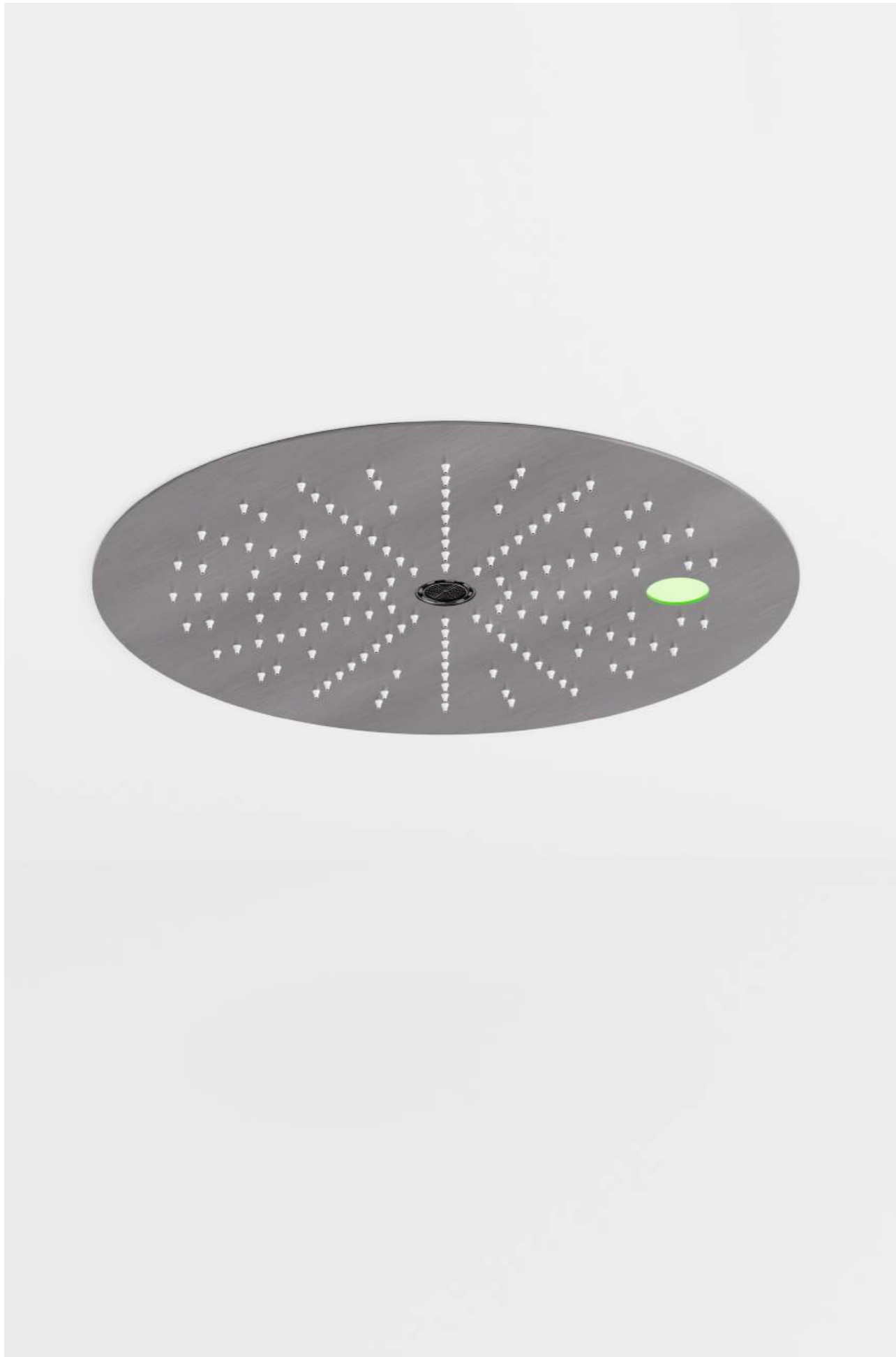



CITYLIFE

"Precision in 316. Purity in form."





CITYLIFE

"Where stainless steel meets modern attitude"





LIFE

316 Stainless Steel

Strength, durability, and pure design

LIFE is the faucet collection that revolutionizes everyday living. Crafted entirely from stainless steel, it offers unmatched resistance, a modern aesthetic, and an eco-friendly soul. A perfect balance of innovation and elegance, designed for those who demand the best in every detail.





STAINLESS STEEL IS THE NEW ERA.

With PVD finishing, it transforms into a range of emotional colors, bringing style and personality to any space.

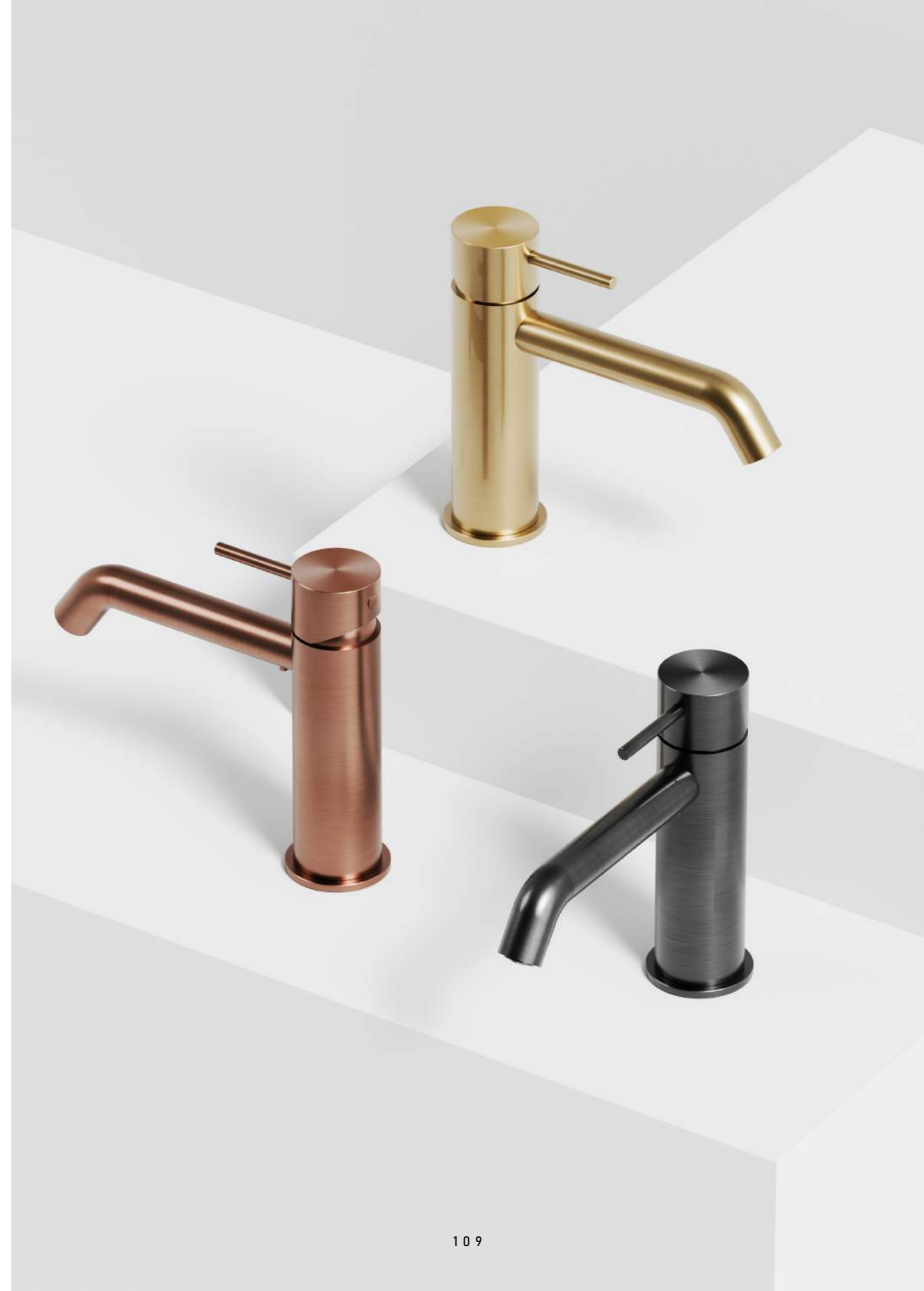

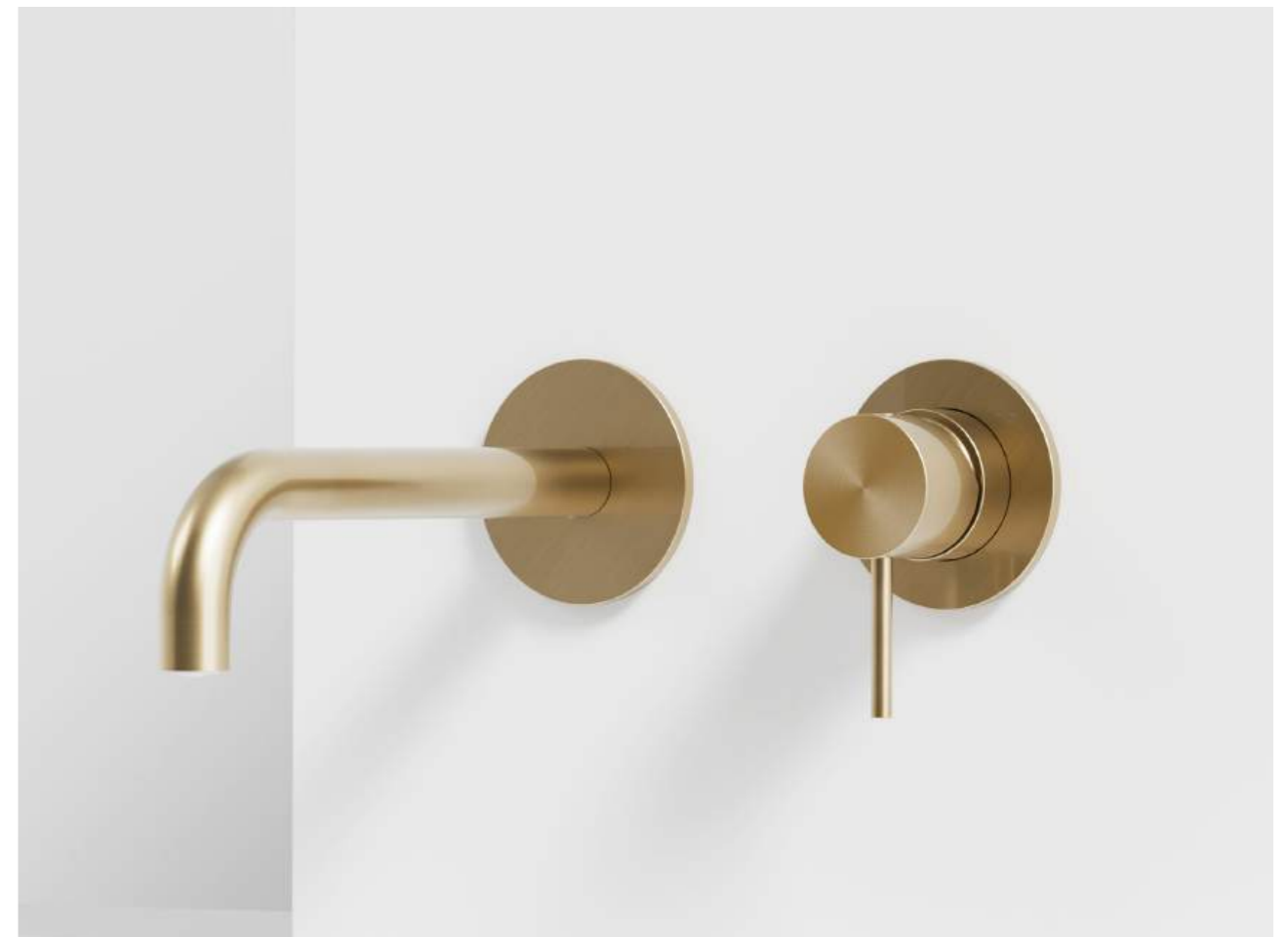



L I F E

"Timeless design forged in steel."







L I F E

“Timeless style, endless emotions”





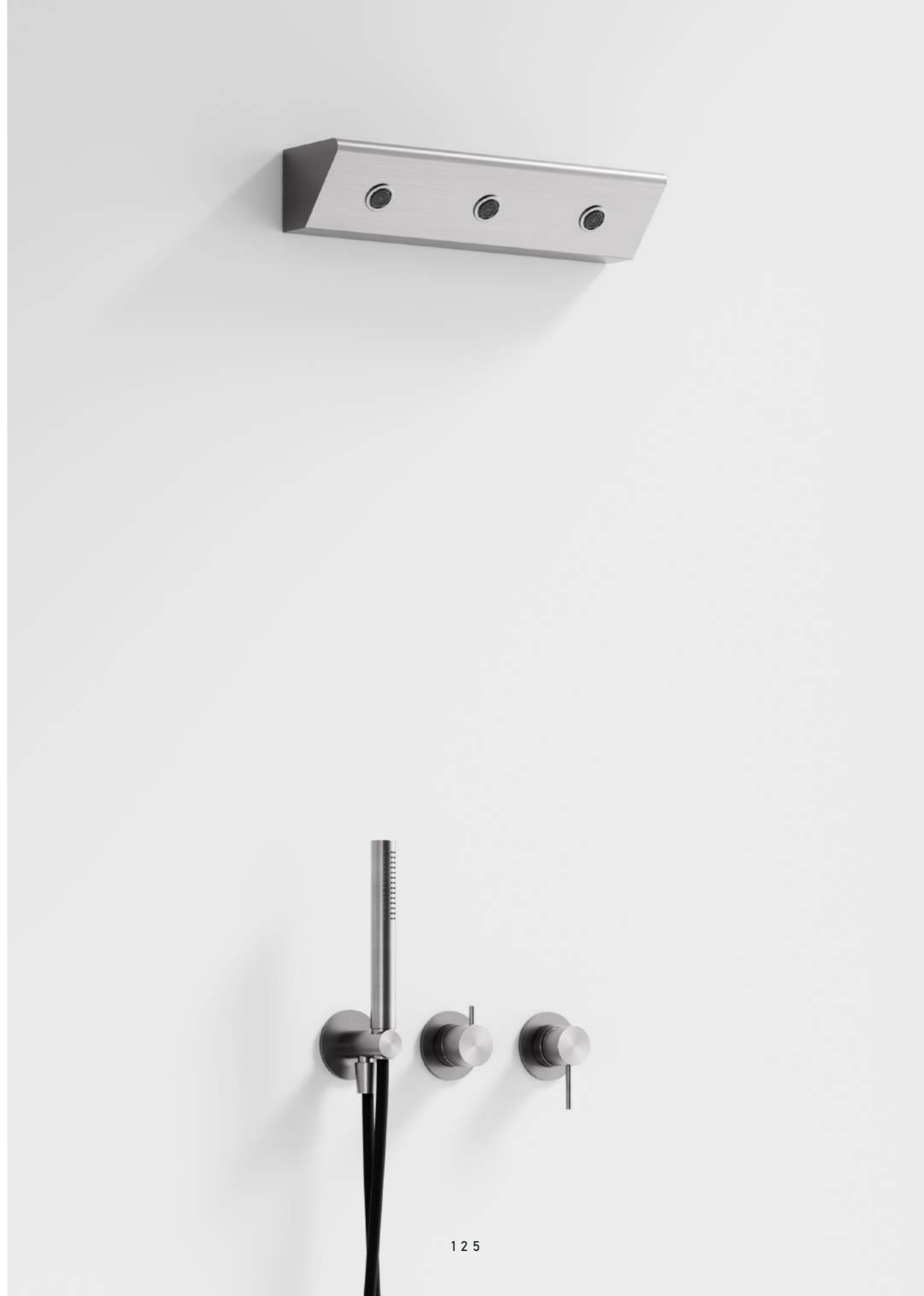

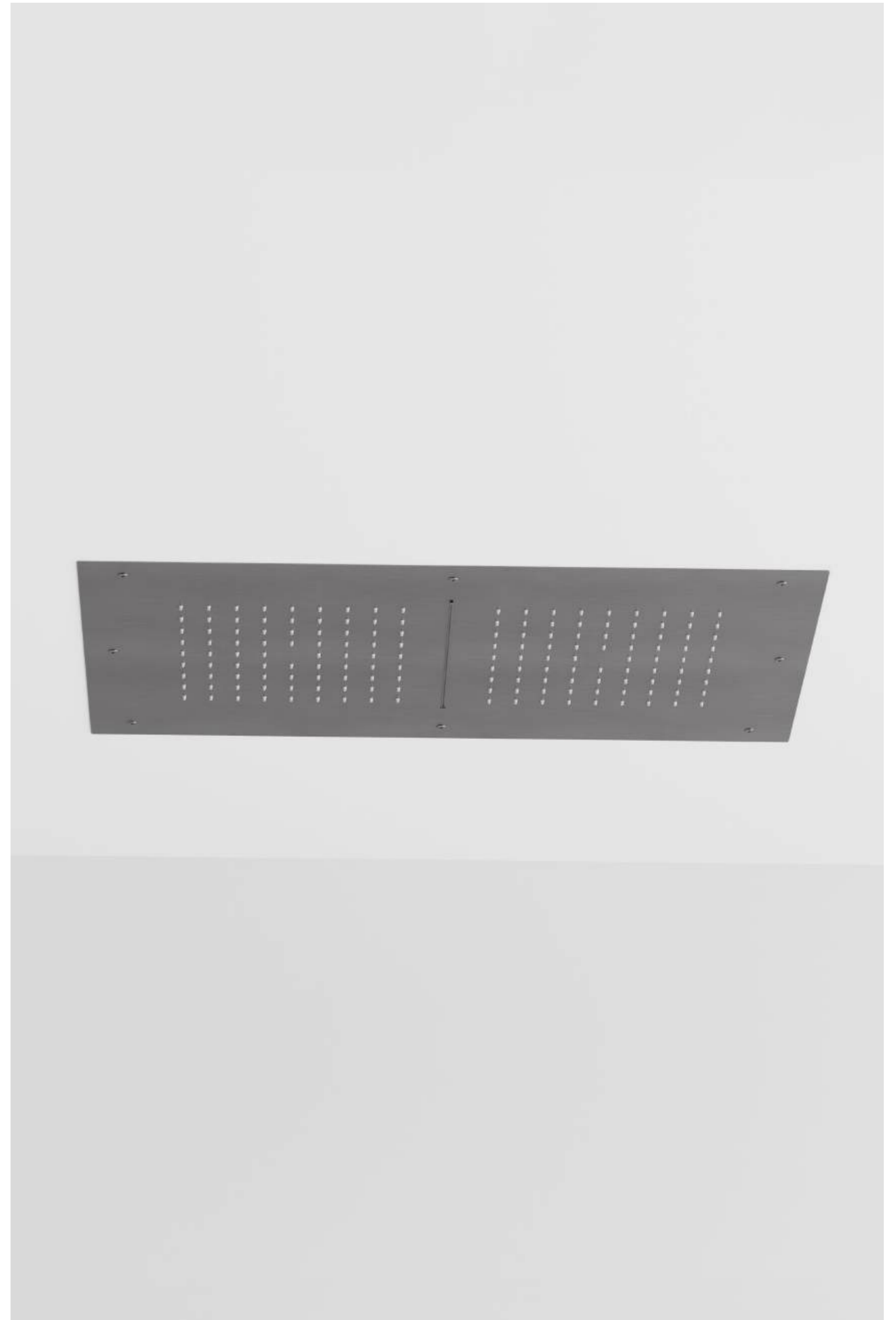
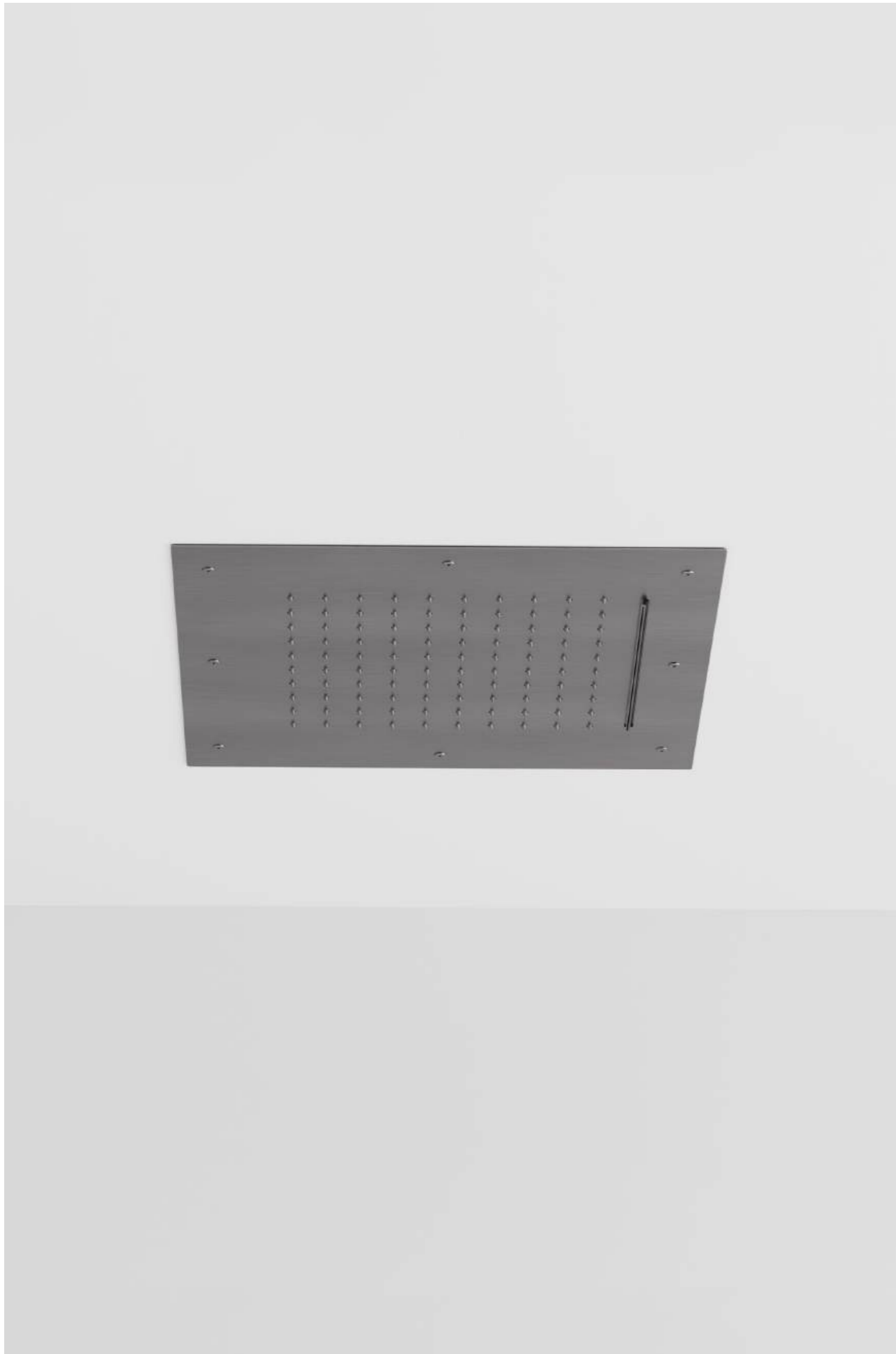



GLAM

Design by Giacomo Zucchi

Pure Forms, Timeless Elegance

"I focused on the use of pure shapes to create an empathetic and unique object, capable of generating tactile pleasure and a sense of harmony through its use."

Giacomo Zucchi





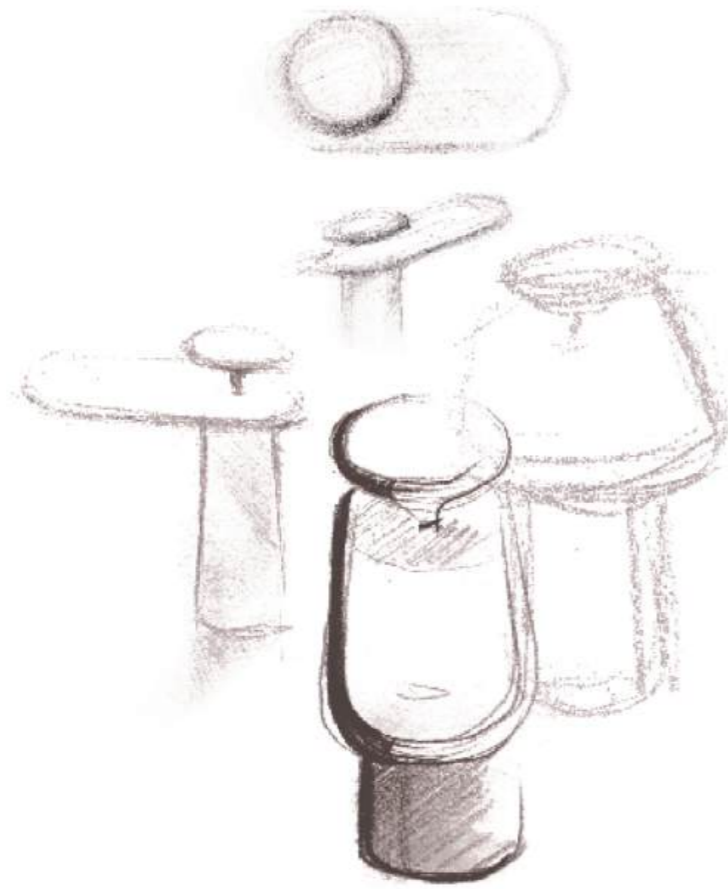

"I focused on the idea of simplicity and on the use of pure hape to create an empathic and unique object, capable to generatea tactic pleasure and a sense of harmony by it's use."



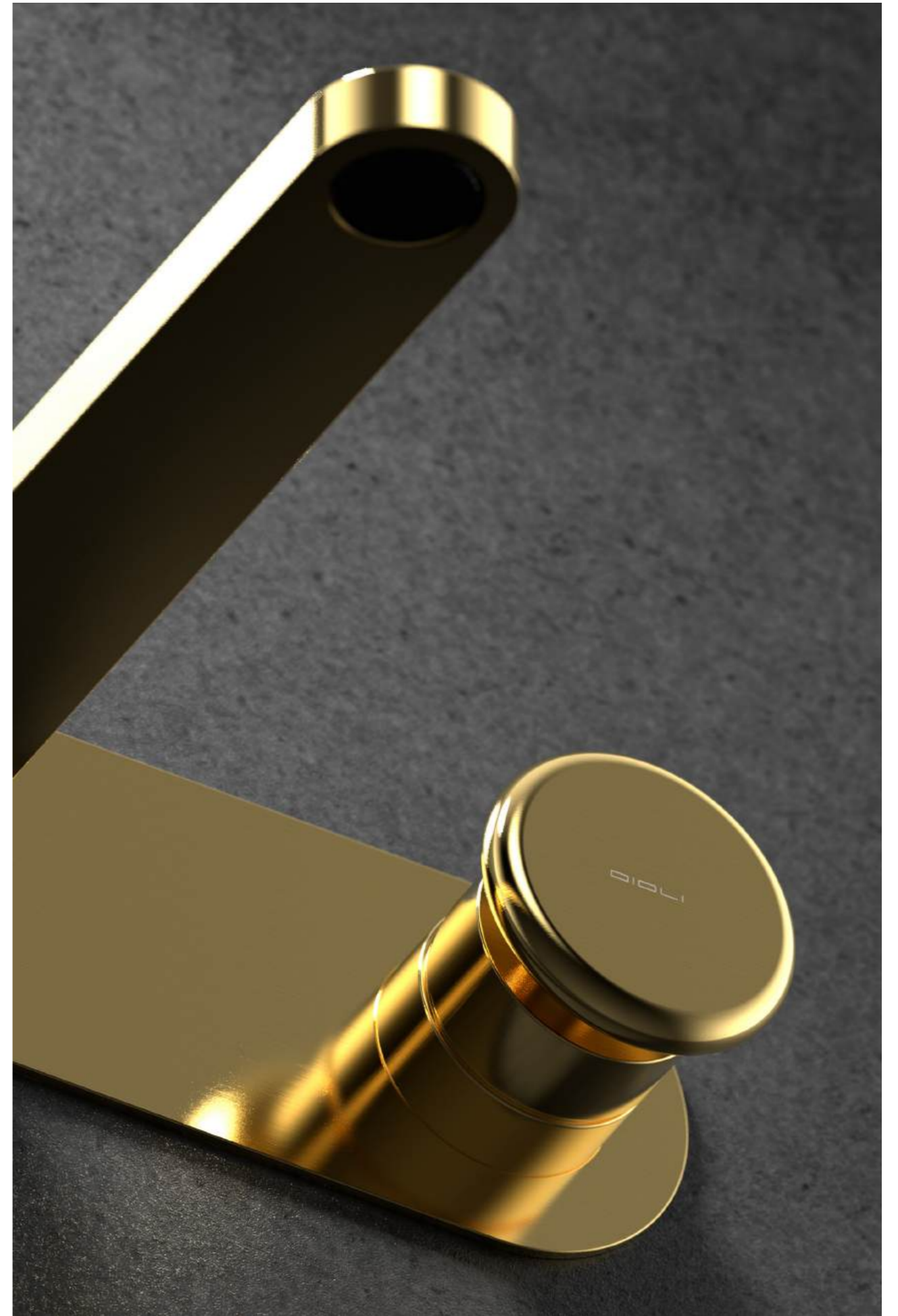



GLAM

"Pure simplicity. Pure harmony"

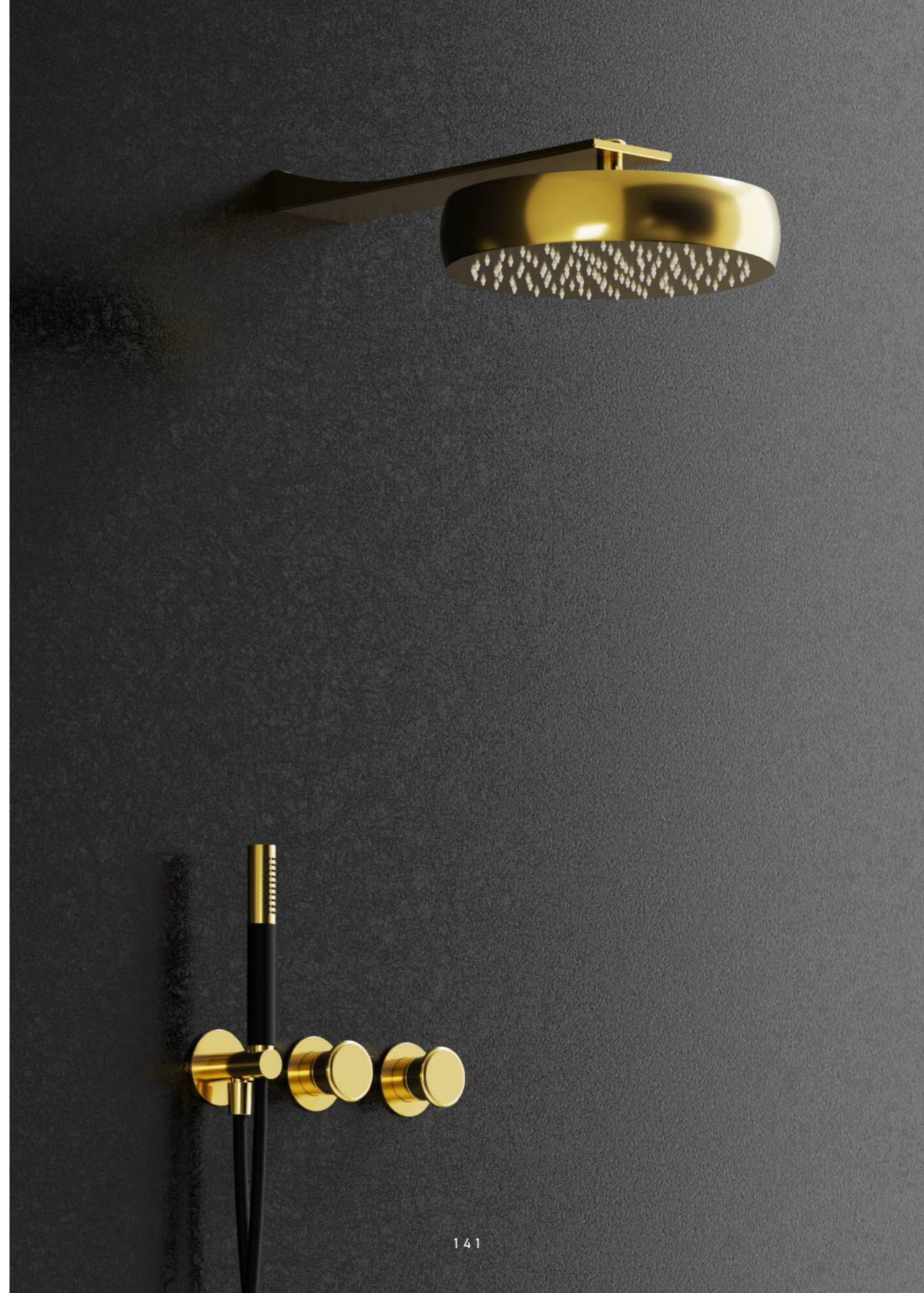

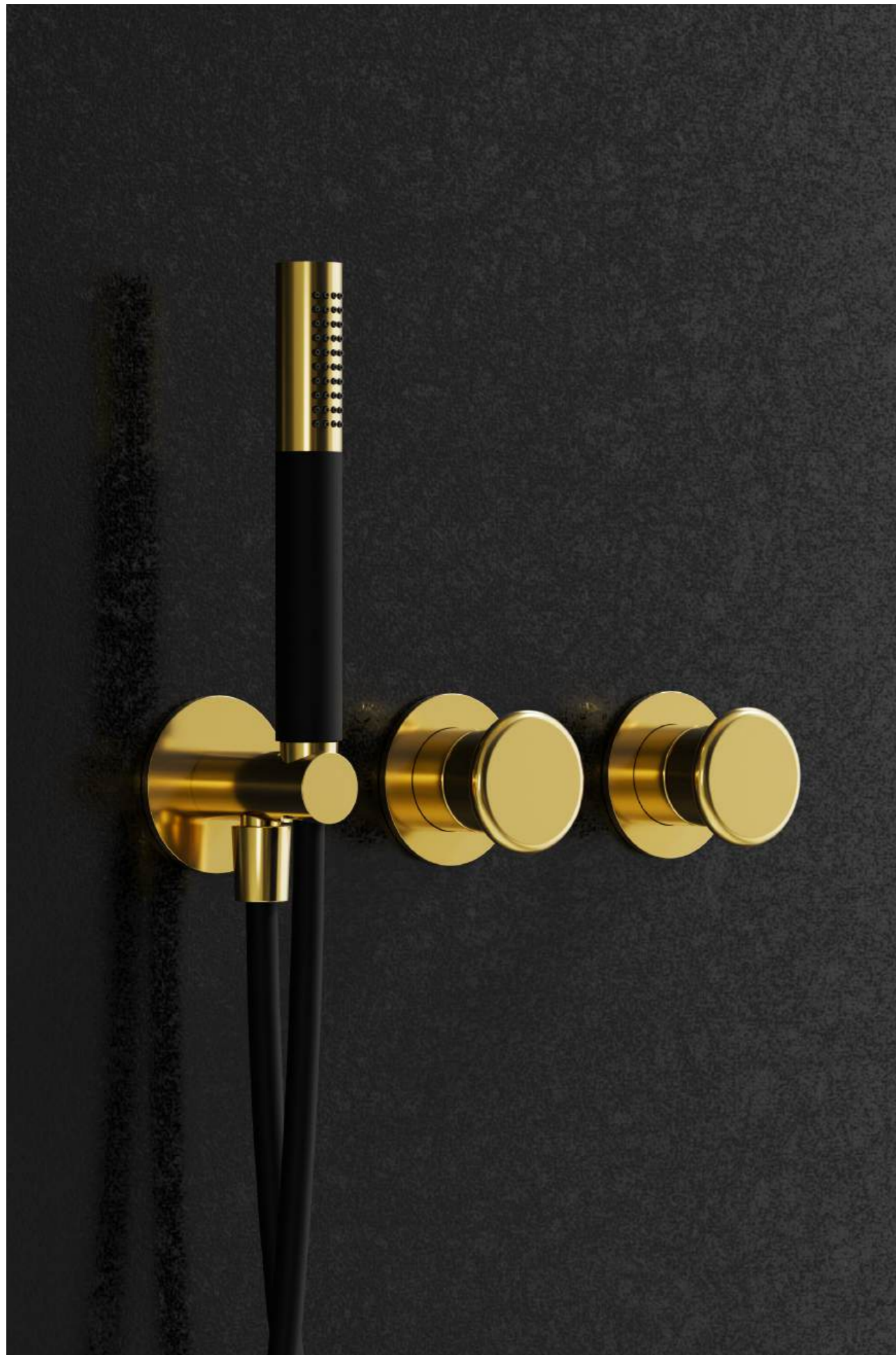

ZEN

Design by Giacomo Zucchi

Iconic design, essential beauty

*"I imagined a shape that expressed creativity in a rational way.
I tried to create a reassuring feeling between minimalism and elegance."*

Giacomo Zucchi



2019 PLATINUM WINNER
EUROPEAN
PRODUCT
DESIGN
AWARD





The three-hole basin faucet embodies **ZEN** collection philosophy: a perfect interplay of geometrie harmony and functional precision, where every element is designed to enhance both aesthetics and usability.



The pure lines of **ZEN** Collection evoke a unique and relaxing atmosphere, transforming the space into a sanctuary of well-being.



Z E N

"Where minimalism meets harmony."

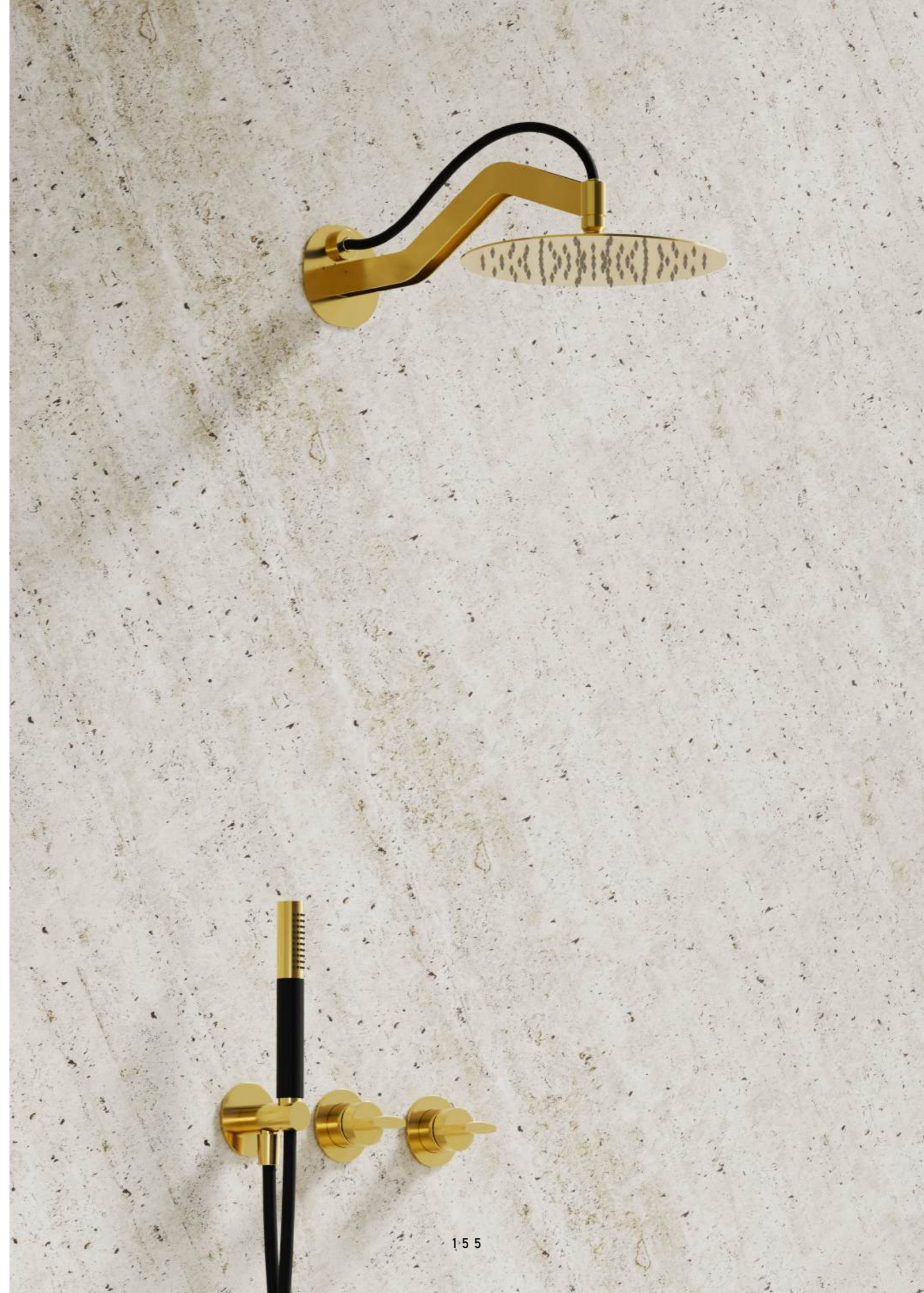

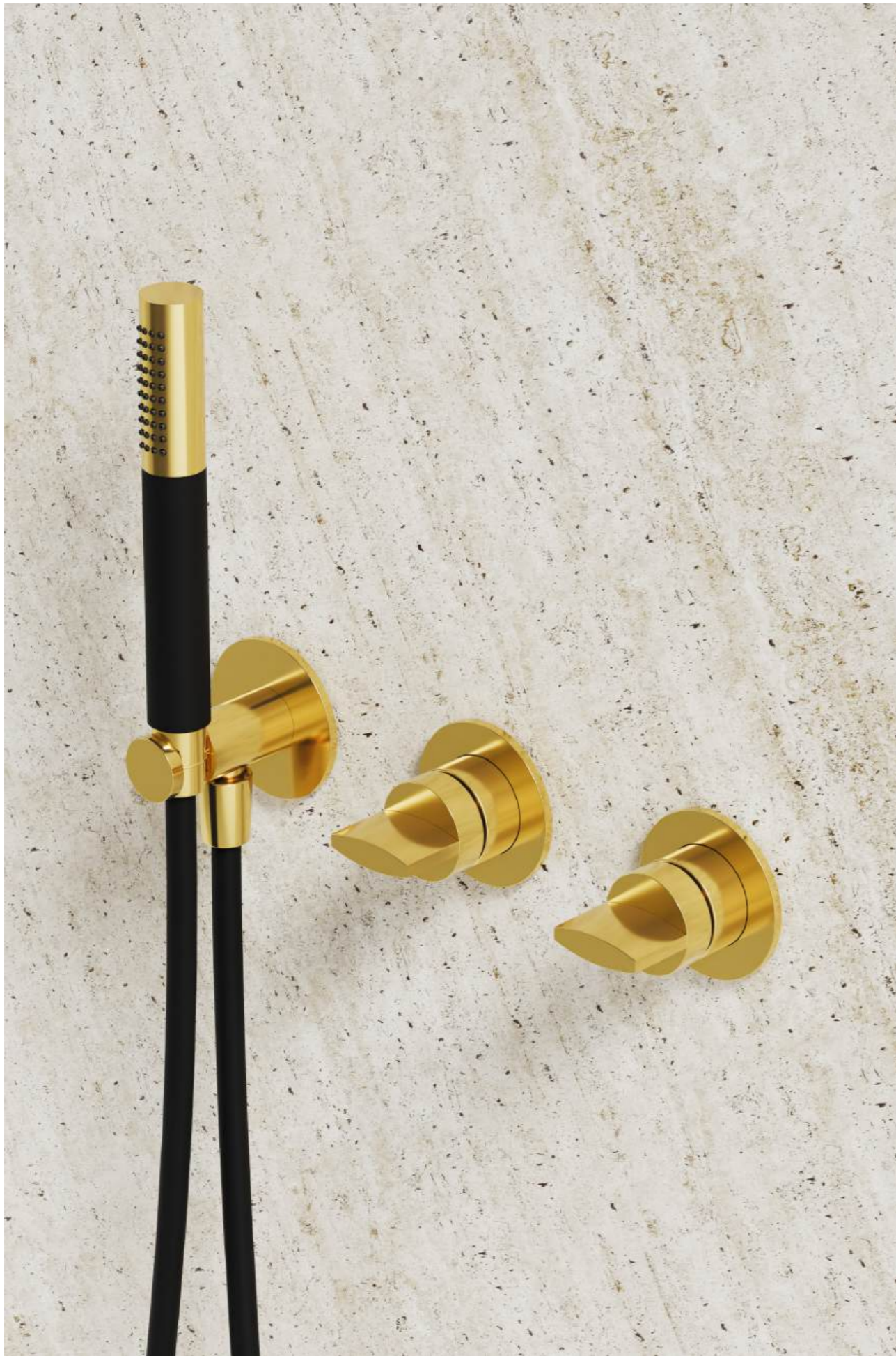

che BELLA

Bold character, refined minimalism, contemporary elegance

This faucet collection redefines the bathroom space with its essential lines and sculptural presence. Designed with meticulous attention to detail and finished in sophisticated matte tones, it combines durability, ergonomic comfort, and timeless style.

A harmonious fusion of form and function, created for interiors that celebrate personality, precision, and modern living.









T I K I

Pure geometry, contemporary expression

A perfect harmony of shapes and function. **TIKI** combines the fluidity of a cylindrical body with the precision of a rectangular lever and spout, creating a striking balance between elegance and practicality. Its bold yet refined design transforms everyday gestures into a seamless experience of style and comfort.



TIKI



168



169

TIKI



170



171

TIKI

"Minimalist yet distinctive,
it's expression of pure form."



TIKI



174

TIKI



175

TIKI

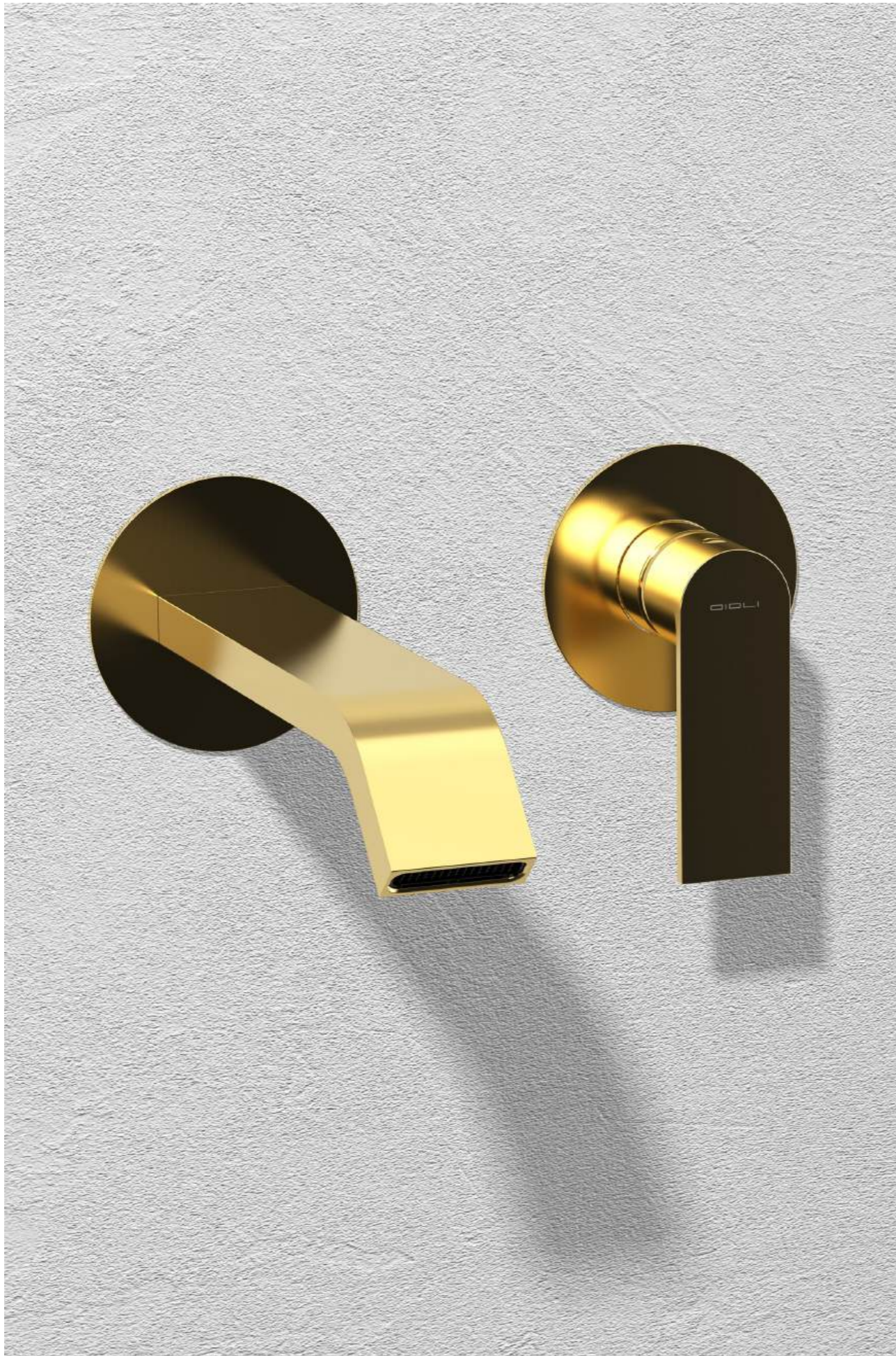

TIKI

"Where bold geometry
meets the art of everyday living."



TIKI



180



181

TIKI

“Shape your space, define your style.”



ZIMI

Pure lines, confident design

ZIMI is a faucet collection defined by clean geometry and contemporary elegance. Sharp lines and balanced proportions create a strong visual identity, while the ergonomic lever ensures smooth and precise control. A perfect expression of functionality and style, designed for those who appreciate clarity, precision, and timeless design.





ZIMI

"Where modern geometry
becomes pure elegance."



NOLI

The essence of italian elegance.

NOLI is a tribute to Italian heritage, inspired by the timeless proportions of classical architecture and the refinement of Italian style. Its handle features a dynamic design that seamlessly blends geometry with harmonious proportions, creating a perfect balance between tradition and modernity.



NOLI



192



193

N O L I

"Mediterranean light, perfectly rounded."





Soft curves enhance the collection's elegance, making it both contemporary and timeless. With Noli, every detail speaks of sophistication, craftsmanship, and the unmistakable beauty of Italian design.

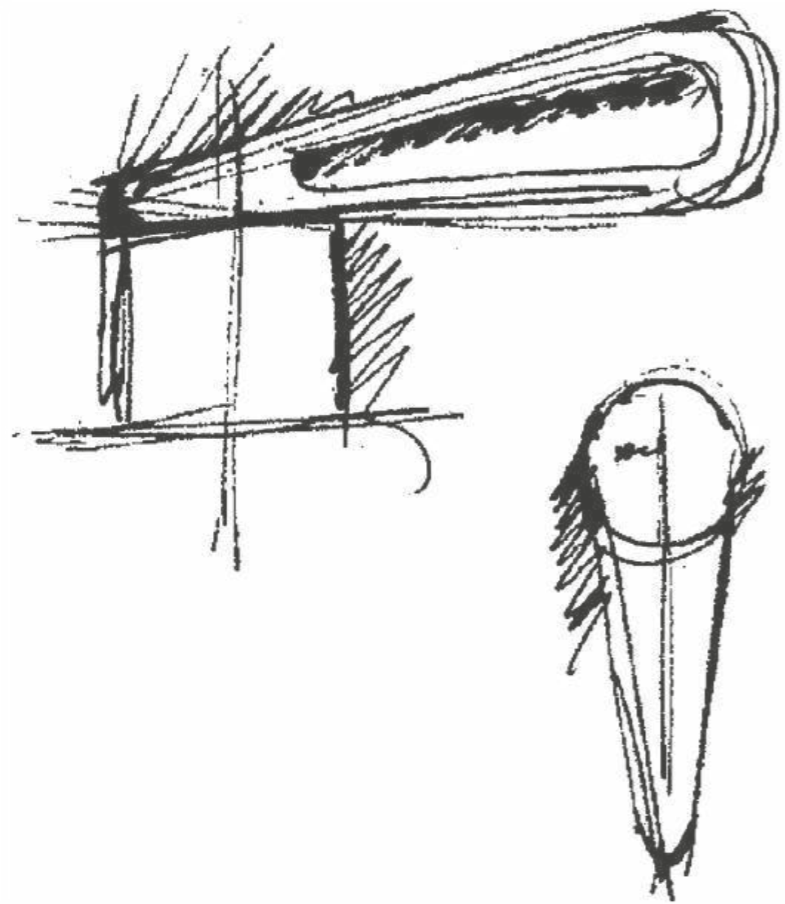

NOLI



200



201

MYLOS

The natural flow of wellness

Inspired by the untouched beauty of Milos, the Greek island of crystal-clear waters and sculpted cliffs, **MYLOS** collection brings the soothing essence of nature into any space. Its rectangular spout recreates the gentle, harmonious flow of a waterfall, transforming water into a source of relaxation and well-being.





M Y L O S

"Where lines and curves fall in love."





NYLOS

Soft volumes, refined character

NYLOS is a collection defined by essential shapes and harmonious proportions. The cylindrical body and gently contoured spout create a sense of visual balance, while the smooth control ensures a comfortable and intuitive user experience.





NYLOS

"Essential. Circular. Modern."





NYLOS

"Pure forms, pure function."

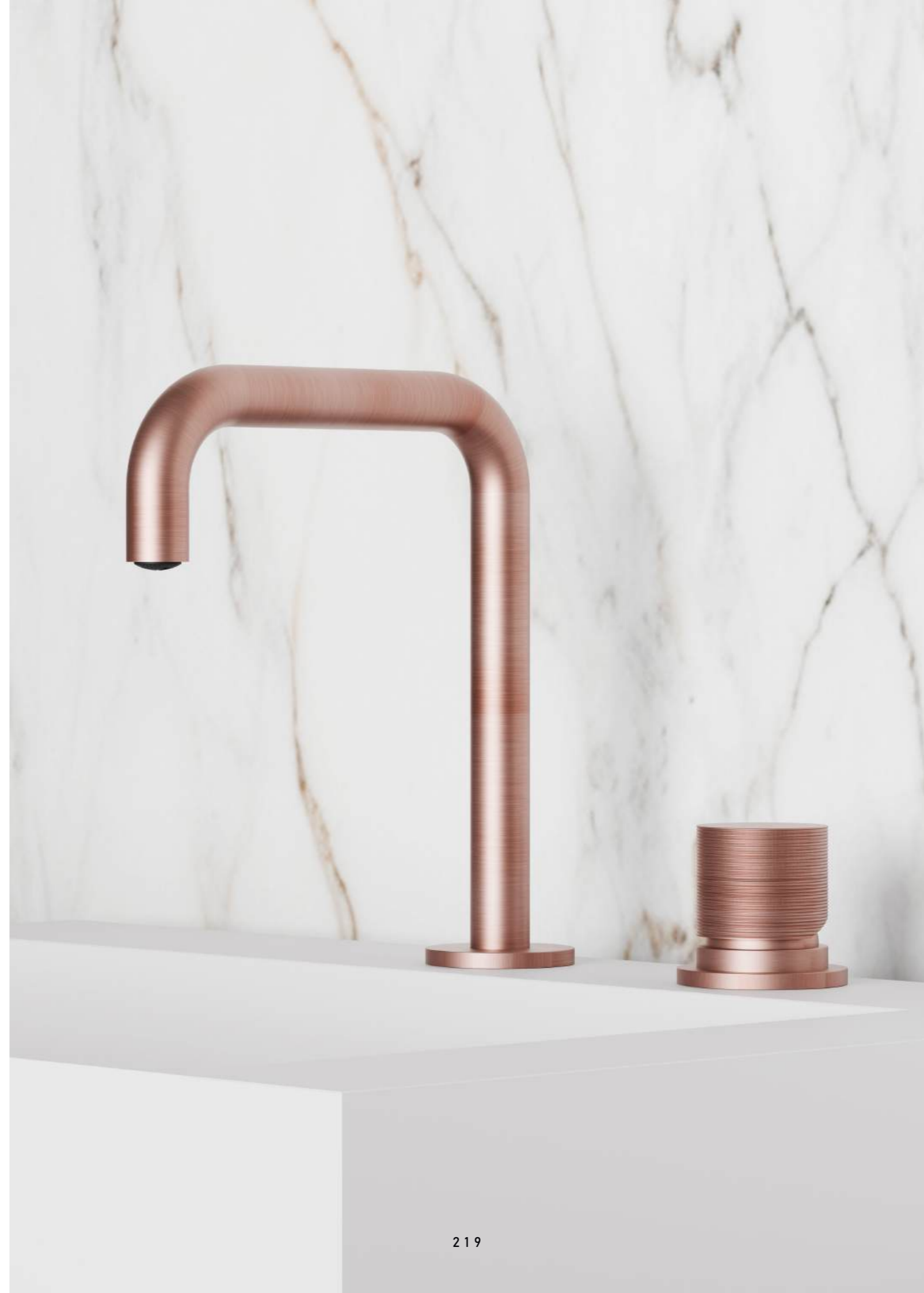



2 2 0

NYLOS

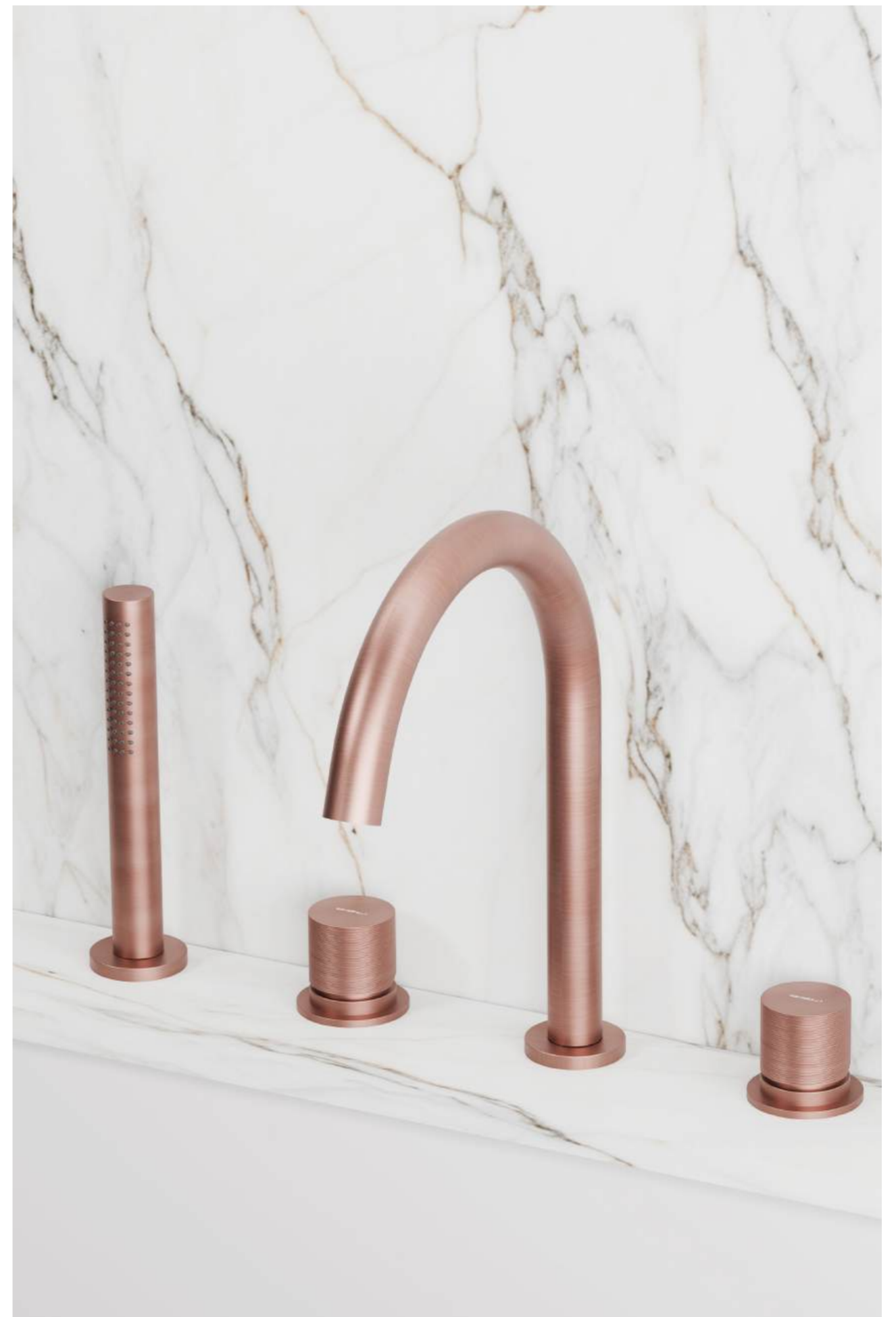

2 2 1

NYLOS



222

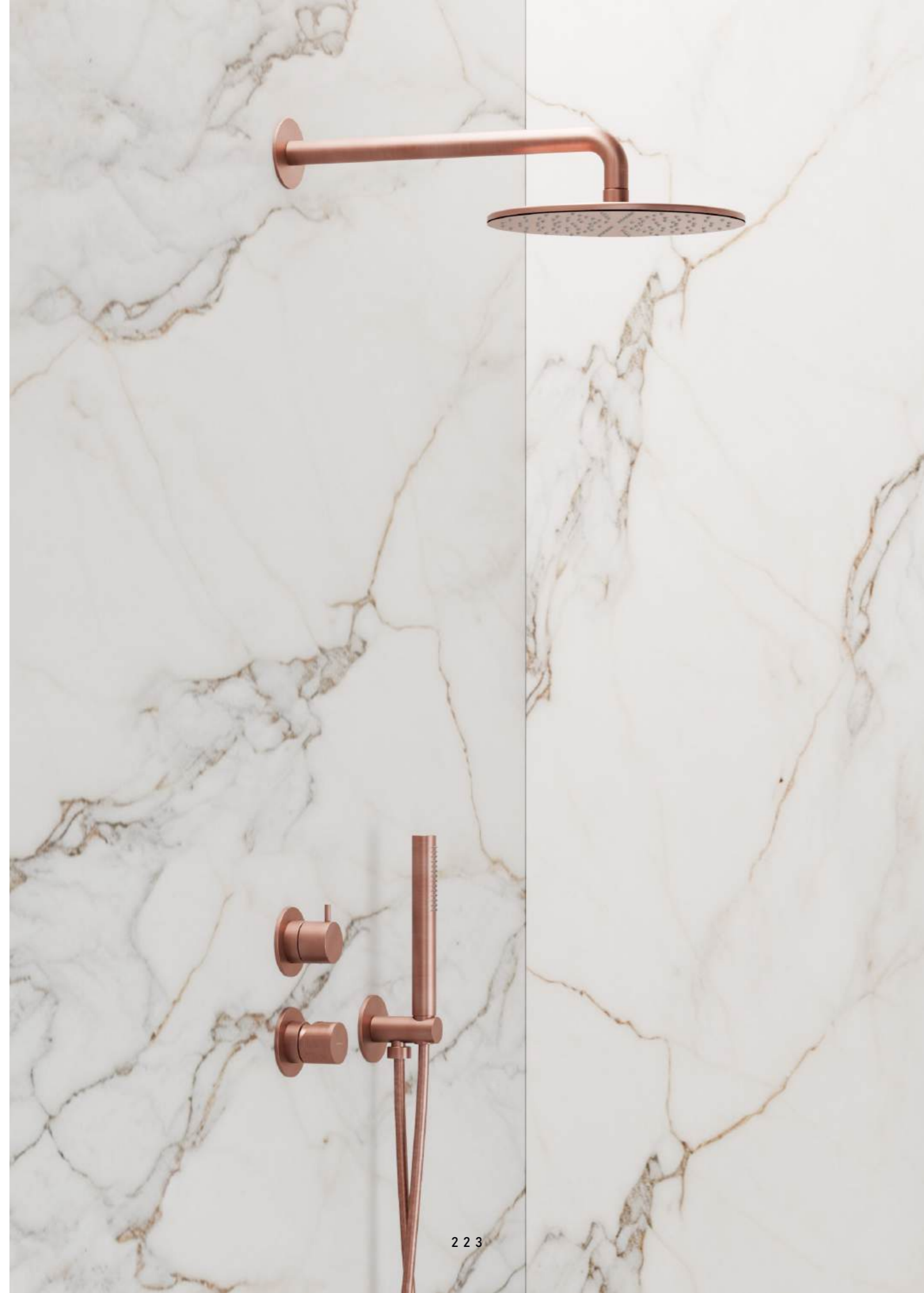

223

NAVONA

Elegance of classic style, dynamism of light

NAVONA series embodies timeless luxury and refined preciousness through precise spiral machining, sculpting the surface into a sophisticated play of facets.

A distinctive design that merges classic elegance with dynamic reflections, adding an exclusive touch to any space.

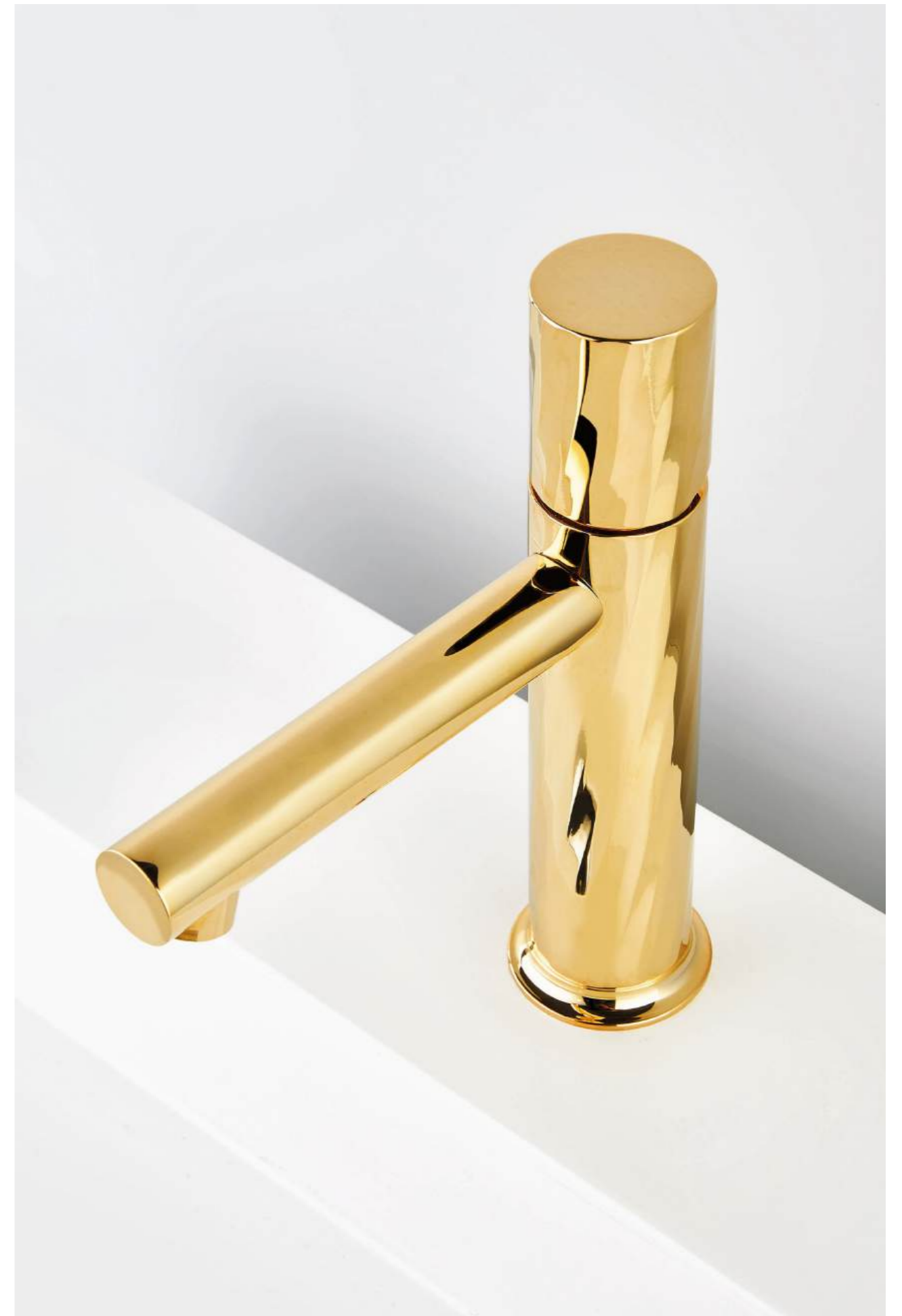







C O M O

Essential elegance, contemporary balance

Pure lines, confident character. **COMO** is born from a contemporary design vision, where minimalism and materiality meet in a harmonious, timeless form.

Clean geometries, carefully studied proportions, and refined details shape a collection that expresses both restraint and personality.





COMO



236

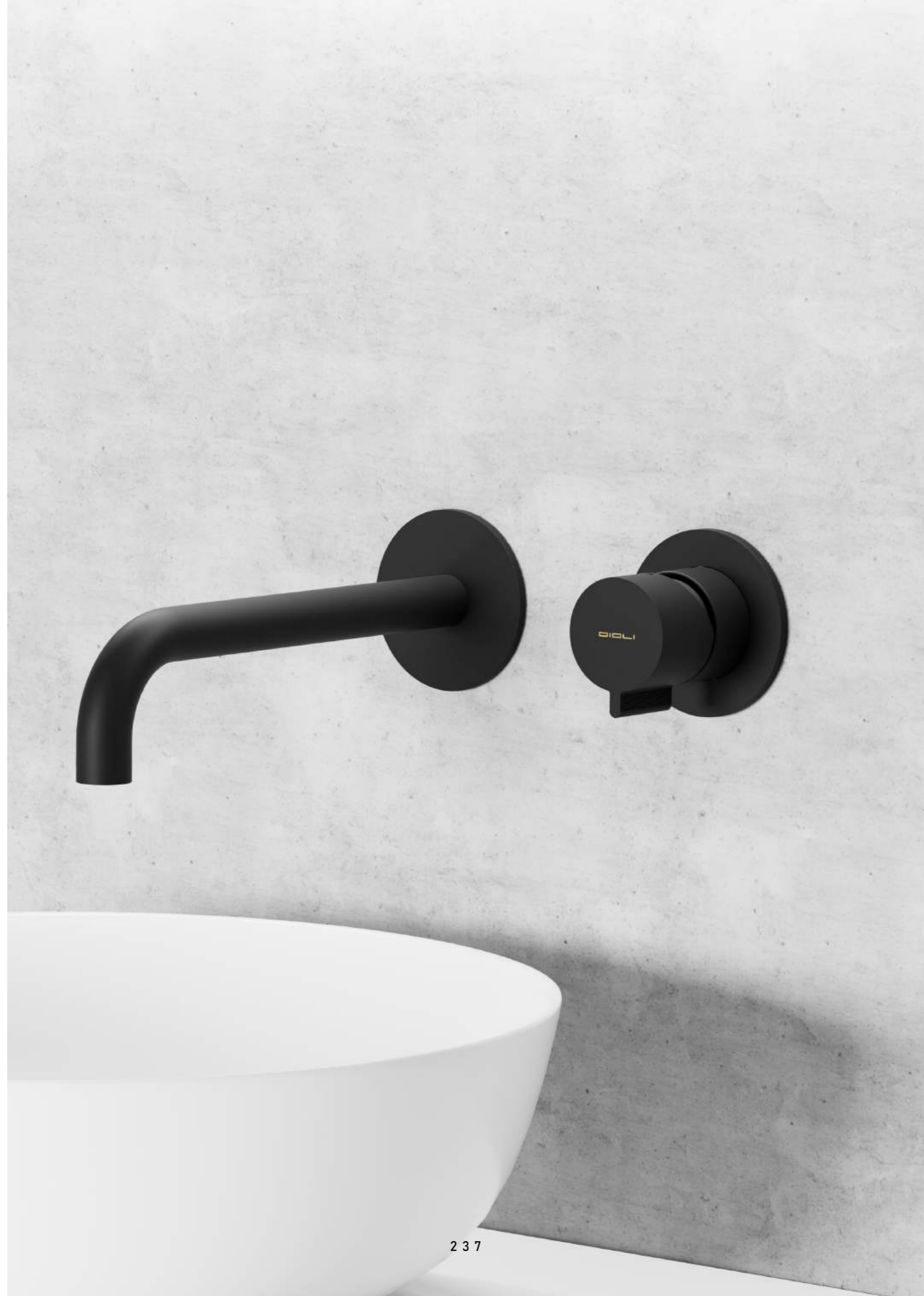

237

C O M O

"Where every curve tells a story,
and every flow becomes emotion."



COMO



240

COMO



241

COMO

"A circle of water, a ritual of beauty."



COMO



244

COMO

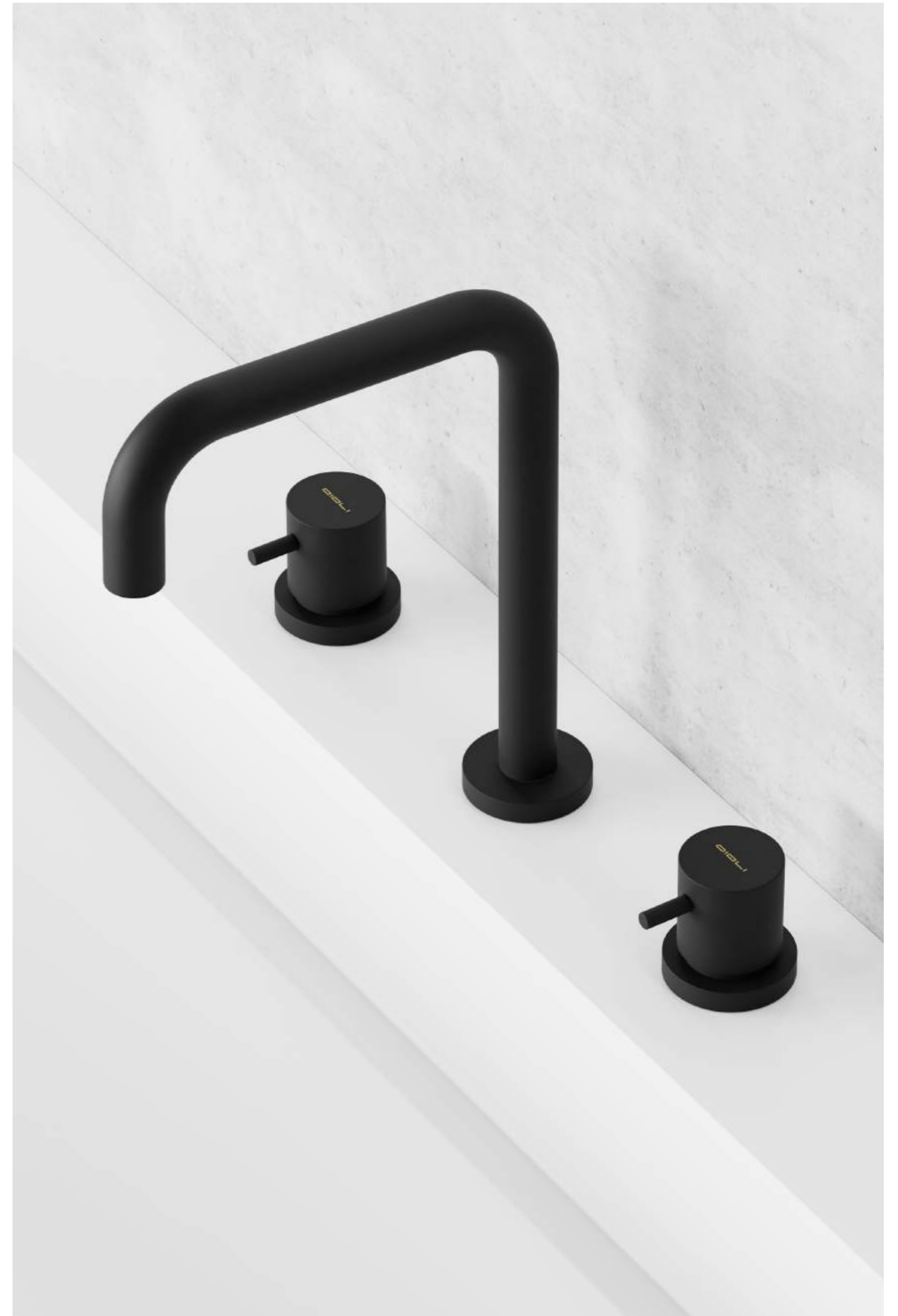

245

5th AVENUE

Industrial spirit, geometric harmony

Bold lines, urban attitude. **5TH AVENUE** draws inspiration from industrial design and geometric rigor, reinterpreting these elements with a modern and innovative vision.

Clean shapes, precise edges, and balanced proportions create a collection that is both striking and functional.

A fusion of strength and sophistication, 5TH AVENUE transforms industrial aesthetics into a bold expression of modern design.

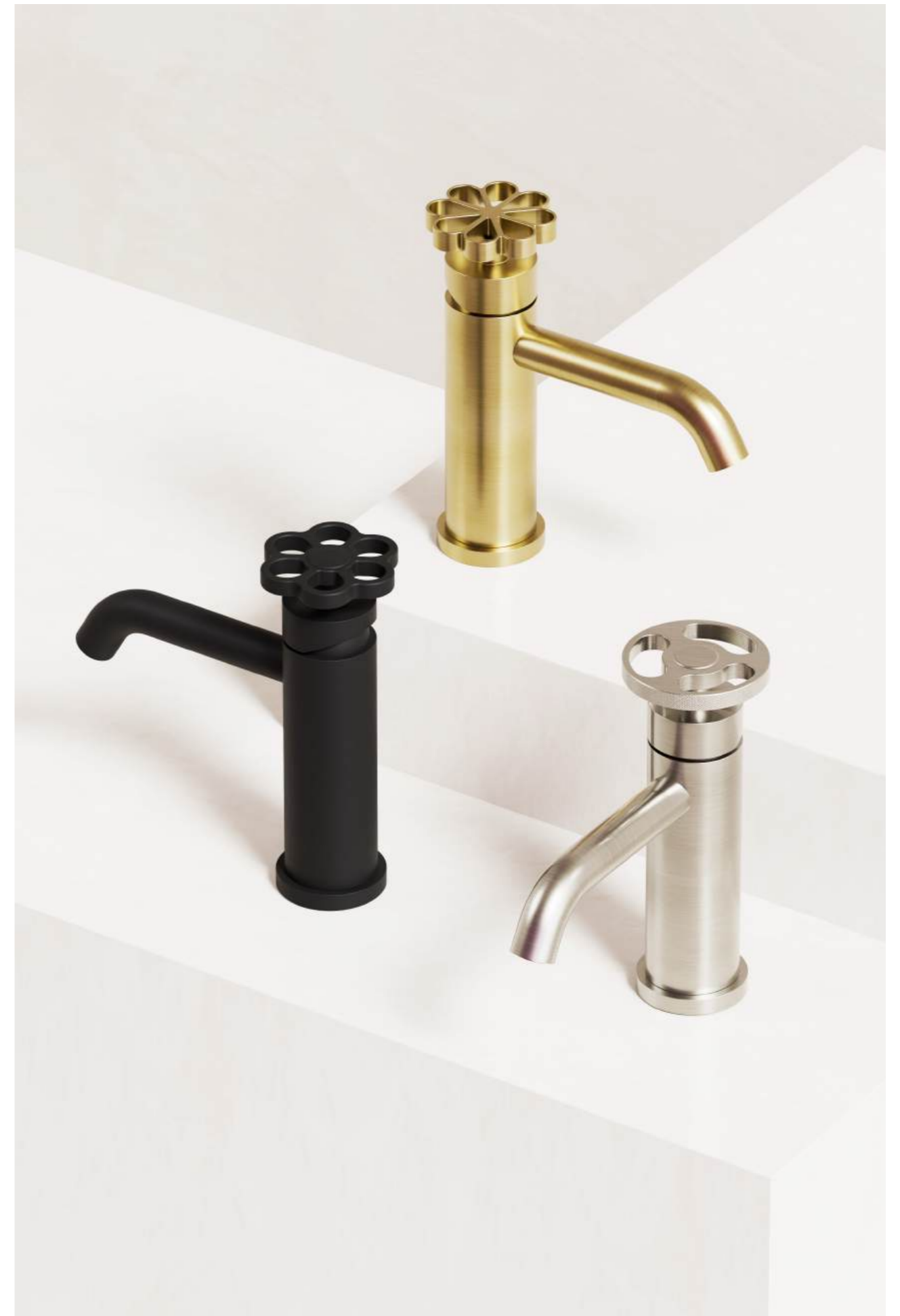

5th AVENUE

FLORENCE HANDLE

Inspired by the delicate strength of a blooming flower, Florence brings sculptural softness to the bathroom space. Its harmonious silhouette blends grace and precision, turning every gesture into a refined ritual. A tribute to organic beauty, interpreted through contemporary luxury.





5 t h A V E N U E

"Nobility of form, timeless by nature."

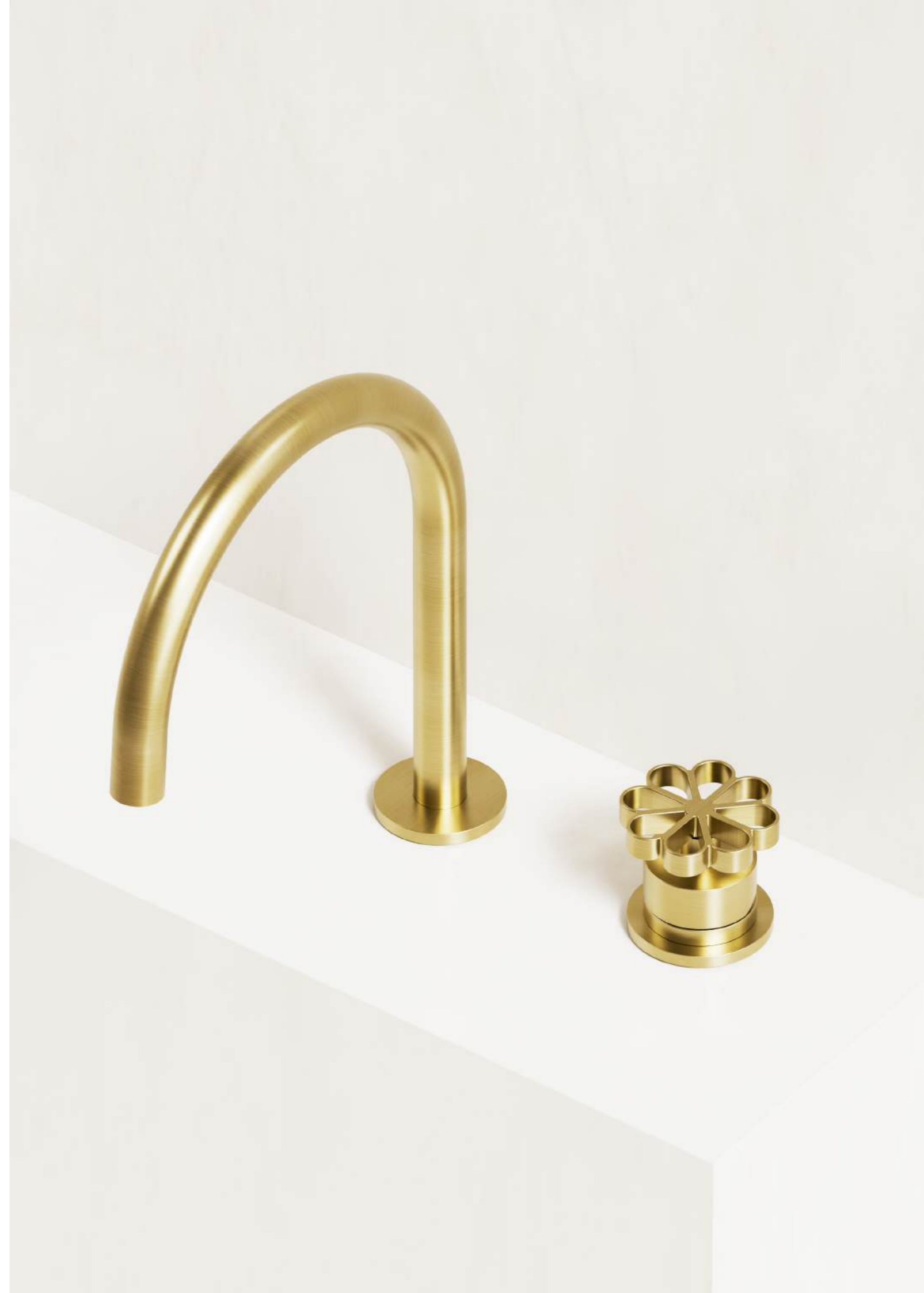



5 t h A V E N U E

"Downtown spirit, perfectly engineered."



5th AVENUE

SOHO HANDLE

Echoing the bold mechanics of 1960s hydrant levers, Soho channels industrial history into a sophisticated design language. Strong, tactile, and unmistakably urban, it embodies downtown attitude with uptown elegance.





5 t h A V E N U E

"Industrial edge. Urban precision."





5 t h A V E N U E

"Where industrial space meets refined design."





5th AVENUE

CLASSIC HANDLE

Perfectly round with finely knurled detailing, Classic celebrates traditional workmanship through a modern lens. Balanced proportions and textured precision create a tactile experience that speaks of enduring refinement.





5 t h A V E N U E

"Where the skyline meets the circle."





276



277

5 t h A V E N U E

"Where brick's industrial soul meets design brilliance."





280

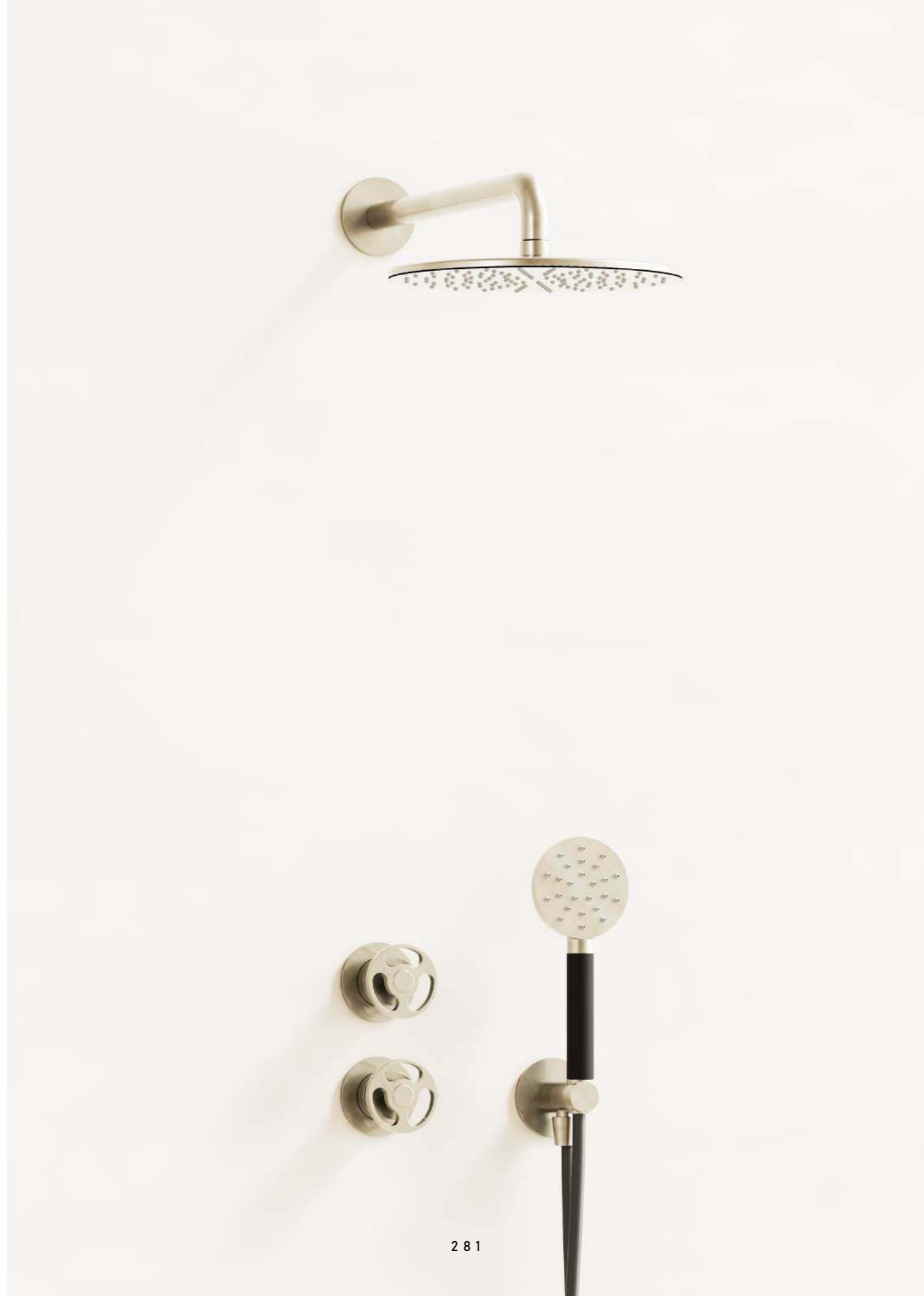

281

5th AVENUE

TUBE HANDLE

A seamless cylindrical form, reduced to its most essential expression. Tube embodies contemporary minimalism with effortless sophistication, a quiet luxury defined by perfect proportions and clarity of design.





5th AVENUE

VEGAS HANDLE

Industrial at heart, daring by nature. Vegas draws inspiration from raw architectural spaces and nocturnal city energy. Its bold presence transforms minimal interiors into statements of character and confidence.





PURA

Design that inspires.

PURA revolutionizes the concept of the faucet with an innovative spout and handle, featuring arching details that evoke creativity and playfulness.

A dynamic, elegant, and surprising design, capable of transforming every gesture into an experience of style and originality.

A touch of innovation, every day.



PURA



292



293

PURA

"Architectural purity in motion."



PURA



296



297

M I C R O

Timeless Elegance, Perfect Harmony

Classic yet versatile, **MICRO** embodies a design that seamlessly integrates into any bathroom. With its refined lines and enduring style, it enhances spaces with a perfect balance of functionality and timeless beauty. A collection where elegance meets practicality, designed to last.



MICRO



3 0 0

MICRO



3 0 1

M I C R O

"Pure round. Timeless presence."



MICRO



304

MICRO



305

M I C R O

"Designed to flow through time."



MICRO



308

MICRO



309

M I C R O

"Minimal shape. Maximum character."



MICRO



MICRO



312



313

M I C R O

"The curve that defines modern."



MICRO



316

MICRO



317

M I C R O

"Aged iron depth. green serenity. orange energy."



MICRO



3 2 0



3 2 1

M I C R O

"Color. Curve. Continuity."





MICRO



3 2 6



3 2 7

MICRO



328



329

M I C R O

"Timeless form, distinctive shades."

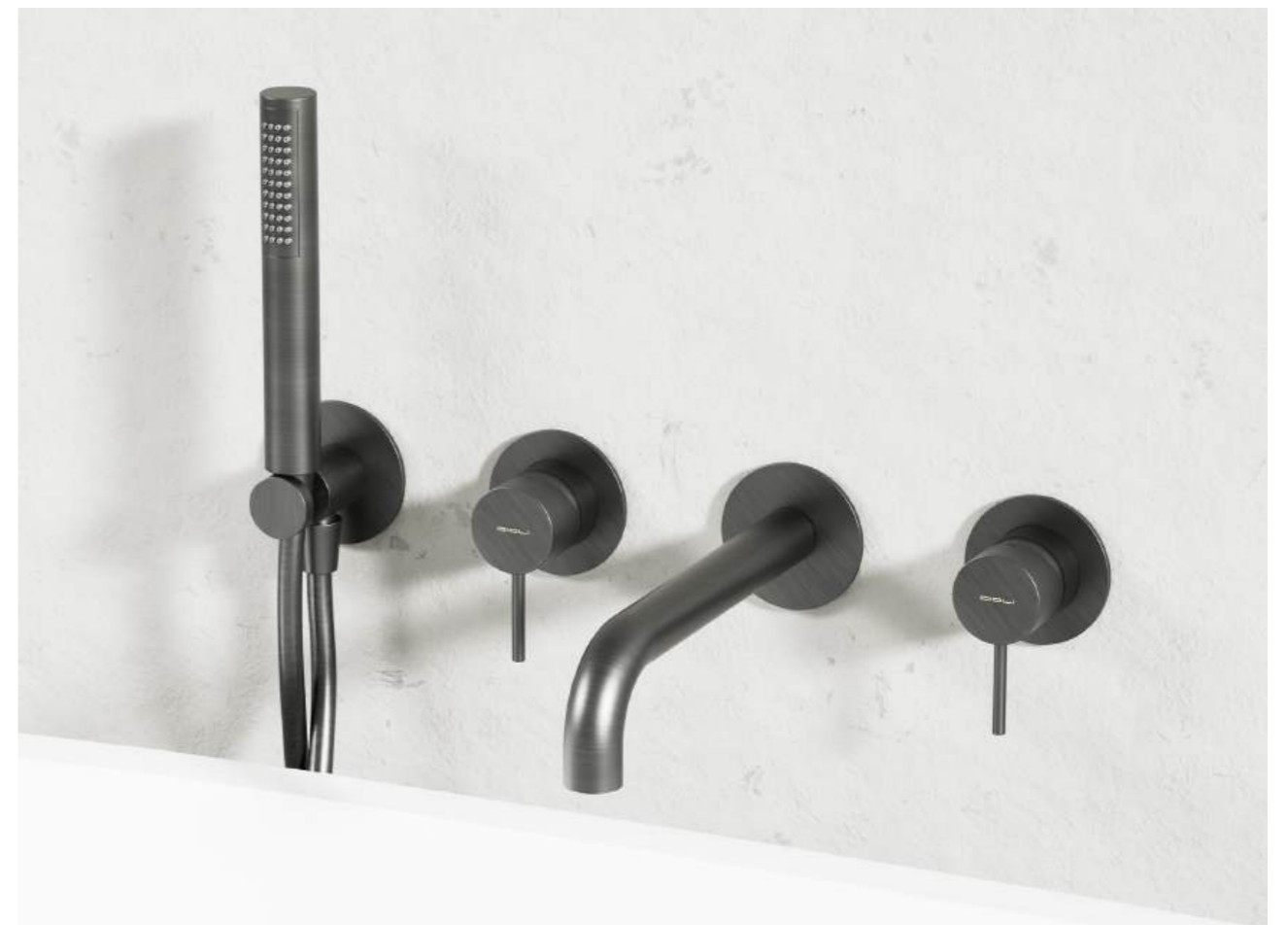

MICRO

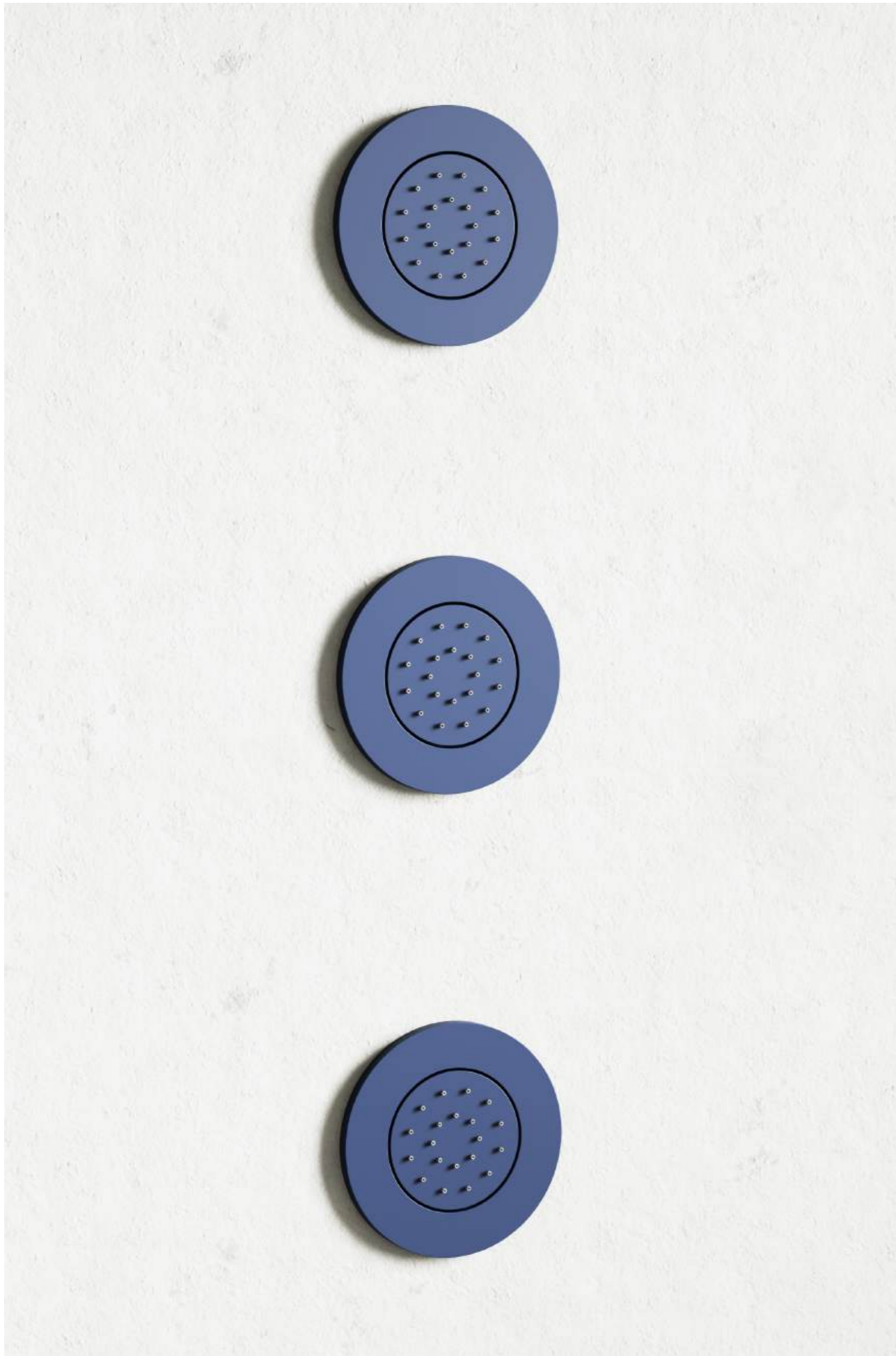

332

MICRO

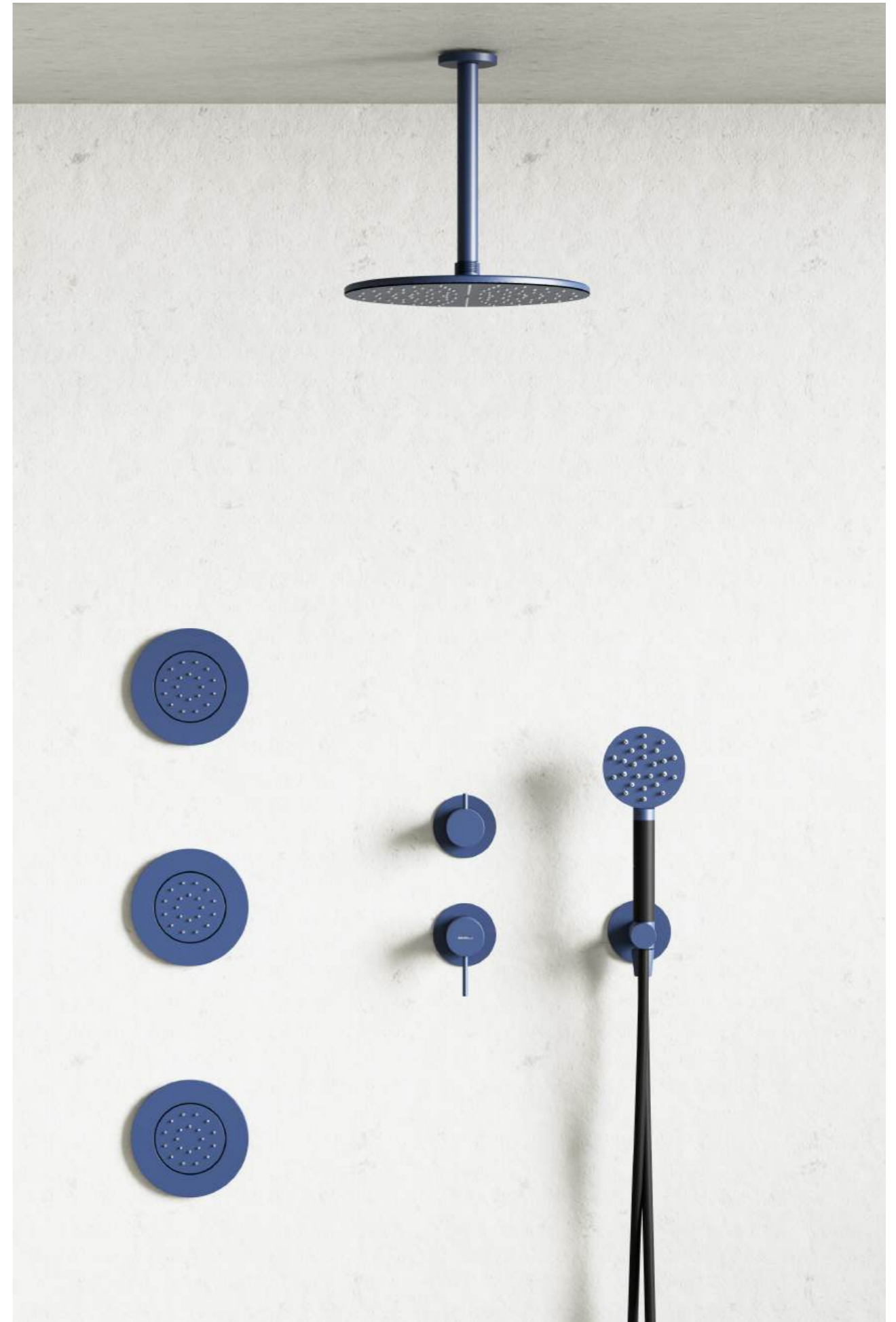

333



MICRO



336

MICRO



337

M I C R O

"Timeless by design. Distinctive by nature."



KREO

The Art of Design in Every Drop

KREO is the faucet collection that redefines bathroom aesthetics with a dynamic, innovative, and refined design.

Fluid lines, exquisite details and a touch of originality come together to create unique solutions where elegance and functionality blend in perfect harmony.

With Kreò, every space gains character and personality, transforming water into a style experience.





K R E O

"Where minimalism rises."







K R E O



3 5 0



3 5 1

K R E O

"Silence in form. Emotion in motion."





K R E O

"Where white becomes presence."





STILO

The lever as an iconic gesture

STILO is a collection where the lever defines the character of the design. Its distinctive cross-shaped handle becomes a sculptural element, immediately recognizable and perfectly balanced atop the cylindrical body. The essential spout and solid proportions enhance the strength of the lever's geometry, creating a refined contrast between form and function.







STILO

"Unique handle featuring four softly rounded tips, blending essential design with a subtle, iconic detail."



STILO

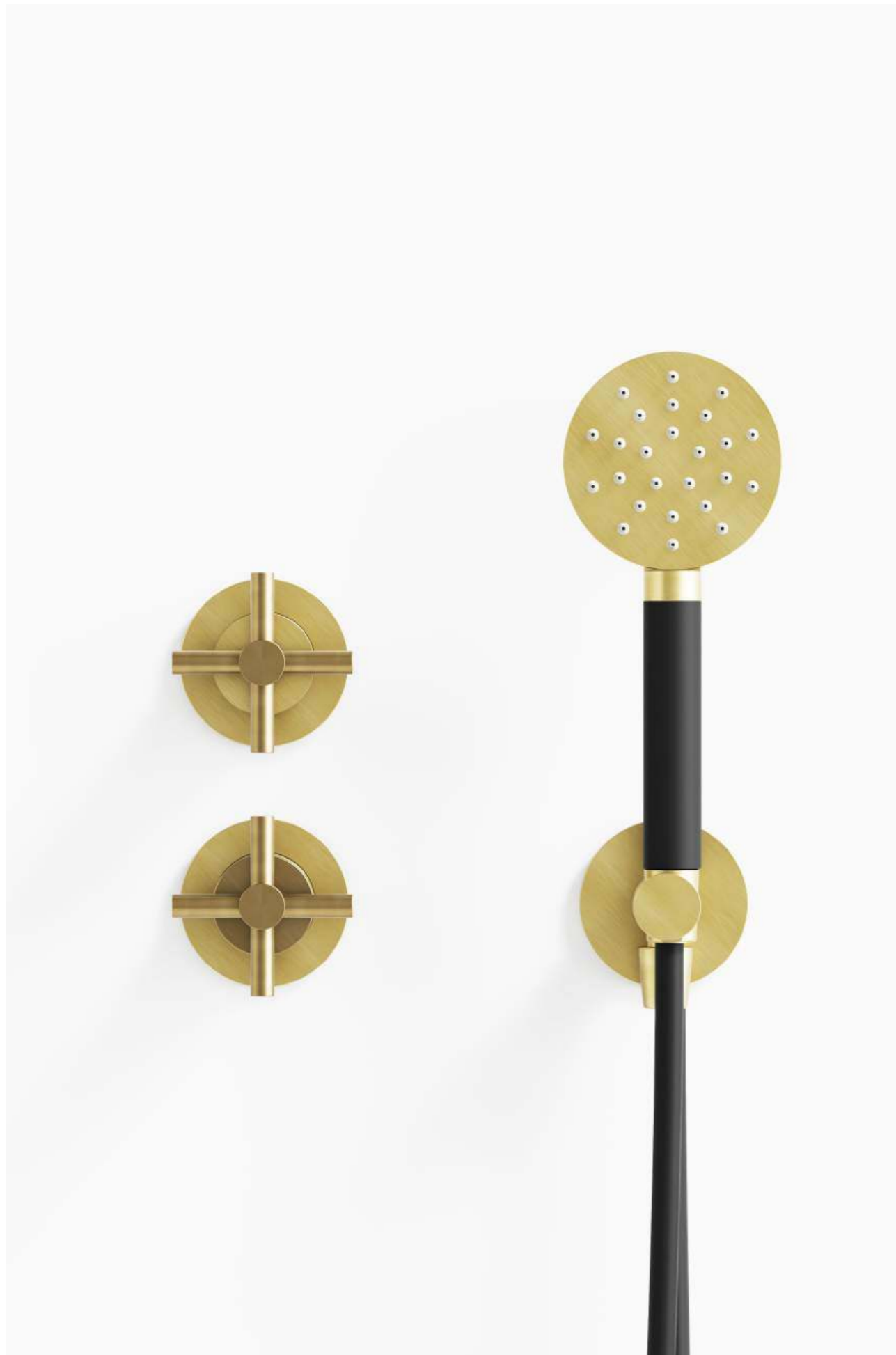

368

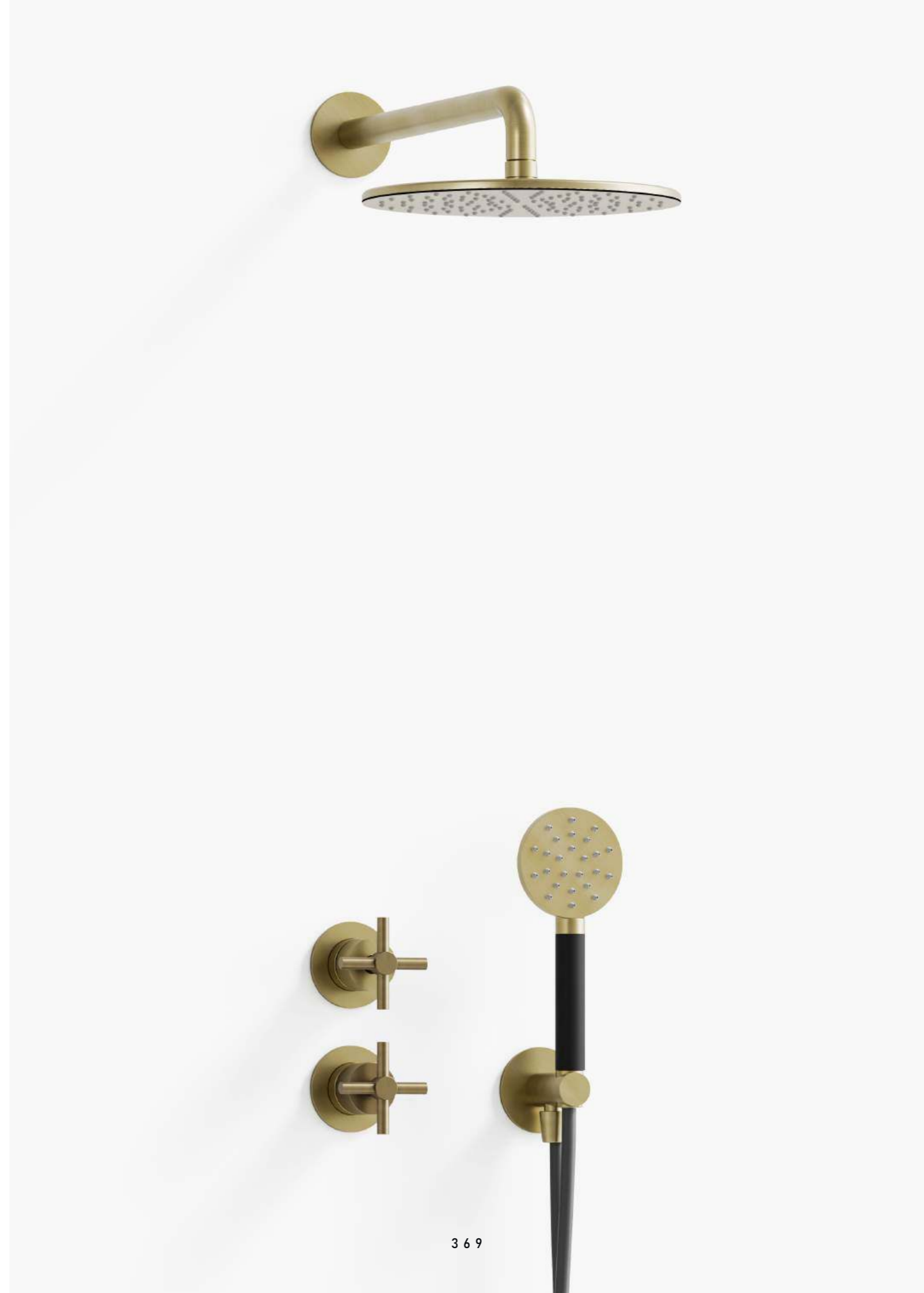

369

MIRAME

MIRAME is an invitation to experience water in its most graceful expression. Defined by its perfectly round silhouette, the collection transforms a simple daily gesture into a moment of visual and sensory harmony.

Its distinctive waterfall flow creates a soft, continuous cascade pure, fluid, captivating. The movement of water becomes part of the design itself, enhancing the atmosphere of the bathroom with lightness and balance.







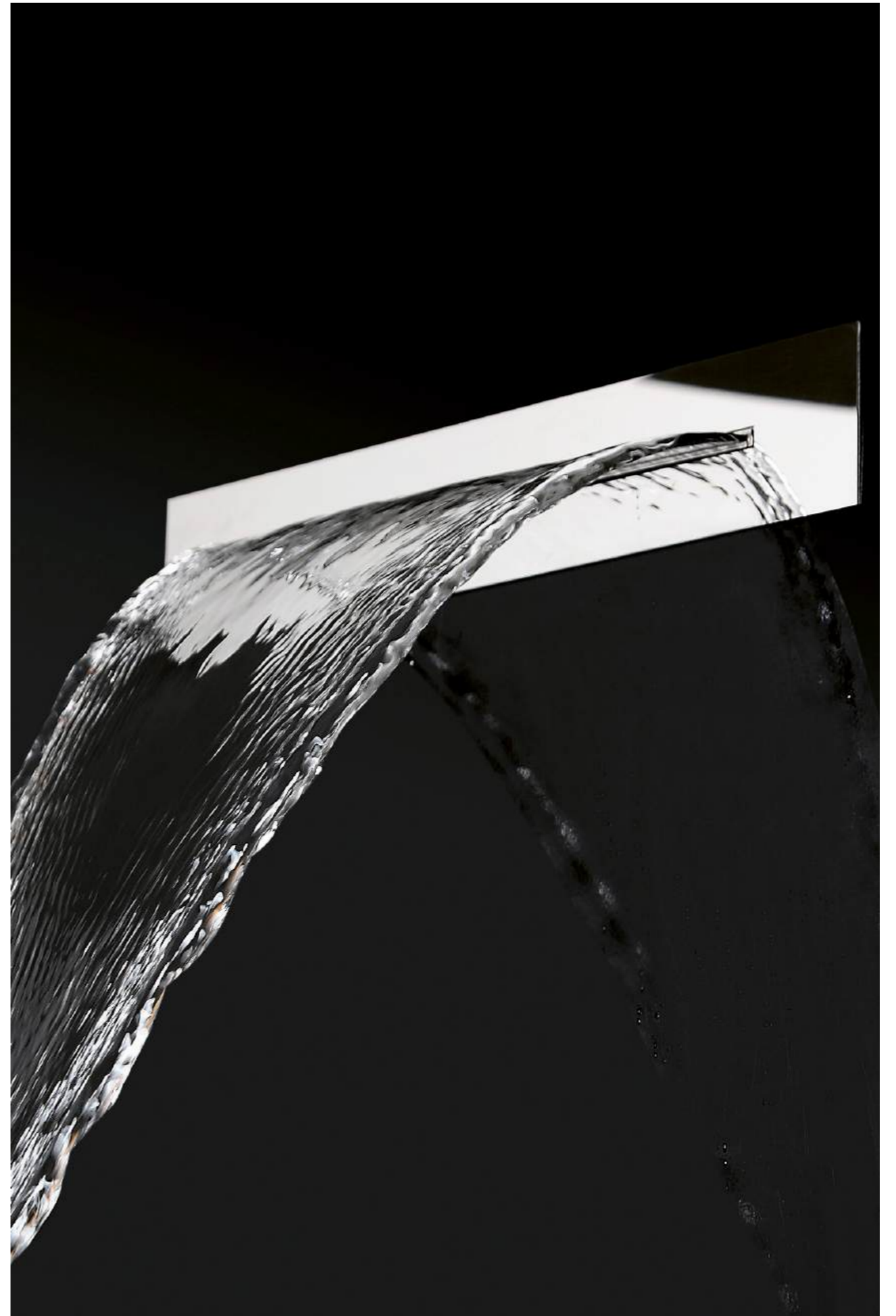

JAZZ

Harmony in form. Balance in design.

JAZZ is defined by its perfectly round silhouette and gently softened edges, creating a sense of visual comfort and effortless elegance. Its smooth contours allow it to blend naturally into any bathroom setting, from contemporary interiors to more classic environments.

Designed for versatility, JAZZ adapts with ease – never overpowering the space, yet always adding character. Like its musical inspiration, it is fluid, balanced and timeless.



JAZZ



380



381





384

JAZZ



385

SPRITZ

Linear clarity, essential balance

SPRITZ is a collection defined by precision and lightness, where clean geometry shapes a contemporary presence.

The linear, rectangular spout reinforces the sense of control and proportion, while the contrast between flat surfaces and softened volumes gives the design a quiet, timeless elegance. Spritz is the expression of formal restraint combined with everyday functionality.







SPRITZ



392

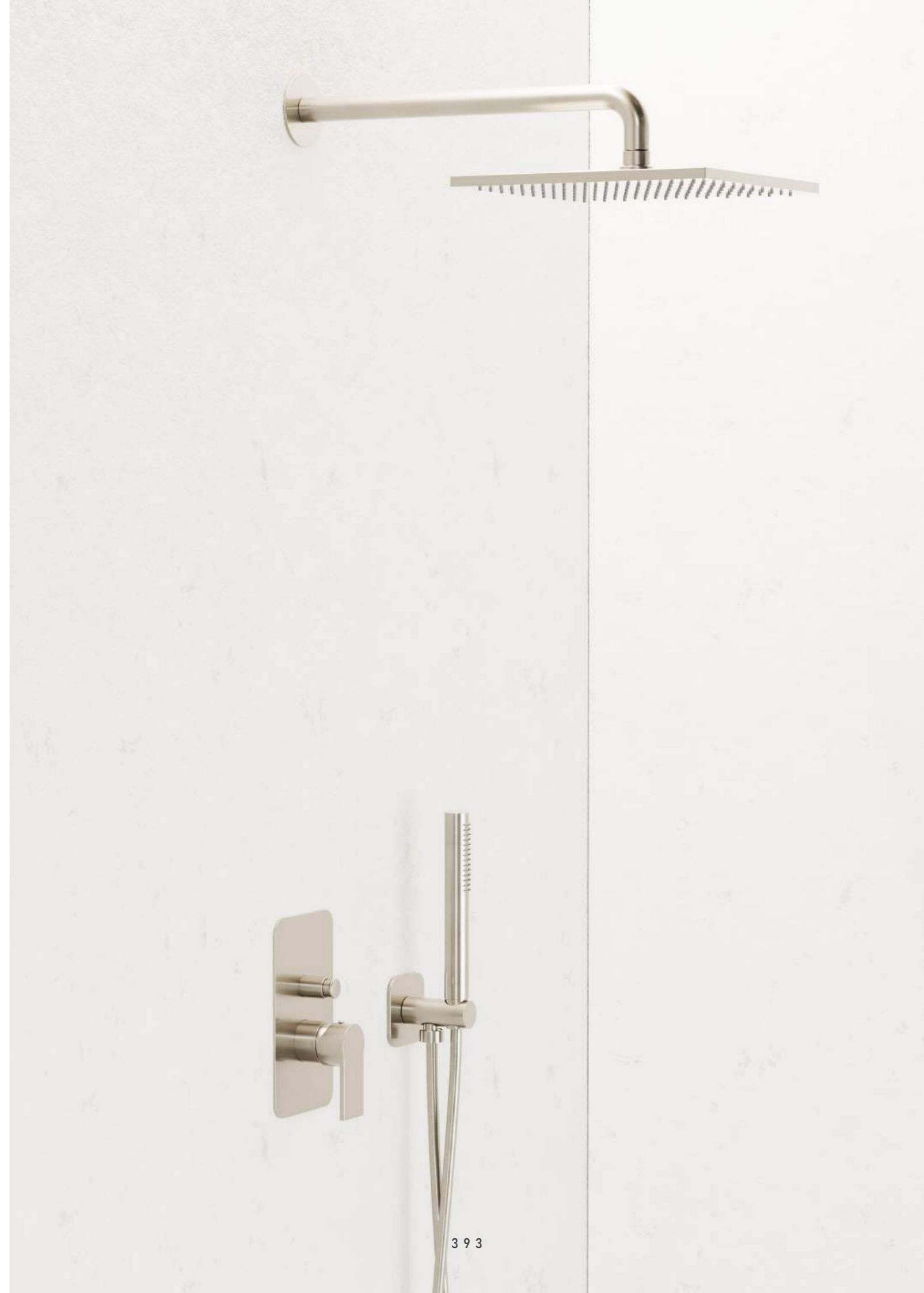

393

KING

The authority of linear design

KING is a collection defined by sharp geometries and architectural precision. Its slender body and flat, squared spout create a silhouette of modern strength and essential elegance.

The minimalist lever seamlessly aligns with the spout's profile, emphasizing a clean, continuous flow. King balances bold proportions with refined details, making it a definitive statement for the contemporary bathroom.



KING



396



397



VIDA

Designed to bring balance into everyday life, **VIDA** expresses simplicity in its most harmonious form. Its perfectly round body is paired with a clean, linear lever a seamless dialogue of soft curves and precise lines.

The collection stands out for its refined matte finishes, enhancing its understated elegance and transforming the bathroom into a space of quiet comfort. Calm, tactile surfaces and essential geometry create an atmosphere of daily well-being.





V I D A

"Where simplicity becomes serenity."





MIAMI

Pure geometry. Urban spirit.

Defined by its perfectly round form, **MIAMI** blends effortlessly into minimalist and contemporary spaces. Essential in design, versatile in application, it brings balance, clarity and modern character to every bathroom environment.

Contemporary simplicity, elevated.





M I A M I

"Minimal form. Metropolitan spirit."







OPÉRA

OPERA embodies the grandeur of classical design, reinterpreted through refined, contemporary lines. Created for the most elegant interiors, it brings timeless harmony and noble presence to the bathroom space.

Its exclusive gold finish enhances its sculptural character, adding a touch of distinction that makes the collection truly unique.

An expression of enduring elegance.





OPÉRA

"Nobility of form, timeless by nature."





LONDON

Timeless heritage

LONDON captures the essence of classic sophistication through a refined vintage aesthetic. Its high arched spout and dual lever handles, finished with elegant white ceramic details, evoke a sense of traditional luxury. London is a tribute to timeless craftsmanship, blending historical charm with the reliability of modern engineering.

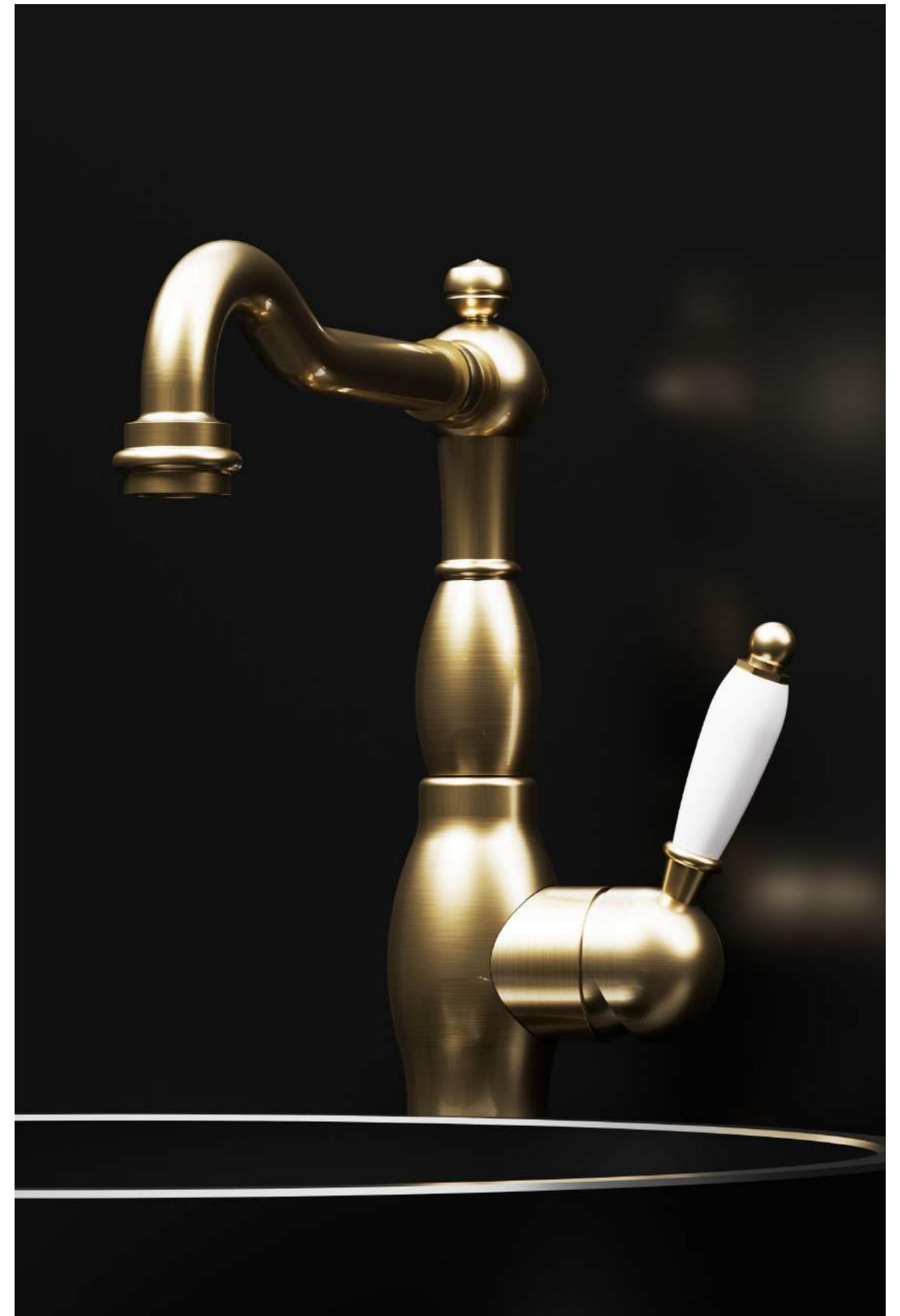

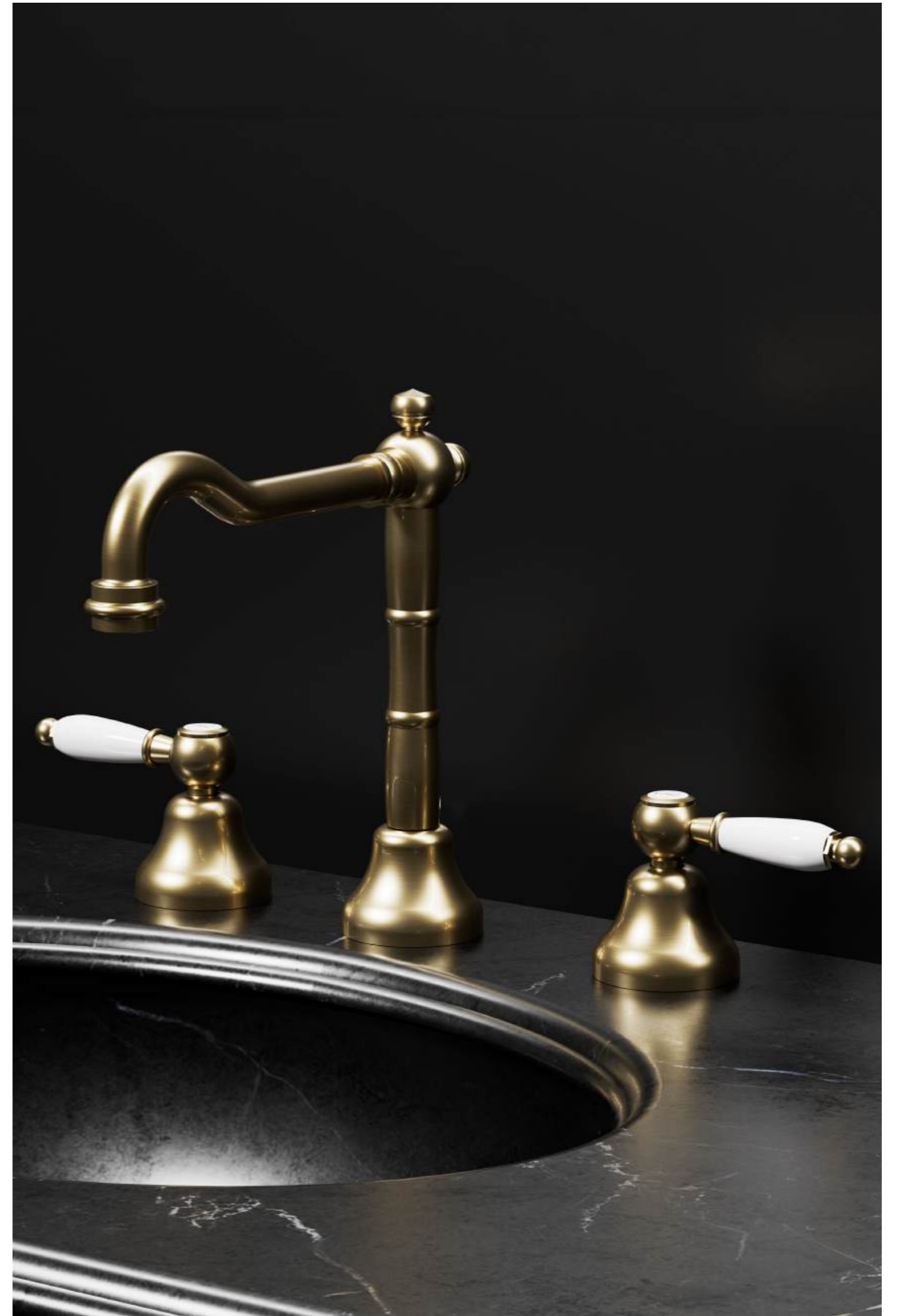

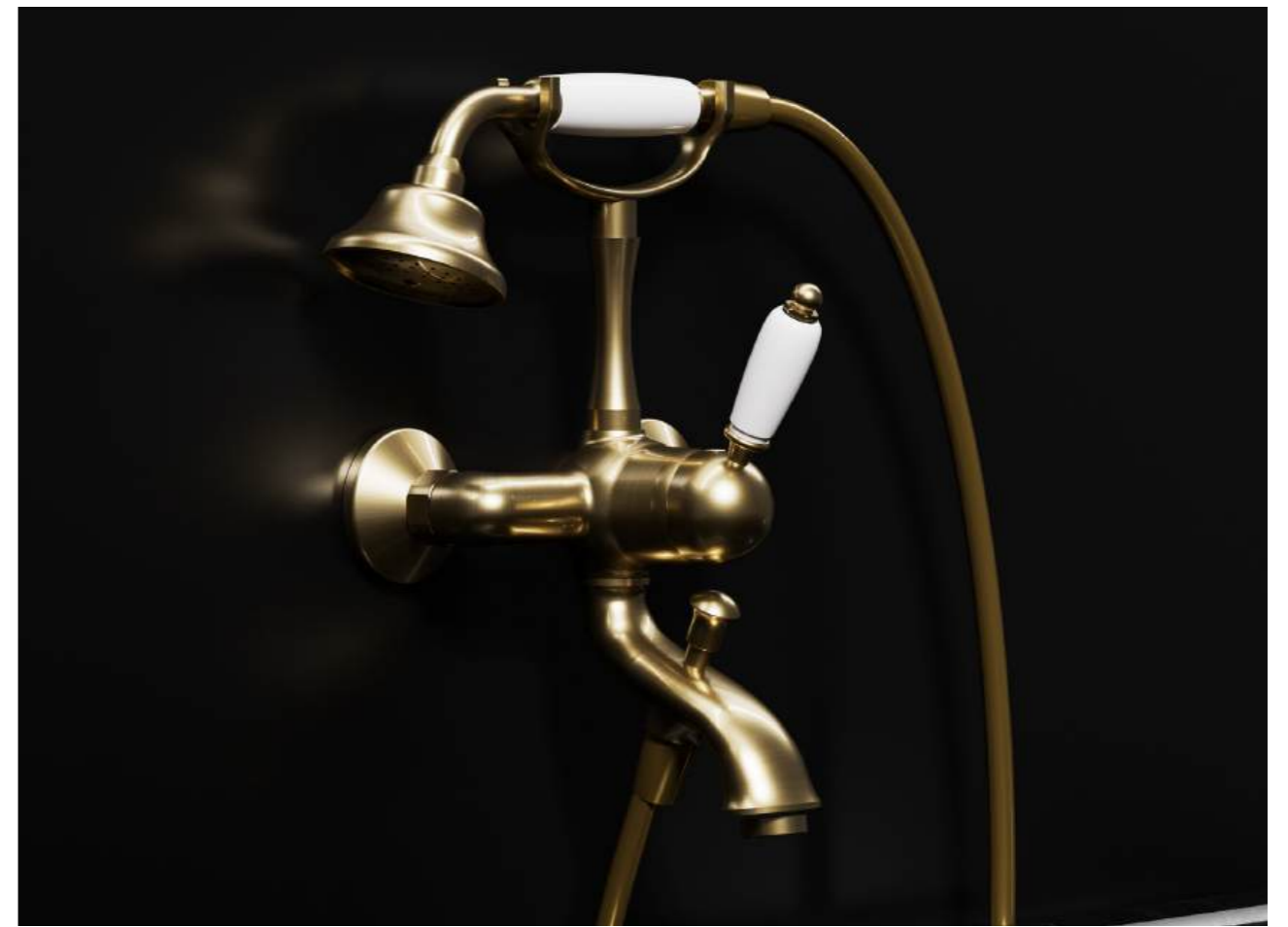
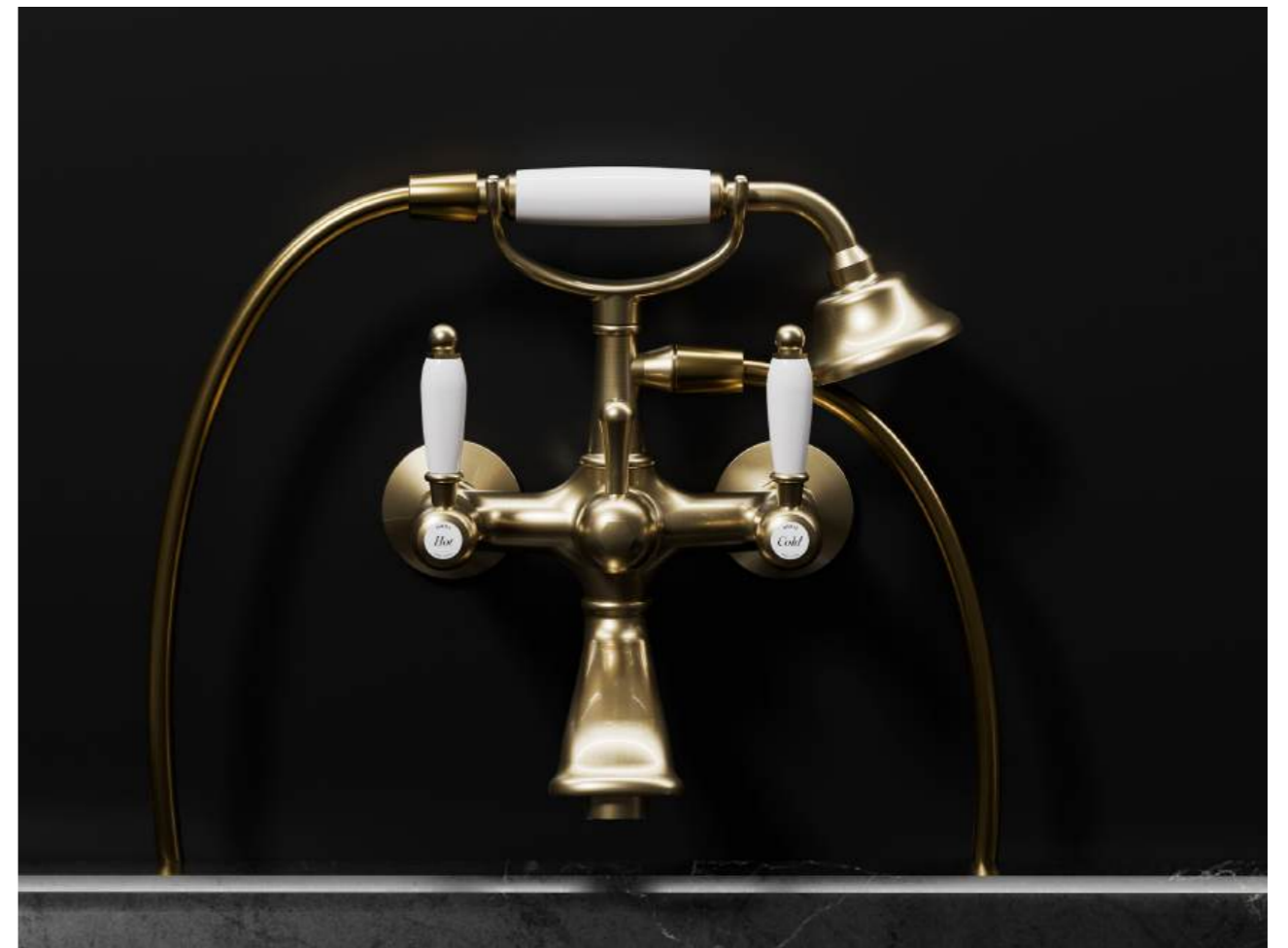
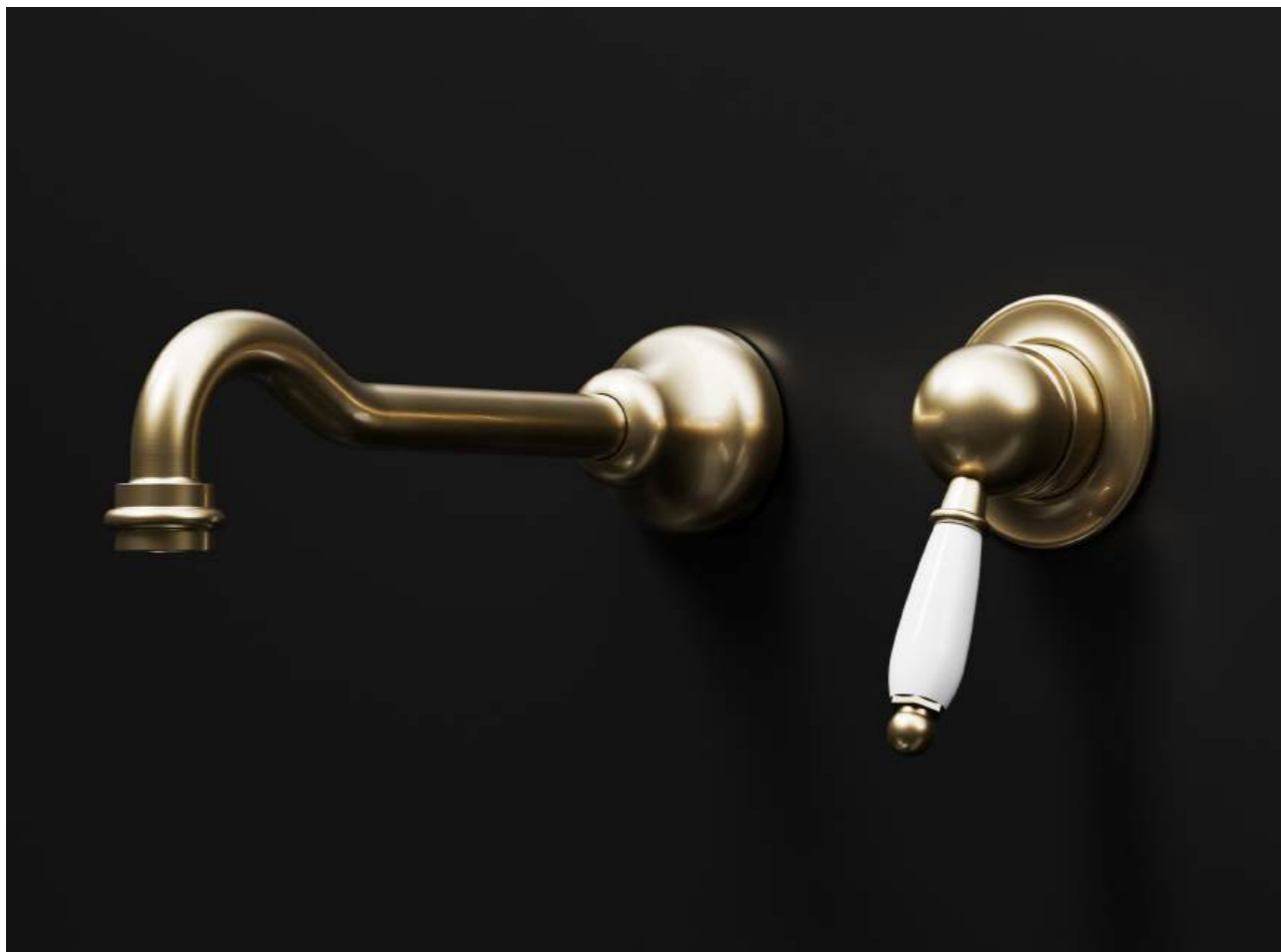
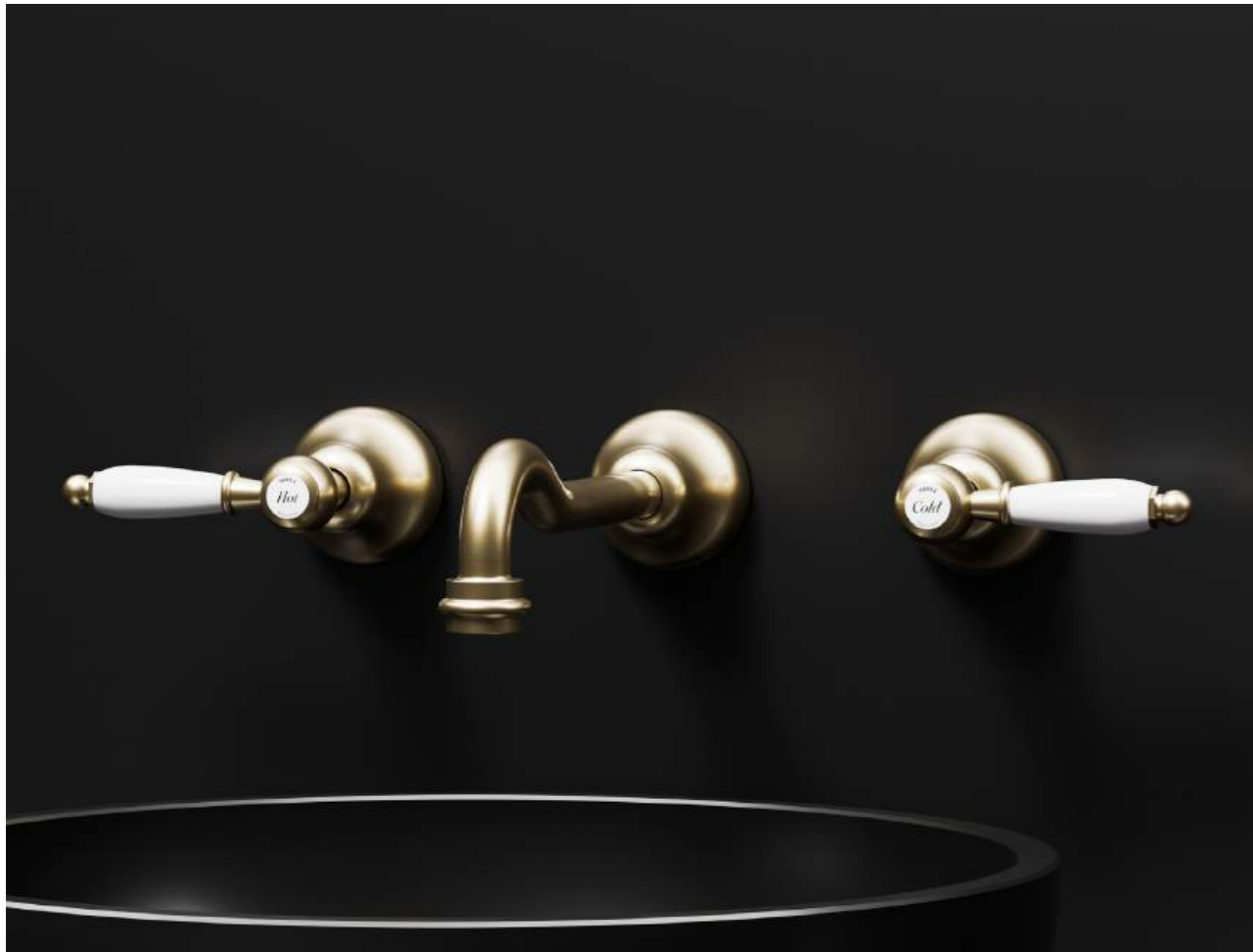

L O N D O N

"Heritage in every detail."





ARCANA

ARCANA embodies the quiet allure of classical design, where tradition and craftsmanship merge in timeless harmony. Inspired by antique forms and refined proportions, the collection brings depth and character to the most elegant bathroom interiors.

Its brushed copper finish enhances every detail with warmth and sophistication. Softly luminous, rich in texture, it evokes the charm of heritage materials reinterpreted for contemporary living.

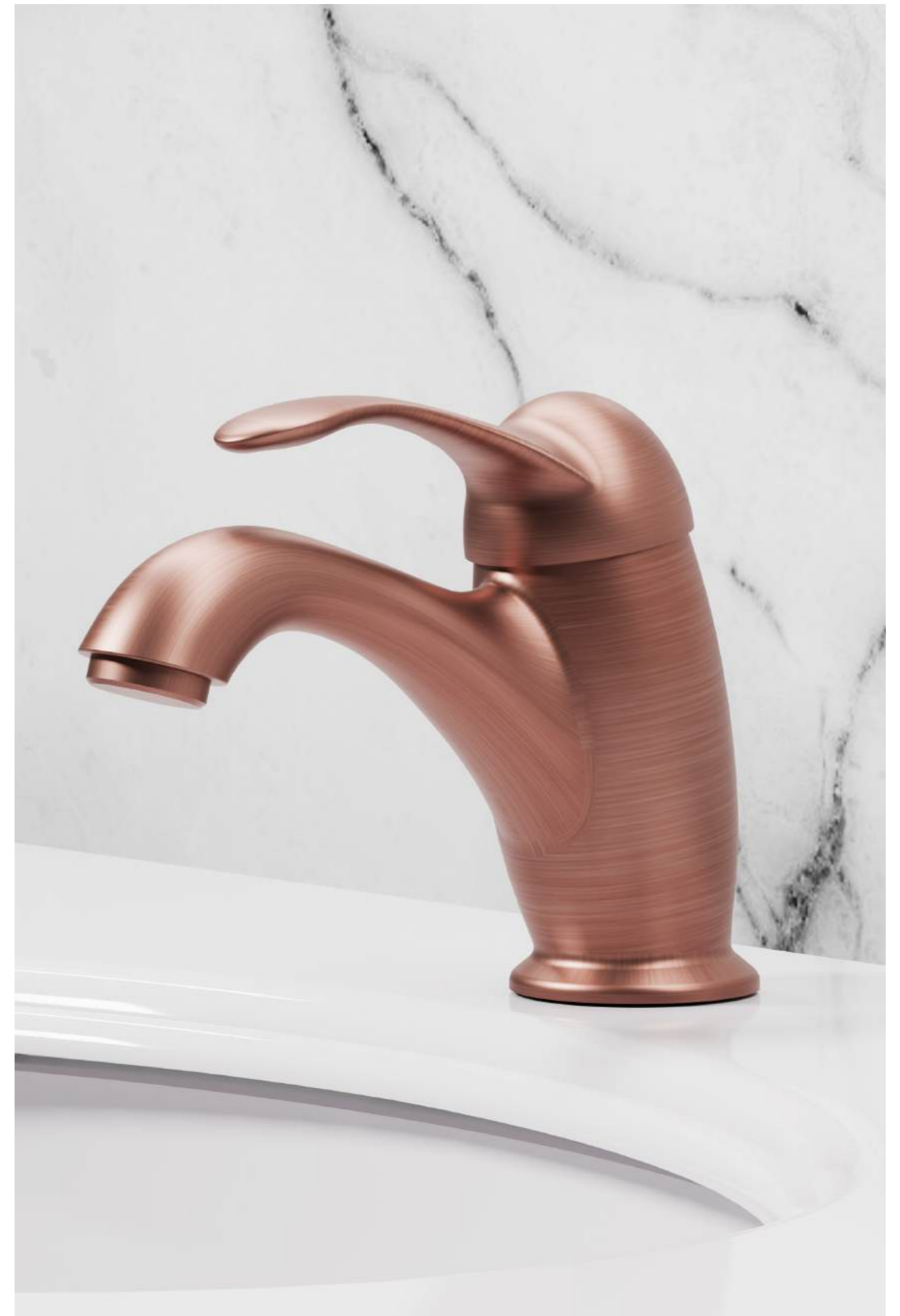

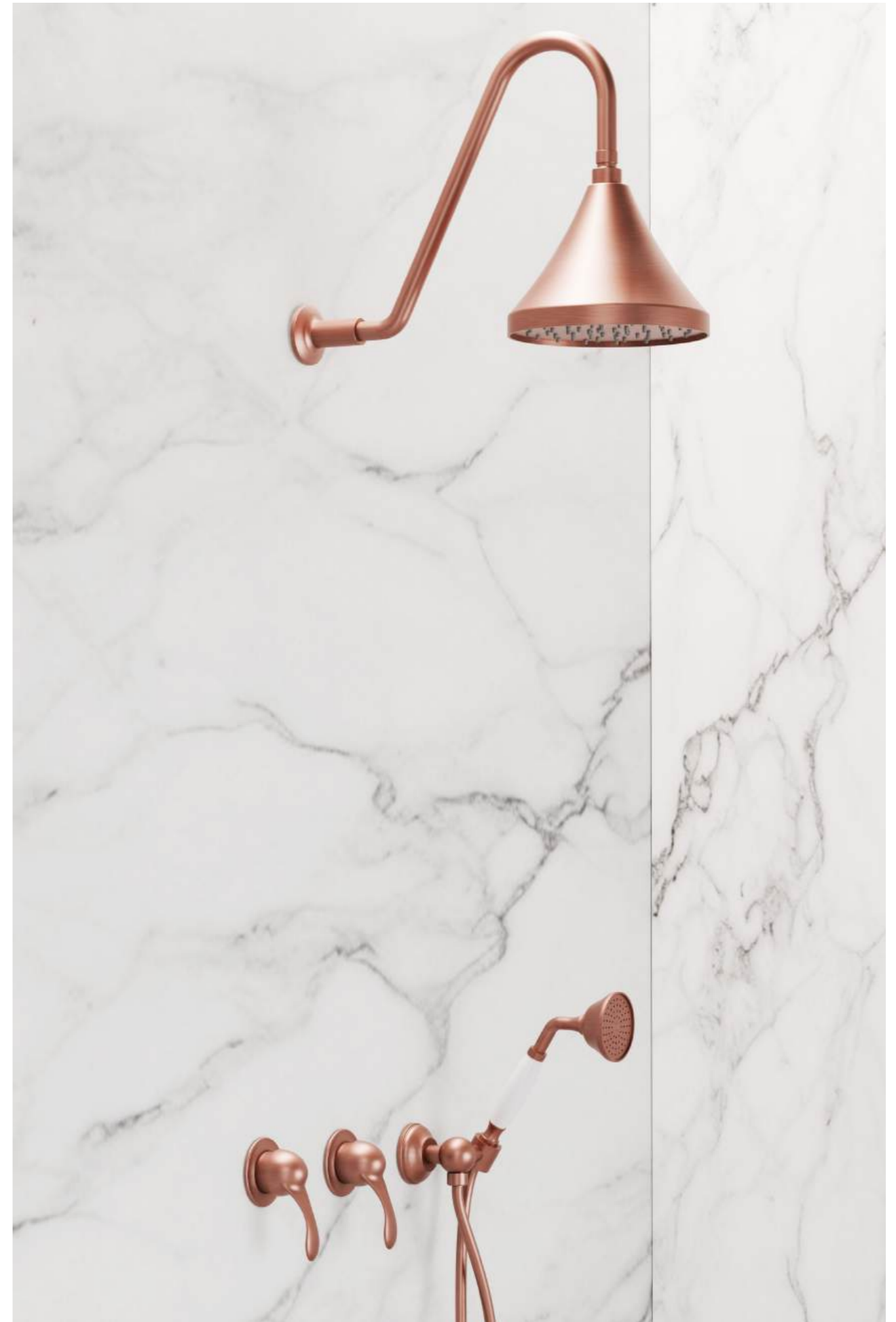

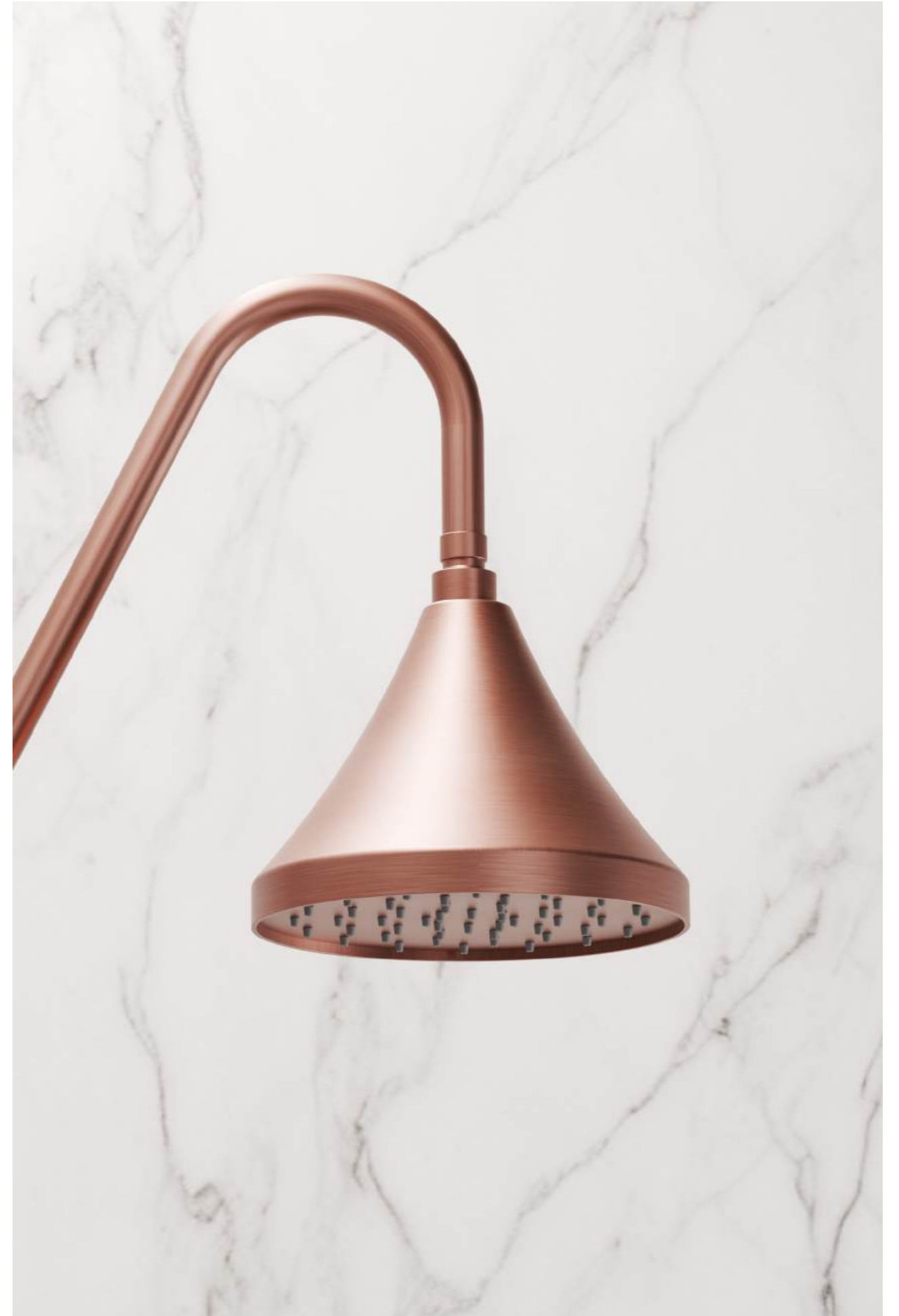

LIBERTY

Classic balance

LIBERTY expresses the purity of traditional design through soft, flowing curves and finely proportioned details. Its gently arched spout and cross handles recall the elegance of classic bathroom fittings, reinterpreted with a refined, contemporary touch.

Liberty is a celebration of timeless style, where heritage inspiration meets solid craftsmanship and enduring functionality.





LIBERTY



446

LIBERTY



447

ROME

ROME is a tribute to the timeless grandeur of the Eternal City. Inspired by classical architecture and the harmonious proportions of ancient Roman design, the collection brings dignity and balance to traditional bathroom interiors.

Its sculpted lines recall the strength of stone, the elegance of columns, and the enduring beauty of historic monuments. Every detail is thoughtfully crafted to evoke heritage, refinement and permanence.

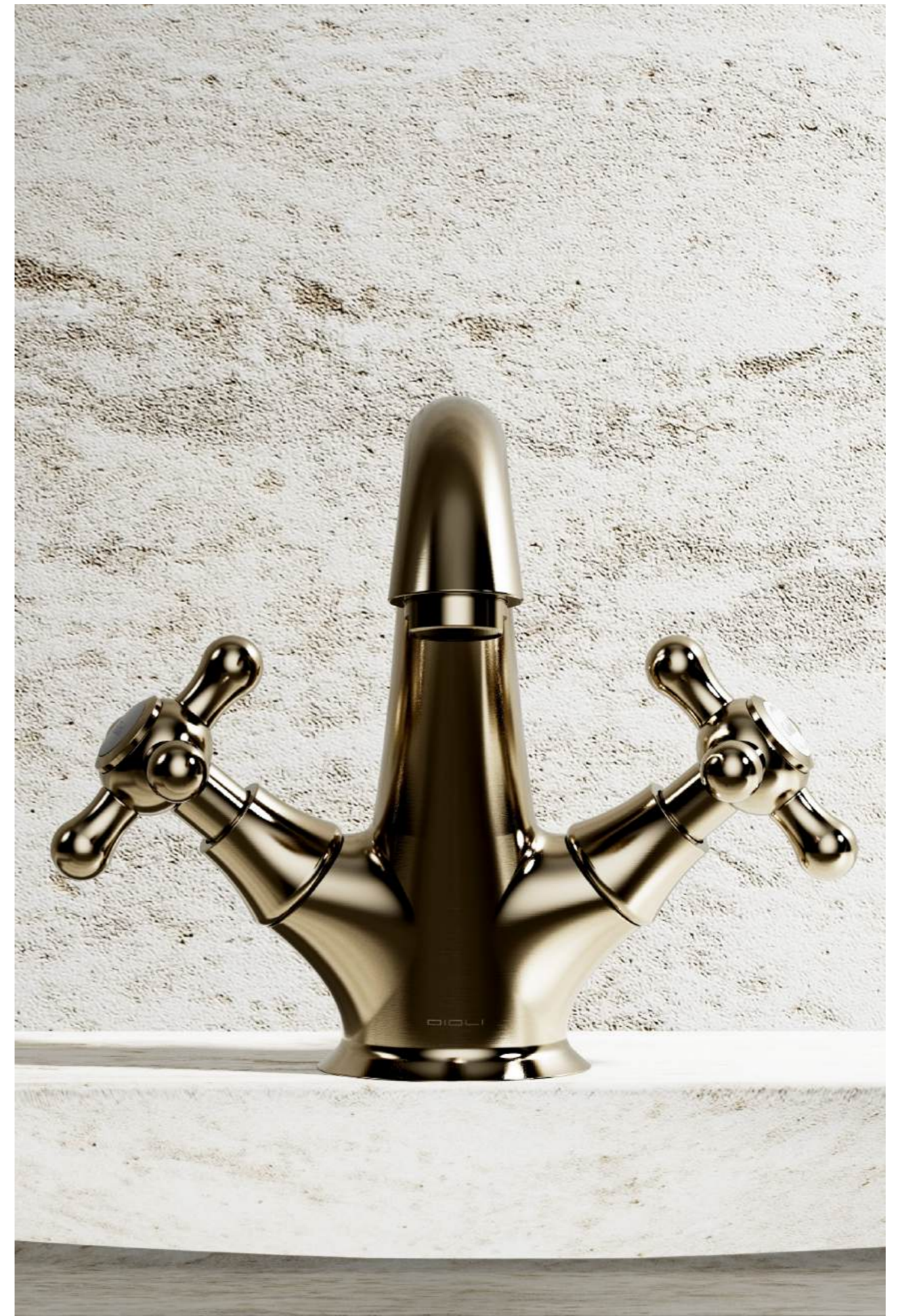



450

ROME



451

R O M E

"Where classical heritage becomes design."





MELODY

MELODY is a celebration of classical elegance, where form and function move in perfect harmony. Inspired by timeless design, the collection brings balance and refinement to traditional bathroom interiors.

Its distinctive lever becomes the defining element of the composition a graceful detail that enhances the overall silhouette and adds rhythm to the space. Each curve is carefully proportioned, creating a sense of continuity and visual serenity.

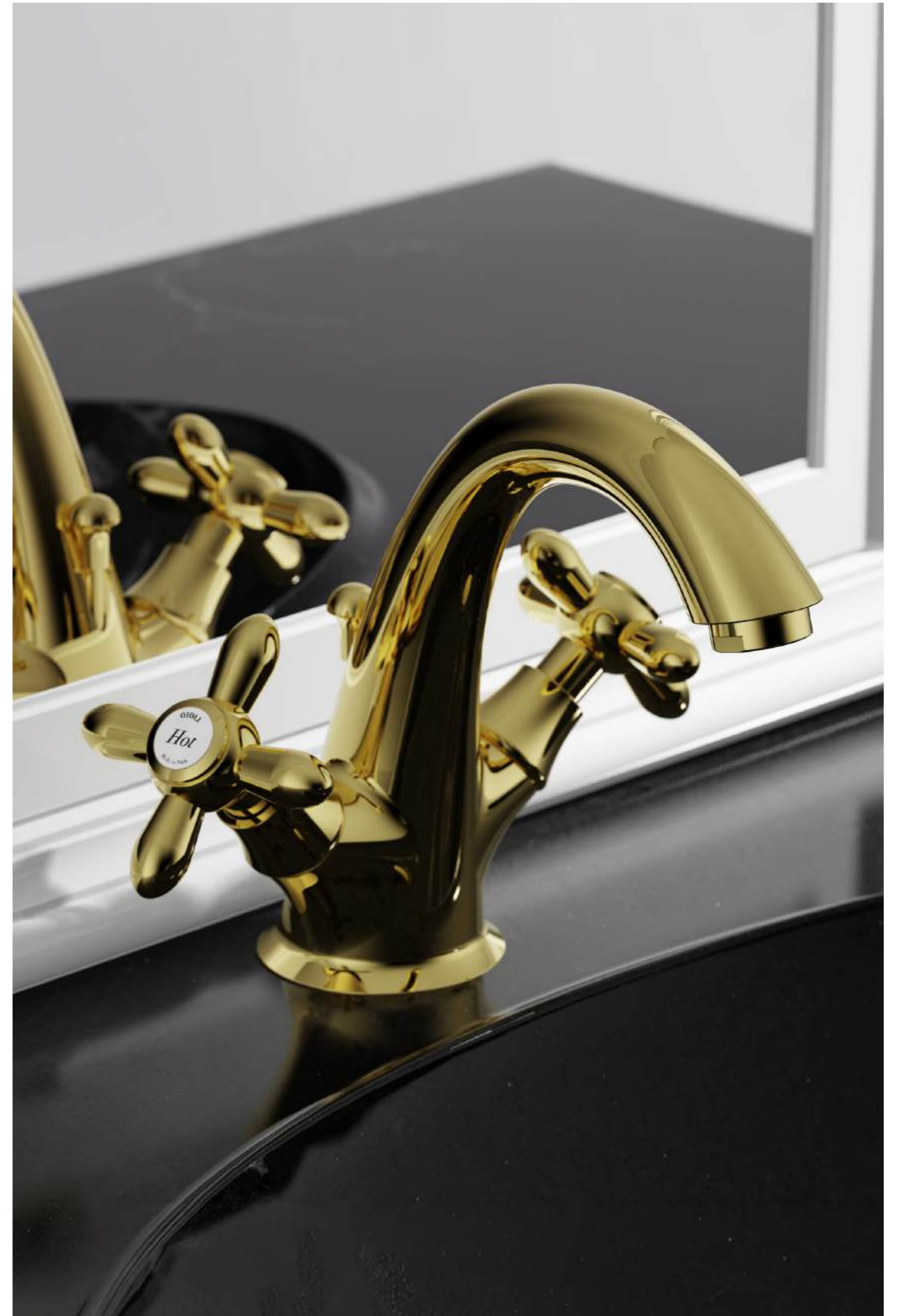





KITCHEN

316 Stainless Steel

The **kitchen** is the space where precision meets creativity.
A place of movement, light and material authenticity.

Our brushed stainless steel collection celebrates purity of form and technical excellence. Defined by clean lines and refined surfaces, each piece is designed to combine durability with understated elegance.



KITCHEN



464

KITCHEN



465

KITCHEN

“Exquisite stainless steel, sculpted to embody timeless sophistication and elevate the kitchen to a statement of pure luxury.”



KITCHEN



468

KITCHEN



469

KITCHEN

"A masterpiece in stainless steel where impeccable craftsmanship and luminous surfaces define an uncompromising standard of elegance."



KITCHEN



472

KITCHEN



473

KITCHEN

"Where stainless steel meets elegance of form."



KITCHEN



476

KITCHEN



477

KITCHEN

The **KITCHEN** is no longer just a space.
It is the heart of the home.

Where design meets movement.
Where function becomes ritual.

Our kitchen collection is conceived to elevate the everyday, balancing precision engineering with refined aesthetics. Clean lines, sculpted forms, and timeless finishes come together to create objects that are both purposeful and expressive.

Because in the most lived-in space of the home, every detail matters.







KITCHEN

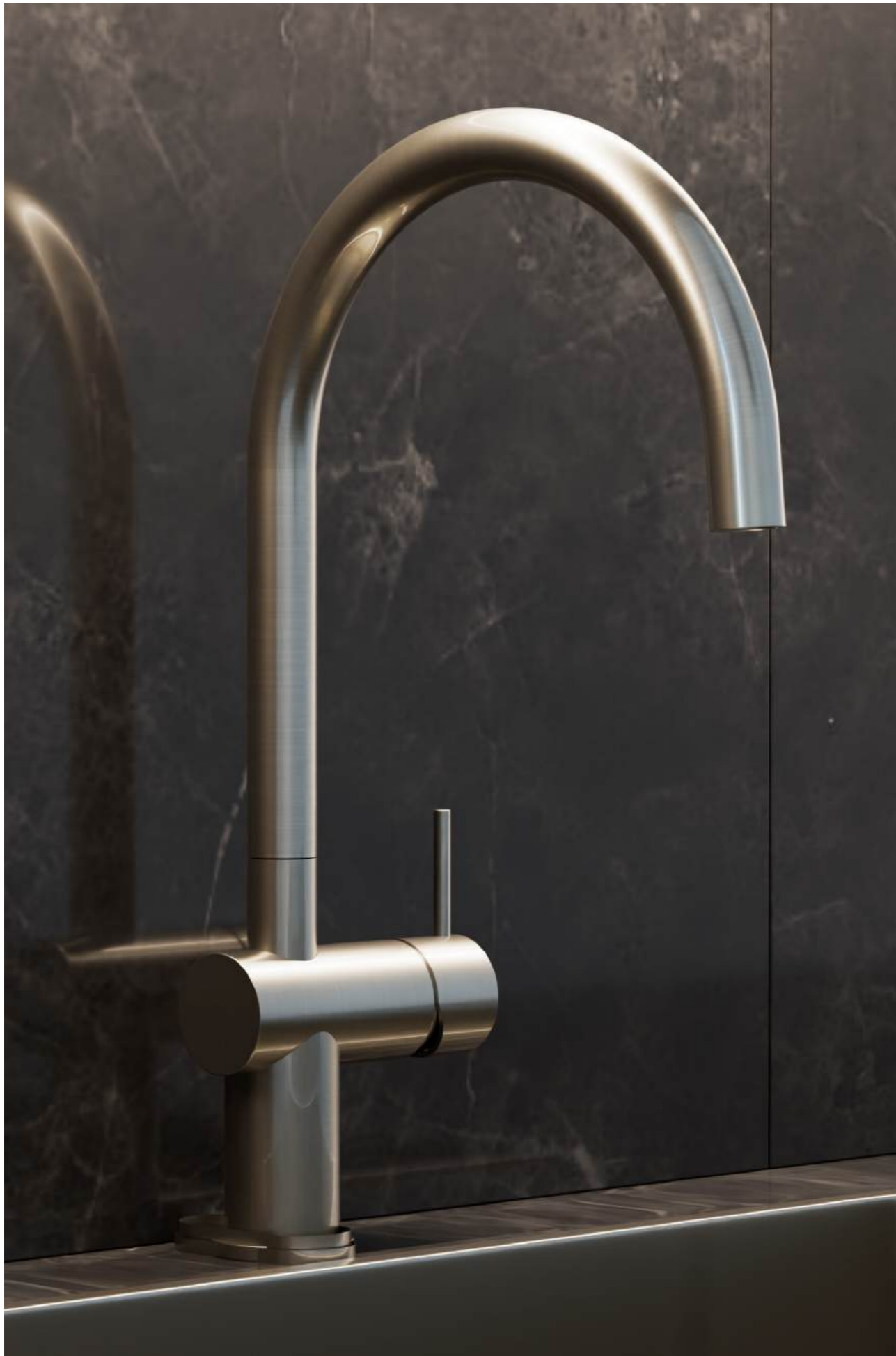

484

KITCHEN



485

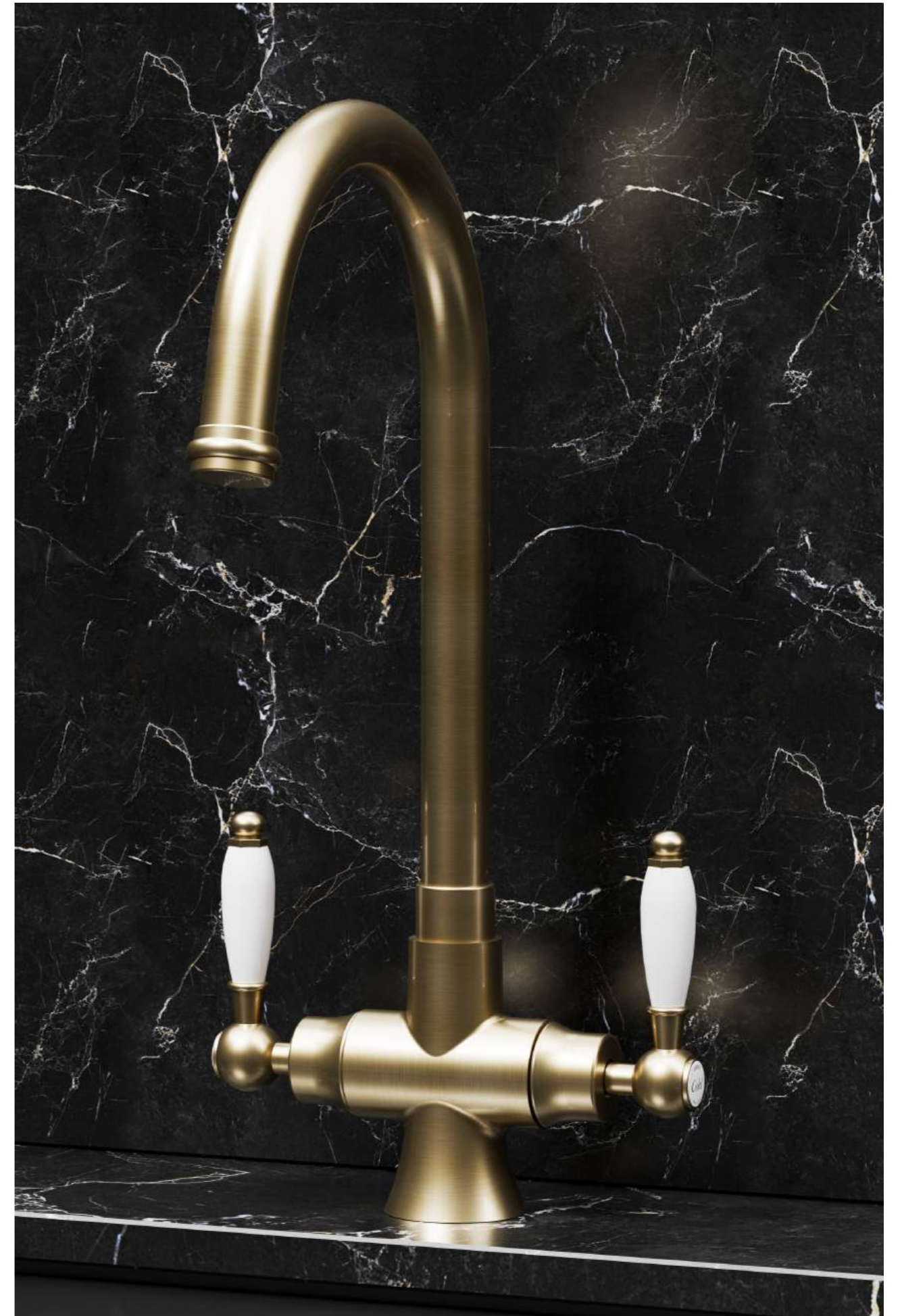

03-2026

OIOLI

The colors, finishes, and product representations shown herein are for illustrative purposes only and may vary from the actual products.
We reserve the right to correct any errors, inaccuracies, or misprints in the current catalogue at any time without prior notice.
Such errors shall not constitute grounds for any claim or dispute.
For further information or clarification, please contact us directly.

OIOLI RUBINETTERIE S.r.l.

Via Pul Stretta 10/12
28024 Gozzano (NO) - Italy

vendite@oioli.com
sales@oioli.com
+39 0322956338

www.oioli.com

SHOWROOM

Via Goito 3, Milano - Italy

